

Firestone



TIRE DATA BOOK

EFFECTIVE MARCH 2021 | VERSION 2.0

HOW TO USE THE DATA BOOK

MAXI TRACTION — R-1W

1. In the tread depth provides improved wear rate volume. Curved bar optimizes wear.*

2. F- and V-optimized sipes technology, which helps farmers carry heavier loads and reduce tire wear. The tread is designed to provide an elongated life of use and reduced soil compaction.

3. In the tread depth to provide a more comfortable ride.

4. Sipes bar taper for improved irregular wear resistance and a more comfortable ride.

TIRE SIZE	METRIC LOAD INDEX	TIRE WIDTH	MAXI TRACTION (psi)										CONTACT AREA (sq. in.)	MAX. LOAD (lb.)			
			15.00	16.00	17.00	18.00	19.00	20.00	21.00	22.00	23.00	24.00					
435/70R14	00057L	135	0	15.00	16.00	17.00	18.00	19.00	20.00	21.00	22.00	23.00	24.00	42	1,94	227	5000R14
435/70R16	01184L	145	0	15.00	17.00	18.00	19.00	20.00	21.00	22.00	23.00	24.00	42	2,18	251	6000R16	
480/70R16	01196L	154	0	15.00	18.00	19.00	20.00	21.00	22.00	23.00	24.00	42	2,34	264	7000R16		
VP675/70R16	00011L	155	0	18.00	19.00	20.00	21.00	22.00	23.00	24.00	25.00	48	2,34	264	2540R16		
VP675/70R18	00017L	165	0	18.00	19.00	20.00	21.00	22.00	23.00	24.00	25.00	48	2,18	251	3250R18		
600/70R18	00034L	175	0	20.00	21.00	22.00	23.00	24.00	25.00	26.00	27.00	50	2,40	270	4300R18		
650/70R18	00070L	185	0	20.00	21.00	22.00	23.00	24.00	25.00	26.00	27.00	50	2,40	270	5100R18		
VP80/70R18C1	00020L	185	0	20.00	21.00	22.00	23.00	24.00	25.00	26.00	27.00	50	2,40	270	2540R18		
750/70R18	00048L	195	0	22.00	23.00	24.00	25.00	26.00	27.00	28.00	29.00	54	2,50	280	3250R18		
850/70R18	00078L	210	0	22.00	23.00	24.00	25.00	26.00	27.00	28.00	29.00	54	2,50	280	5100R18		
VP10/70R18C1	00038L	204	0	22.00	23.00	24.00	25.00	26.00	27.00	28.00	29.00	54	2,50	280	3250R18		
VP10/70R18C2	00038L	204	0	22.00	23.00	24.00	25.00	26.00	27.00	28.00	29.00	54	2,50	280	3250R18		
PI100/70R18C1	00402L	187	0	18.00	19.00	20.00	21.00	22.00	23.00	24.00	25.00	48	2,27	257	2850R18		
435/70R16	00036L	145	0	20.00	21.00	22.00	23.00	24.00	25.00	26.00	27.00	50	2,30	260	3250R16		
VP10/70R16	00447L	178	0	21.00	22.00	23.00	24.00	25.00	26.00	27.00	28.00	50	2,34	264	5100R16		

* Comparison based upon MaxTrac Traction vs. Firestone Radial All Traction CF from internal testing. Results may vary.
 † Additional from previous data book.
 See Current Farm Tire Information, Approved Ret Cordures (pages 165-172) for a listing of approved ret cordures by the size.
 See Load & Inflation Tables (pages 52-163) for more details.
 P. 8 of 21 (2012) Firestone

FINDING A TIRE

There are two ways to find specific tire information. Do you know the size you need, and want to see what is available? The first reference guide is sorted by tire size for all active and discontinued patterns listed in the data book. Simply look up the size you are interested in and go to the page you need.

If you are interested in details about certain patterns, or where to find load and inflation tables, or other general tire and warranty information, the table of contents is the reference guide to use.

TIRE DETAIL PAGES

Tire data can be located utilizing the individual tabs found on the outside edge of each page. Tabs break down specific patterns based on **RADIAL FARM, BIAS FARM, FRONTS & IMPLEMENTS, FORESTRY,** and **DISCONTINUED.**

Each pattern page includes:

1. An image of the tire
2. General marketing benefits
3. The typical equipment on which a pattern could be used depending on the size needed. The equipment icons are represented below.
4. Dimensional and load data for all sizes available within the given pattern

ICON	EQUIPMENT
	TRACK
	SPRAYER
	COMPACT TRACTOR
	ROW-CROP TRACTOR
	IRRIGATION
	GRAIN CART

ICON	EQUIPMENT
	FRONTS
	FORESTRY SKIDDER
	FELLER BUNCHER
	HARVEST
	4WD TRACTOR
	IMPLEMENTS

HOW TO USE THE DATA BOOK

Tires that have been discontinued within the last five years are also found under the appropriate tab. Discontinued tires are defined as tires that are no longer being produced in any of the designated Firestone ag production facilities. This information is provided to aid in viewing important technical data necessary for adjustments or when matching to new tire patterns.

TABLE A – RADIAL PLY AGRICULTURAL TRACTOR DRIVE WHEEL TIRES

TIRE TYPE NOMENCLATURE		MAX SPEED	
TRA	TIRE TYPE	MPH	KPH
B-10	Class 1 Wheel, Super Tread	55 mph	88 km/h
B-15	Class 1 Wheel, Max Traction Tread	55 mph	88 km/h
B-20	Class 2 Plus, SuperTread Tread Pattern	55 mph	88 km/h

BASIC TIRE LOAD RATINGS FOR TIRE SELECTION
METRIC (ENGLISH UNITS OF MEASURE) (SI/US)

TIRE SIZE	INFLATION	LOAD LIMITS AT VARIOUS COOL INFLATION PRESSURES																																																																																																																																																																																																																																																																																																																																																																																																																																																																																																																																																																																																																																																																																																																																																																																																																																																																																																																					
		PSI	40	60	70	80	100	110	120	140	150	160	180	200	220																																																																																																																																																																																																																																																																																																																																																																																																																																																																																																																																																																																																																																																																																																																																																																																																																																																																																																								
<table border="1"> <thead> <tr> <th colspan="15">LOAD LIMITS AT VARIOUS COOL INFLATION PRESSURES (KILOGRAMS)</th> </tr> <tr> <th>TIRE SIZE</th> <th>INFLATION</th> <th>PSI</th> <th>40</th> <th>60</th> <th>70</th> <th>80</th> <th>100</th> <th>110</th> <th>120</th> <th>140</th> <th>150</th> <th>160</th> <th>180</th> <th>200</th> <th>220</th> </tr> </thead> <tbody> <tr> <td rowspan="3">11.00R14</td> <td rowspan="3">S</td> <td>30</td> <td>300</td> <td>300</td> <td>300</td> <td>300</td> <td>300</td> <td>300</td> <td>300</td> <td>300</td> <td>300</td> <td>300</td> <td>300</td> <td>300</td> <td>300</td> </tr> <tr> <td>40</td> <td>300</td> <td>300</td> <td>300</td> <td>300</td> <td>300</td> <td>300</td> <td>300</td> <td>300</td> <td>300</td> <td>300</td> <td>300</td> <td>300</td> <td>300</td> </tr> <tr> <td>50</td> <td>300</td> <td>300</td> <td>300</td> <td>300</td> <td>300</td> <td>300</td> <td>300</td> <td>300</td> <td>300</td> <td>300</td> <td>300</td> <td>300</td> <td>300</td> </tr> <tr> <td rowspan="3">11.00R16</td> <td rowspan="3">S</td> <td>30</td> <td>300</td> <td>300</td> <td>300</td> <td>300</td> <td>300</td> <td>300</td> <td>300</td> <td>300</td> <td>300</td> <td>300</td> <td>300</td> <td>300</td> <td>300</td> </tr> <tr> <td>40</td> <td>300</td> <td>300</td> <td>300</td> <td>300</td> <td>300</td> <td>300</td> <td>300</td> <td>300</td> <td>300</td> <td>300</td> <td>300</td> <td>300</td> </tr> <tr> <td>50</td> <td>300</td> <td>300</td> <td>300</td> <td>300</td> <td>300</td> <td>300</td> <td>300</td> <td>300</td> <td>300</td> <td>300</td> <td>300</td> <td>300</td> </tr> <tr> <td rowspan="3">12.00R16</td> <td rowspan="3">S</td> <td>30</td> <td>300</td> <td>300</td> <td>300</td> <td>300</td> <td>300</td> <td>300</td> <td>300</td> <td>300</td> <td>300</td> <td>300</td> <td>300</td> <td>300</td> <td>300</td> </tr> <tr> <td>40</td> <td>300</td> <td>300</td> <td>300</td> <td>300</td> <td>300</td> <td>300</td> <td>300</td> <td>300</td> <td>300</td> <td>300</td> <td>300</td> <td>300</td> </tr> <tr> <td>50</td> <td>300</td> <td>300</td> <td>300</td> <td>300</td> <td>300</td> <td>300</td> <td>300</td> <td>300</td> <td>300</td> <td>300</td> <td>300</td> <td>300</td> </tr> <tr> <td rowspan="3">12.00R18</td> <td rowspan="3">S</td> <td>30</td> <td>300</td> <td>300</td> <td>300</td> <td>300</td> <td>300</td> <td>300</td> <td>300</td> <td>300</td> <td>300</td> <td>300</td> <td>300</td> <td>300</td> <td>300</td> </tr> <tr> <td>40</td> <td>300</td> <td>300</td> <td>300</td> <td>300</td> <td>300</td> <td>300</td> <td>300</td> <td>300</td> <td>300</td> <td>300</td> <td>300</td> <td>300</td> </tr> <tr> <td>50</td> <td>300</td> <td>300</td> <td>300</td> <td>300</td> <td>300</td> <td>300</td> <td>300</td> <td>300</td> <td>300</td> <td>300</td> <td>300</td> <td>300</td> </tr> <tr> <td rowspan="3">12.00R20</td> <td rowspan="3">S</td> <td>30</td> <td>300</td> <td>300</td> <td>300</td> <td>300</td> <td>300</td> <td>300</td> <td>300</td> <td>300</td> <td>300</td> <td>300</td> <td>300</td> <td>300</td> <td>300</td> </tr> <tr> <td>40</td> <td>300</td> <td>300</td> <td>300</td> <td>300</td> <td>300</td> <td>300</td> <td>300</td> <td>300</td> <td>300</td> <td>300</td> <td>300</td> <td>300</td> </tr> <tr> <td>50</td> <td>300</td> <td>300</td> <td>300</td> <td>300</td> <td>300</td> <td>300</td> <td>300</td> <td>300</td> <td>300</td> <td>300</td> <td>300</td> <td>300</td> </tr> <tr> <td rowspan="3">12.00R22</td> <td rowspan="3">S</td> <td>30</td> <td>300</td> <td>300</td> <td>300</td> <td>300</td> <td>300</td> <td>300</td> <td>300</td> <td>300</td> <td>300</td> <td>300</td> <td>300</td> <td>300</td> <td>300</td> </tr> <tr> <td>40</td> <td>300</td> <td>300</td> <td>300</td> <td>300</td> <td>300</td> <td>300</td> <td>300</td> <td>300</td> <td>300</td> <td>300</td> <td>300</td> <td>300</td> </tr> <tr> <td>50</td> <td>300</td> <td>300</td> <td>300</td> <td>300</td> <td>300</td> <td>300</td> <td>300</td> <td>300</td> <td>300</td> <td>300</td> <td>300</td> <td>300</td> </tr> <tr> <td rowspan="3">12.00R24</td> <td rowspan="3">S</td> <td>30</td> <td>300</td> <td>300</td> <td>300</td> <td>300</td> <td>300</td> <td>300</td> <td>300</td> <td>300</td> <td>300</td> <td>300</td> <td>300</td> <td>300</td> <td>300</td> </tr> <tr> <td>40</td> <td>300</td> <td>300</td> <td>300</td> <td>300</td> <td>300</td> <td>300</td> <td>300</td> <td>300</td> <td>300</td> <td>300</td> <td>300</td> <td>300</td> </tr> <tr> <td>50</td> <td>300</td> <td>300</td> <td>300</td> <td>300</td> <td>300</td> <td>300</td> <td>300</td> <td>300</td> <td>300</td> <td>300</td> <td>300</td> <td>300</td> </tr> <tr> <td rowspan="3">12.00R26</td> <td rowspan="3">S</td> <td>30</td> <td>300</td> <td>300</td> <td>300</td> <td>300</td> <td>300</td> <td>300</td> <td>300</td> <td>300</td> <td>300</td> <td>300</td> <td>300</td> <td>300</td> <td>300</td> </tr> <tr> <td>40</td> <td>300</td> <td>300</td> <td>300</td> <td>300</td> <td>300</td> <td>300</td> <td>300</td> <td>300</td> <td>300</td> <td>300</td> <td>300</td> <td>300</td> </tr> <tr> <td>50</td> <td>300</td> <td>300</td> <td>300</td> <td>300</td> <td>300</td> <td>300</td> <td>300</td> <td>300</td> <td>300</td> <td>300</td> <td>300</td> <td>300</td> </tr> <tr> <td rowspan="3">12.00R28</td> <td rowspan="3">S</td> <td>30</td> <td>300</td> <td>300</td> <td>300</td> <td>300</td> <td>300</td> <td>300</td> <td>300</td> <td>300</td> <td>300</td> <td>300</td> <td>300</td> <td>300</td> <td>300</td> </tr> <tr> <td>40</td> <td>300</td> <td>300</td> <td>300</td> <td>300</td> <td>300</td> <td>300</td> <td>300</td> <td>300</td> <td>300</td> <td>300</td> <td>300</td> <td>300</td> </tr> <tr> <td>50</td> <td>300</td> <td>300</td> <td>300</td> <td>300</td> <td>300</td> <td>300</td> <td>300</td> <td>300</td> <td>300</td> <td>300</td> <td>300</td> <td>300</td> </tr> <tr> <td rowspan="3">12.00R30</td> <td rowspan="3">S</td> <td>30</td> <td>300</td> <td>300</td> <td>300</td> <td>300</td> <td>300</td> <td>300</td> <td>300</td> <td>300</td> <td>300</td> <td>300</td> <td>300</td> <td>300</td> <td>300</td> </tr> <tr> <td>40</td> <td>300</td> <td>300</td> <td>300</td> <td>300</td> <td>300</td> <td>300</td> <td>300</td> <td>300</td> <td>300</td> <td>300</td> <td>300</td> <td>300</td> </tr> <tr> <td>50</td> <td>300</td> <td>300</td> <td>300</td> <td>300</td> <td>300</td> <td>300</td> <td>300</td> <td>300</td> <td>300</td> <td>300</td> <td>300</td> <td>300</td> </tr> <tr> <td rowspan="3">12.00R32</td> <td rowspan="3">S</td> <td>30</td> <td>300</td> <td>300</td> <td>300</td> <td>300</td> <td>300</td> <td>300</td> <td>300</td> <td>300</td> <td>300</td> <td>300</td> <td>300</td> <td>300</td> <td>300</td> </tr> <tr> <td>40</td> <td>300</td> <td>300</td> <td>300</td> <td>300</td> <td>300</td> <td>300</td> <td>300</td> <td>300</td> <td>300</td> <td>300</td> <td>300</td> <td>300</td> </tr> <tr> <td>50</td> <td>300</td> <td>300</td> <td>300</td> <td>300</td> <td>300</td> <td>300</td> <td>300</td> <td>300</td> <td>300</td> <td>300</td> <td>300</td> <td>300</td> </tr> <tr> <td rowspan="3">12.00R34</td> <td rowspan="3">S</td> <td>30</td> <td>300</td> <td>300</td> <td>300</td> <td>300</td> <td>300</td> <td>300</td> <td>300</td> <td>300</td> <td>300</td> <td>300</td> <td>300</td> <td>300</td> <td>300</td> </tr> <tr> <td>40</td> <td>300</td> <td>300</td> <td>300</td> <td>300</td> <td>300</td> <td>300</td> <td>300</td> <td>300</td> <td>300</td> <td>300</td> <td>300</td> <td>300</td> </tr> <tr> <td>50</td> <td>300</td> <td>300</td> <td>300</td> <td>300</td> <td>300</td> <td>300</td> <td>300</td> <td>300</td> <td>300</td> <td>300</td> <td>300</td> <td>300</td> </tr> <tr> <td rowspan="3">12.00R36</td> <td rowspan="3">S</td> <td>30</td> <td>300</td> <td>300</td> <td>300</td> <td>300</td> <td>300</td> <td>300</td> <td>300</td> <td>300</td> <td>300</td> <td>300</td> <td>300</td> <td>300</td> <td>300</td> </tr> <tr> <td>40</td> <td>300</td> <td>300</td> <td>300</td> <td>300</td> <td>300</td> <td>300</td> <td>300</td> <td>300</td> <td>300</td> <td>300</td> <td>300</td> <td>300</td> </tr> <tr> <td>50</td> <td>300</td> <td>300</td> <td>300</td> <td>300</td> <td>300</td> <td>300</td> <td>300</td> <td>300</td> <td>300</td> <td>300</td> <td>300</td> <td>300</td> </tr> <tr> <td rowspan="3">12.00R38</td> <td rowspan="3">S</td> <td>30</td> <td>300</td> <td>300</td> <td>300</td> <td>300</td> <td>300</td> <td>300</td> <td>300</td> <td>300</td> <td>300</td> <td>300</td> <td>300</td> <td>300</td> <td>300</td> </tr> <tr> <td>40</td> <td>300</td> <td>300</td> <td>300</td> <td>300</td> <td>300</td> <td>300</td> <td>300</td> <td>300</td> <td>300</td> <td>300</td> <td>300</td> <td>300</td> </tr> <tr> <td>50</td> <td>300</td> <td>300</td> <td>300</td> <td>300</td> <td>300</td> <td>300</td> <td>300</td> <td>300</td> <td>300</td> <td>300</td> <td>300</td> <td>300</td> </tr> <tr> <td rowspan="3">12.00R40</td> <td rowspan="3">S</td> <td>30</td> <td>300</td> <td>300</td> <td>300</td> <td>300</td> <td>300</td> <td>300</td> <td>300</td> <td>300</td> <td>300</td> <td>300</td> <td>300</td> <td>300</td> <td>300</td> </tr> <tr> <td>40</td> <td>300</td> <td>300</td> <td>300</td> <td>300</td> <td>300</td> <td>300</td> <td>300</td> <td>300</td> <td>300</td> <td>300</td> <td>300</td> <td>300</td> </tr> <tr> <td>50</td> <td>300</td> <td>300</td> <td>300</td> <td>300</td> <td>300</td> <td>300</td> <td>300</td> <td>300</td> <td>300</td> <td>300</td> <td>300</td> <td>300</td> </tr> <tr> <td rowspan="3">12.00R42</td> <td rowspan="3">S</td> <td>30</td> <td>300</td> <td>300</td> <td>300</td> <td>300</td> <td>300</td> <td>300</td> <td>300</td> <td>300</td> <td>300</td> <td>300</td> <td>300</td> <td>300</td> <td>300</td> </tr> <tr> <td>40</td> <td>300</td> <td>300</td> <td>300</td> <td>300</td> <td>300</td> <td>300</td> <td>300</td> <td>300</td> <td>300</td> <td>300</td> <td>300</td> <td>300</td> </tr> <tr> <td>50</td> <td>300</td> <td>300</td> <td>300</td> <td>300</td> <td>300</td> <td>300</td> <td>300</td> <td>300</td> <td>300</td> <td>300</td> <td>300</td> <td>300</td> </tr> <tr> <td rowspan="3">12.00R44</td> <td rowspan="3">S</td> <td>30</td> <td>300</td> <td>300</td> <td>300</td> <td>300</td> <td>300</td> <td>300</td> <td>300</td> <td>300</td> <td>300</td> <td>300</td> <td>300</td> <td>300</td> <td>300</td> </tr> <tr> <td>40</td> <td>300</td> <td>300</td> <td>300</td> <td>300</td> <td>300</td> <td>300</td> <td>300</td> <td>300</td> <td>300</td> <td>300</td> <td>300</td> <td>300</td> </tr> <tr> <td>50</td> <td>300</td> <td>300</td> <td>300</td> <td>300</td> <td>300</td> <td>300</td> <td>300</td> <td>300</td> <td>300</td> <td>300</td> <td>300</td> <td>300</td> </tr> <tr> <td rowspan="3">12.00R46</td> <td rowspan="3">S</td> <td>30</td> <td>300</td> <td>300</td> <td>300</td> <td>300</td> <td>300</td> <td>300</td> <td>300</td> <td>300</td> <td>300</td> <td>300</td> <td>300</td> <td>300</td> <td>300</td> </tr> <tr> <td>40</td> <td>300</td> <td>300</td> <td>300</td> <td>300</td> <td>300</td> <td>300</td> <td>300</td> <td>300</td> <td>300</td> <td>300</td> <td>300</td> <td>300</td> </tr> <tr> <td>50</td> <td>300</td> <td>300</td> <td>300</td> <td>300</td> <td>300</td> <td>300</td> <td>300</td> <td>300</td> <td>300</td> <td>300</td> <td>300</td> <td>300</td> </tr> <tr> <td rowspan="3">12.00R48</td> <td rowspan="3">S</td> <td>30</td> <td>300</td> <td>300</td> <td>300</td> <td>300</td> <td>300</td> <td>300</td> <td>300</td> <td>300</td> <td>300</td> <td>300</td> <td>300</td> <td>300</td> <td>300</td> </tr> <tr> <td>40</td> <td>300</td> <td>300</td> <td>300</td> <td>300</td> <td>300</td> <td>300</td> <td>300</td> <td>300</td> <td>300</td> <td>300</td> <td>300</td> <td>300</td> </tr> <tr> <td>50</td> <td>300</td> <td>300</td> <td>300</td> <td>300</td> <td>300</td> <td>300</td> <td>300</td> <td>300</td> <td>300</td> <td>300</td> <td>300</td> <td>300</td> </tr> <tr> <td rowspan="3">12.00R50</td> <td rowspan="3">S</td> <td>30</td> <td>300</td> <td>300</td> <td>300</td> <td>300</td> <td>300</td> <td>300</td> <td>300</td> <td>300</td> <td>300</td> <td>300</td> <td>300</td> <td>300</td> <td>300</td> </tr> <tr> <td>40</td> <td>300</td> <td>300</td> <td>300</td> <td>300</td> <td>300</td> <td>300</td> <td>300</td> <td>300</td> <td>300</td> <td>300</td> <td>300</td> <td>300</td> </tr> <tr> <td>50</td> <td>300</td> <td>300</td> <td>300</td> <td>300</td> <td>300</td> <td>300</td> <td>300</td> <td>300</td> <td>300</td> <td>300</td> <td>300</td> <td>300</td> </tr> </tbody> </table>															LOAD LIMITS AT VARIOUS COOL INFLATION PRESSURES (KILOGRAMS)															TIRE SIZE	INFLATION	PSI	40	60	70	80	100	110	120	140	150	160	180	200	220	11.00R14	S	30	300	300	300	300	300	300	300	300	300	300	300	300	300	40	300	300	300	300	300	300	300	300	300	300	300	300	300	50	300	300	300	300	300	300	300	300	300	300	300	300	300	11.00R16	S	30	300	300	300	300	300	300	300	300	300	300	300	300	300	40	300	300	300	300	300	300	300	300	300	300	300	300	50	300	300	300	300	300	300	300	300	300	300	300	300	12.00R16	S	30	300	300	300	300	300	300	300	300	300	300	300	300	300	40	300	300	300	300	300	300	300	300	300	300	300	300	50	300	300	300	300	300	300	300	300	300	300	300	300	12.00R18	S	30	300	300	300	300	300	300	300	300	300	300	300	300	300	40	300	300	300	300	300	300	300	300	300	300	300	300	50	300	300	300	300	300	300	300	300	300	300	300	300	12.00R20	S	30	300	300	300	300	300	300	300	300	300	300	300	300	300	40	300	300	300	300	300	300	300	300	300	300	300	300	50	300	300	300	300	300	300	300	300	300	300	300	300	12.00R22	S	30	300	300	300	300	300	300	300	300	300	300	300	300	300	40	300	300	300	300	300	300	300	300	300	300	300	300	50	300	300	300	300	300	300	300	300	300	300	300	300	12.00R24	S	30	300	300	300	300	300	300	300	300	300	300	300	300	300	40	300	300	300	300	300	300	300	300	300	300	300	300	50	300	300	300	300	300	300	300	300	300	300	300	300	12.00R26	S	30	300	300	300	300	300	300	300	300	300	300	300	300	300	40	300	300	300	300	300	300	300	300	300	300	300	300	50	300	300	300	300	300	300	300	300	300	300	300	300	12.00R28	S	30	300	300	300	300	300	300	300	300	300	300	300	300	300	40	300	300	300	300	300	300	300	300	300	300	300	300	50	300	300	300	300	300	300	300	300	300	300	300	300	12.00R30	S	30	300	300	300	300	300	300	300	300	300	300	300	300	300	40	300	300	300	300	300	300	300	300	300	300	300	300	50	300	300	300	300	300	300	300	300	300	300	300	300	12.00R32	S	30	300	300	300	300	300	300	300	300	300	300	300	300	300	40	300	300	300	300	300	300	300	300	300	300	300	300	50	300	300	300	300	300	300	300	300	300	300	300	300	12.00R34	S	30	300	300	300	300	300	300	300	300	300	300	300	300	300	40	300	300	300	300	300	300	300	300	300	300	300	300	50	300	300	300	300	300	300	300	300	300	300	300	300	12.00R36	S	30	300	300	300	300	300	300	300	300	300	300	300	300	300	40	300	300	300	300	300	300	300	300	300	300	300	300	50	300	300	300	300	300	300	300	300	300	300	300	300	12.00R38	S	30	300	300	300	300	300	300	300	300	300	300	300	300	300	40	300	300	300	300	300	300	300	300	300	300	300	300	50	300	300	300	300	300	300	300	300	300	300	300	300	12.00R40	S	30	300	300	300	300	300	300	300	300	300	300	300	300	300	40	300	300	300	300	300	300	300	300	300	300	300	300	50	300	300	300	300	300	300	300	300	300	300	300	300	12.00R42	S	30	300	300	300	300	300	300	300	300	300	300	300	300	300	40	300	300	300	300	300	300	300	300	300	300	300	300	50	300	300	300	300	300	300	300	300	300	300	300	300	12.00R44	S	30	300	300	300	300	300	300	300	300	300	300	300	300	300	40	300	300	300	300	300	300	300	300	300	300	300	300	50	300	300	300	300	300	300	300	300	300	300	300	300	12.00R46	S	30	300	300	300	300	300	300	300	300	300	300	300	300	300	40	300	300	300	300	300	300	300	300	300	300	300	300	50	300	300	300	300	300	300	300	300	300	300	300	300	12.00R48	S	30	300	300	300	300	300	300	300	300	300	300	300	300	300	40	300	300	300	300	300	300	300	300	300	300	300	300	50	300	300	300	300	300	300	300	300	300	300	300	300	12.00R50	S	30	300	300	300	300	300	300	300	300	300	300	300	300	300	40	300	300	300	300	300	300	300	300	300	300	300	300	50	300	300	300	300	300	300	300	300	300	300	300	300
LOAD LIMITS AT VARIOUS COOL INFLATION PRESSURES (KILOGRAMS)																																																																																																																																																																																																																																																																																																																																																																																																																																																																																																																																																																																																																																																																																																																																																																																																																																																																																																																							
TIRE SIZE	INFLATION	PSI	40	60	70	80	100	110	120	140	150	160	180	200	220																																																																																																																																																																																																																																																																																																																																																																																																																																																																																																																																																																																																																																																																																																																																																																																																																																																																																																								
11.00R14	S	30	300	300	300	300	300	300	300	300	300	300	300	300	300																																																																																																																																																																																																																																																																																																																																																																																																																																																																																																																																																																																																																																																																																																																																																																																																																																																																																																								
		40	300	300	300	300	300	300	300	300	300	300	300	300	300																																																																																																																																																																																																																																																																																																																																																																																																																																																																																																																																																																																																																																																																																																																																																																																																																																																																																																								
		50	300	300	300	300	300	300	300	300	300	300	300	300	300																																																																																																																																																																																																																																																																																																																																																																																																																																																																																																																																																																																																																																																																																																																																																																																																																																																																																																								
11.00R16	S	30	300	300	300	300	300	300	300	300	300	300	300	300	300																																																																																																																																																																																																																																																																																																																																																																																																																																																																																																																																																																																																																																																																																																																																																																																																																																																																																																								
		40	300	300	300	300	300	300	300	300	300	300	300	300																																																																																																																																																																																																																																																																																																																																																																																																																																																																																																																																																																																																																																																																																																																																																																																																																																																																																																									
		50	300	300	300	300	300	300	300	300	300	300	300	300																																																																																																																																																																																																																																																																																																																																																																																																																																																																																																																																																																																																																																																																																																																																																																																																																																																																																																									
12.00R16	S	30	300	300	300	300	300	300	300	300	300	300	300	300	300																																																																																																																																																																																																																																																																																																																																																																																																																																																																																																																																																																																																																																																																																																																																																																																																																																																																																																								
		40	300	300	300	300	300	300	300	300	300	300	300	300																																																																																																																																																																																																																																																																																																																																																																																																																																																																																																																																																																																																																																																																																																																																																																																																																																																																																																									
		50	300	300	300	300	300	300	300	300	300	300	300	300																																																																																																																																																																																																																																																																																																																																																																																																																																																																																																																																																																																																																																																																																																																																																																																																																																																																																																									
12.00R18	S	30	300	300	300	300	300	300	300	300	300	300	300	300	300																																																																																																																																																																																																																																																																																																																																																																																																																																																																																																																																																																																																																																																																																																																																																																																																																																																																																																								
		40	300	300	300	300	300	300	300	300	300	300	300	300																																																																																																																																																																																																																																																																																																																																																																																																																																																																																																																																																																																																																																																																																																																																																																																																																																																																																																									
		50	300	300	300	300	300	300	300	300	300	300	300	300																																																																																																																																																																																																																																																																																																																																																																																																																																																																																																																																																																																																																																																																																																																																																																																																																																																																																																									
12.00R20	S	30	300	300	300	300	300	300	300	300	300	300	300	300	300																																																																																																																																																																																																																																																																																																																																																																																																																																																																																																																																																																																																																																																																																																																																																																																																																																																																																																								
		40	300	300	300	300	300	300	300	300	300	300	300	300																																																																																																																																																																																																																																																																																																																																																																																																																																																																																																																																																																																																																																																																																																																																																																																																																																																																																																									
		50	300	300	300	300	300	300	300	300	300	300	300	300																																																																																																																																																																																																																																																																																																																																																																																																																																																																																																																																																																																																																																																																																																																																																																																																																																																																																																									
12.00R22	S	30	300	300	300	300	300	300	300	300	300	300	300	300	300																																																																																																																																																																																																																																																																																																																																																																																																																																																																																																																																																																																																																																																																																																																																																																																																																																																																																																								
		40	300	300	300	300	300	300	300	300	300	300	300	300																																																																																																																																																																																																																																																																																																																																																																																																																																																																																																																																																																																																																																																																																																																																																																																																																																																																																																									
		50	300	300	300	300	300	300	300	300	300	300	300	300																																																																																																																																																																																																																																																																																																																																																																																																																																																																																																																																																																																																																																																																																																																																																																																																																																																																																																									
12.00R24	S	30	300	300	300	300	300	300	300	300	300	300	300	300	300																																																																																																																																																																																																																																																																																																																																																																																																																																																																																																																																																																																																																																																																																																																																																																																																																																																																																																								
		40	300	300	300	300	300	300	300	300	300	300	300	300																																																																																																																																																																																																																																																																																																																																																																																																																																																																																																																																																																																																																																																																																																																																																																																																																																																																																																									
		50	300	300	300	300	300	300	300	300	300	300	300	300																																																																																																																																																																																																																																																																																																																																																																																																																																																																																																																																																																																																																																																																																																																																																																																																																																																																																																									
12.00R26	S	30	300	300	300	300	300	300	300	300	300	300	300	300	300																																																																																																																																																																																																																																																																																																																																																																																																																																																																																																																																																																																																																																																																																																																																																																																																																																																																																																								
		40	300	300	300	300	300	300	300	300	300	300	300	300																																																																																																																																																																																																																																																																																																																																																																																																																																																																																																																																																																																																																																																																																																																																																																																																																																																																																																									
		50	300	300	300	300	300	300	300	300	300	300	300	300																																																																																																																																																																																																																																																																																																																																																																																																																																																																																																																																																																																																																																																																																																																																																																																																																																																																																																									
12.00R28	S	30	300	300	300	300	300	300	300	300	300	300	300	300	300																																																																																																																																																																																																																																																																																																																																																																																																																																																																																																																																																																																																																																																																																																																																																																																																																																																																																																								
		40	300	300	300	300	300	300	300	300	300	300	300	300																																																																																																																																																																																																																																																																																																																																																																																																																																																																																																																																																																																																																																																																																																																																																																																																																																																																																																									
		50	300	300	300	300	300	300	300	300	300	300	300	300																																																																																																																																																																																																																																																																																																																																																																																																																																																																																																																																																																																																																																																																																																																																																																																																																																																																																																									
12.00R30	S	30	300	300	300	300	300	300	300	300	300	300	300	300	300																																																																																																																																																																																																																																																																																																																																																																																																																																																																																																																																																																																																																																																																																																																																																																																																																																																																																																								
		40	300	300	300	300	300	300	300	300	300	300	300	300																																																																																																																																																																																																																																																																																																																																																																																																																																																																																																																																																																																																																																																																																																																																																																																																																																																																																																									
		50	300	300	300	300	300	300	300	300	300	300	300	300																																																																																																																																																																																																																																																																																																																																																																																																																																																																																																																																																																																																																																																																																																																																																																																																																																																																																																									
12.00R32	S	30	300	300	300	300	300	300	300	300	300	300	300	300	300																																																																																																																																																																																																																																																																																																																																																																																																																																																																																																																																																																																																																																																																																																																																																																																																																																																																																																								
		40	300	300	300	300	300	300	300	300	300	300	300	300																																																																																																																																																																																																																																																																																																																																																																																																																																																																																																																																																																																																																																																																																																																																																																																																																																																																																																									
		50	300	300	300	300	300	300	300	300	300	300	300	300																																																																																																																																																																																																																																																																																																																																																																																																																																																																																																																																																																																																																																																																																																																																																																																																																																																																																																									
12.00R34	S	30	300	300	300	300	300	300	300	300	300	300	300	300	300																																																																																																																																																																																																																																																																																																																																																																																																																																																																																																																																																																																																																																																																																																																																																																																																																																																																																																								
		40	300	300	300	300	300	300	300	300	300	300	300	300																																																																																																																																																																																																																																																																																																																																																																																																																																																																																																																																																																																																																																																																																																																																																																																																																																																																																																									
		50	300	300	300	300	300	300	300	300	300	300	300	300																																																																																																																																																																																																																																																																																																																																																																																																																																																																																																																																																																																																																																																																																																																																																																																																																																																																																																									
12.00R36	S	30	300	300	300	300	300	300	300	300	300	300	300	300	300																																																																																																																																																																																																																																																																																																																																																																																																																																																																																																																																																																																																																																																																																																																																																																																																																																																																																																								
		40	300	300	300	300	300	300	300	300	300	300	300	300																																																																																																																																																																																																																																																																																																																																																																																																																																																																																																																																																																																																																																																																																																																																																																																																																																																																																																									
		50	300	300	300	300	300	300	300	300	300	300	300	300																																																																																																																																																																																																																																																																																																																																																																																																																																																																																																																																																																																																																																																																																																																																																																																																																																																																																																									
12.00R38	S	30	300	300	300	300	300	300	300	300	300	300	300	300	300																																																																																																																																																																																																																																																																																																																																																																																																																																																																																																																																																																																																																																																																																																																																																																																																																																																																																																								
		40	300	300	300	300	300	300	300	300	300	300	300	300																																																																																																																																																																																																																																																																																																																																																																																																																																																																																																																																																																																																																																																																																																																																																																																																																																																																																																									
		50	300	300	300	300	300	300	300	300	300	300	300	300																																																																																																																																																																																																																																																																																																																																																																																																																																																																																																																																																																																																																																																																																																																																																																																																																																																																																																									
12.00R40	S	30	300	300	300	300	300	300	300	300	300	300	300	300	300																																																																																																																																																																																																																																																																																																																																																																																																																																																																																																																																																																																																																																																																																																																																																																																																																																																																																																								
		40	300	300	300	300	300	300	300	300	300	300	300	300																																																																																																																																																																																																																																																																																																																																																																																																																																																																																																																																																																																																																																																																																																																																																																																																																																																																																																									
		50	300	300	300	300	300	300	300	300	300	300	300	300																																																																																																																																																																																																																																																																																																																																																																																																																																																																																																																																																																																																																																																																																																																																																																																																																																																																																																									
12.00R42	S	30	300	300	300	300	300	300	300	300	300	300	300	300	300																																																																																																																																																																																																																																																																																																																																																																																																																																																																																																																																																																																																																																																																																																																																																																																																																																																																																																								
		40	300	300	300	300	300	300	300	300	300	300	300	300																																																																																																																																																																																																																																																																																																																																																																																																																																																																																																																																																																																																																																																																																																																																																																																																																																																																																																									
		50	300	300	300	300	300	300	300	300	300	300	300	300																																																																																																																																																																																																																																																																																																																																																																																																																																																																																																																																																																																																																																																																																																																																																																																																																																																																																																									
12.00R44	S	30	300	300	300	300	300	300	300	300	300	300	300	300	300																																																																																																																																																																																																																																																																																																																																																																																																																																																																																																																																																																																																																																																																																																																																																																																																																																																																																																								
		40	300	300	300	300	300	300	300	300	300	300	300	300																																																																																																																																																																																																																																																																																																																																																																																																																																																																																																																																																																																																																																																																																																																																																																																																																																																																																																									
		50	300	300	300	300	300	300	300	300	300	300	300	300																																																																																																																																																																																																																																																																																																																																																																																																																																																																																																																																																																																																																																																																																																																																																																																																																																																																																																									
12.00R46	S	30	300	300	300	300	300	300	300	300	300	300	300	300	300																																																																																																																																																																																																																																																																																																																																																																																																																																																																																																																																																																																																																																																																																																																																																																																																																																																																																																								
		40	300	300	300	300	300	300	300	300	300	300	300	300																																																																																																																																																																																																																																																																																																																																																																																																																																																																																																																																																																																																																																																																																																																																																																																																																																																																																																									
		50	300	300	300	300	300	300	300	300	300	300	300	300																																																																																																																																																																																																																																																																																																																																																																																																																																																																																																																																																																																																																																																																																																																																																																																																																																																																																																									
12.00R48	S	30	300	300	300	300	300	300	300	300	300	300	300	300	300																																																																																																																																																																																																																																																																																																																																																																																																																																																																																																																																																																																																																																																																																																																																																																																																																																																																																																								
		40	300	300	300	300	300	300	300	300	300	300	300	300																																																																																																																																																																																																																																																																																																																																																																																																																																																																																																																																																																																																																																																																																																																																																																																																																																																																																																									
		50	300	300	300	300	300	300	300	300	300	300	300	300																																																																																																																																																																																																																																																																																																																																																																																																																																																																																																																																																																																																																																																																																																																																																																																																																																																																																																									
12.00R50	S	30	300	300	300	300	300	300	300	300	300	300	300	300	300																																																																																																																																																																																																																																																																																																																																																																																																																																																																																																																																																																																																																																																																																																																																																																																																																																																																																																								
		40	300	300	300	300	300	300	300	300	300	300	300	300																																																																																																																																																																																																																																																																																																																																																																																																																																																																																																																																																																																																																																																																																																																																																																																																																																																																																																									
		50	300	300	300	300	300	300	300	300	300	300	300	300																																																																																																																																																																																																																																																																																																																																																																																																																																																																																																																																																																																																																																																																																																																																																																																																																																																																																																									

FOR RIM AND WHEEL LOAD INFORMATION, SEE IMPORTANT NOTES ON PAGES 168-172.
Page 80 | 200 Firestone

LOAD AND INFLATION TABLES

After the product pages, load and Inflation tables are available. The tire sizes are listed vertically on the left side of each table (1), and the PSI or kPa extends from left to right at the top of each table (2). Using the table summary at the start of the section, select the appropriate description for the size of tire (tables are broken down based on radial or bias, AD2 IF/VF or standard, farm or flotation, and so on). Then – within the appropriate table - locate the tire size in the left-hand column. Next, if applicable based on the equipment setup (singles, duals, triples), find the applicable load per tire and locate the PSI or kPa at the top of the column. The star rating symbols identify the maximum inflation pressure for a tire. For example, one star (★) = 18 PSI; two star (★★) = 24 PSI; 3 star (★★★) = 30 PSI, and so on.

GENERAL TIRE INFORMATION

After the section on load and inflation tables is a section identified as 'General Tire Information'. This section includes helpful tools such as International Load Index Numbers, Tire Comparison Charts, RCI Index Chart, Approved Rim Contours, Hydro-inflation Tables, Safety Information, and Measuring and

Correcting Lead / Lag and Power Hop (MFWD & 4WD).

WARRANTIES

The final section details the various warranties and policies available through Firestone Ag, including the nine-year warranty on premium radial tires. Details on stubble damage and field hazard policies are also included.

TIRES BY SIZE

TIRE SIZE		PATTERN NAME	MATERIAL NUMBER	BRAND	PAGE
4.50-10		FARM SERVICE RIB — F-2	344648	BRIDGESTONE	68
20X8.00-10	D	TURF & FIELD — G-2	381755	FIRESTONE	87
5-12		AG TRACTOR — G-1	382333	REGENCY	70
6-12		FARM SERVICE DIA — R-3	010052	BRIDGESTONE	68
6-12	D	FARM SERVICE DIA — R-3	344699	BRIDGESTONE	79
6-12		AG TRACTOR — G-1	382367	REGENCY	70
23X8.50-12	D	TURF & FIELD — G-2	381789	FIRESTONE	87
23X10.50-12	D	TURF & FIELD — G-2	381738	FIRESTONE	87
24X8.50-12	D	TURF & FIELD — G-2	381721	FIRESTONE	87
24X8.50-12	D	TURF & FIELD — G-2	381721	FIRESTONE	87
26X12.00-12	D	FLOTATION 23° — G-1	381772	FIRESTONE	80
5-14		FARM SERVICE LUG-M — R-1	344443	BRIDGESTONE	67
6-14		FARM SERVICE DIA — R-3	010054	BRIDGESTONE	68
6-14		AG TRACTOR — G-1	382401	REGENCY	70
6-14	D	FARM SERVICE DIA — R-3	344362	BRIDGESTONE	79
7-14		AG TRACTOR — G-1	382384	REGENCY	70
8.5L-14		FARM IMPLEMENT — I-1	339148	FIRESTONE	58
9.5L-14		FARM IMPLEMENT — I-1	358940	FIRESTONE	58
9.5L-14		FARM IMPLEMENT — I-1	008539	FIRESTONE	58
9.5L-14		AG IMPLEMENT — I-1	378763	REGENCY	69
11L-14		FARM IMPLEMENT — I-1	008530	FIRESTONE	58
11L-14	D	FARM IMPLEMENT — F-1	350028	FIRESTONE	79
200/85D14	D	SUPER ALL TRACTION II 23° — R-1	365571	FIRESTONE	85
215/65D14	D	SUPER ALL TRACTION DUPLEX — NHS	365588	FIRESTONE	86
25X8.50-14	D	TURF & FIELD — G-2	381687	FIRESTONE	87
25X8.50-14	D	TURF & FIELD — G-2	381704	FIRESTONE	87
5.00-15		POWER IMPLEMENT — I-3	310069	FIRESTONE	63
5.00-15	D	GUIDE GRIP 3-RIB — F-2	375278	FIRESTONE	81
5.00-15	D	RIB IMPLEMENT — I-1	375346	FIRESTONE	85
5.90-15		FARM IMPLEMENT — I-1	339288	FIRESTONE	58
5.90-15		FARM IMPLEMENT — I-1	362034	FIRESTONE	58
6.70-15		FARM IMPLEMENT — I-1	375652	FIRESTONE	58
6.70-15	D	FARM IMPLEMENT — F-1	339296	FIRESTONE	79
7.5L-15		GUIDE GRIP 3-RIB — F-2	374666	FIRESTONE	56
7.60-15		FARM IMPLEMENT — I-1	339369	FIRESTONE	58
7.60-15		FARM IMPLEMENT — I-1	008538	FIRESTONE	58
7.60-15		DUO RIB PLANTER — I-1	325864	FIRESTONE	61
7.60-15		POWER IMPLEMENT — I-3	340529	FIRESTONE	63

TIRES BY SIZE

TIRE SIZE		PATTERN NAME	MATERIAL NUMBER	BRAND	PAGE
7.60-15		POWER IMPLEMENT — I-3	008551	FIRESTONE	63
7.60-15		AG IMPLEMENT — I-1	378338	REGENCY	69
8.0/75-15	D	RANCHER — G-1	361941	FIRESTONE	84
9.5L-15		CHAMPION GUIDE GRIP 4-RIB — F-2	375227	FIRESTONE	54
9.5L-15		CHAMPION GUIDE GRIP 4-RIB — F-2	008523	FIRESTONE	54
9.5L-15		FARM IMPLEMENT — I-1	339377	FIRESTONE	58
9.5L-15		FARM IMPLEMENT — I-1	008540	FIRESTONE	58
9.5L-15		FARM IMPLEMENT — I-1	355860	FIRESTONE	58
9.5L-15		AG IMPLEMENT — I-1	378287	REGENCY	69
9.5L-15FI		HIGHWAY SPECIAL — I-1	374598	FIRESTONE	57
9.5L-15FI		HIGHWAY SPECIAL — I-1	013528	FIRESTONE	57
10.00-15		FARM TIRE — I-1	329614	FIRESTONE	59
10.00-15		FARM TIRE — I-1	008529	FIRESTONE	59
11L-15		CHAMPION GUIDE GRIP 4-RIB — F-2	376570	FIRESTONE	54
11L-15		CHAMPION GUIDE GRIP 4-RIB — F-2	008521	FIRESTONE	54
11L-15		CHAMPION GUIDE GRIP 3-RIB — F-2	375142	FIRESTONE	55
11L-15		INDUSTRIAL SPECIAL — F-3	316024	FIRESTONE	56
11L-15		INDUSTRIAL SPECIAL — F-3	008547	FIRESTONE	56
11L-15		INDUSTRIAL SPECIAL — F-3	326011	FIRESTONE	56
11L-15		FARM IMPLEMENT — I-1	339547	FIRESTONE	58
11L-15		FARM IMPLEMENT — I-1	008531	FIRESTONE	58
11L-15		FARM IMPLEMENT — I-1	339482	FIRESTONE	58
11L-15		AG IMPLEMENT — I-1	378304	REGENCY	69
11L-15FI		HIGHWAY SPECIAL — I-1	374581	FIRESTONE	57
12.5L-15		FARM IMPLEMENT — I-1	339598	FIRESTONE	58
12.5L-15		FARM IMPLEMENT — I-1	354538	FIRESTONE	58
12.5L-15		FARM IMPLEMENT — I-1	378457	FIRESTONE	58
12.5L-15		POWER IMPLEMENT — I-3	008548	FIRESTONE	63
12.5L-15	D	POWER IMPLEMENT — I-3	340561	FIRESTONE	82
12.5L-15		AG IMPLEMENT — I-1	378321	REGENCY	69
12.5L-15FI		HIGHWAY SPECIAL — I-1	374564	FIRESTONE	57
27X8.50-15		SUPER TRACTION LOADER — I-3	350672	FIRESTONE	64
27X8.50-15		FARM IMPLEMENT — HF-1	379460	FIRESTONE	65
27X8.50-15		FARM IMPLEMENT — HF-1	008534	FIRESTONE	65
27X8.50-15	D	TURF & FIELD — G-2	381670	FIRESTONE	87
27X9.50-15		FARM IMPLEMENT — I-1	008536	FIRESTONE	58
27X9.50-15	D	FARM IMPLEMENT — F-1	357804	FIRESTONE	79
29X12.00-15		TURF & FIELD — HF-2	359785	FIRESTONE	66

TIRES BY SIZE

TIRE SIZE		PATTERN NAME	MATERIAL NUMBER	BRAND	PAGE
31X13.50-15		RIB IMPLEMENT — I-1	008554	FIRESTONE	60
31X13.50-15		RIB IMPLEMENT — I-1	358622	FIRESTONE	60
31X13.50-15	D	RIB IMPLEMENT — I-1	008554	FIRESTONE	85
31X13.50-15		TURF & FIELD — HF-2	354856	FIRESTONE	66
31X13.50-15		TURF & FIELD — HF-2	362190	FIRESTONE	66
31X15.50-15		FLOTATION 23° — HF-3	314420	FIRESTONE	65
IF200/90R15		DESTINATION FARM — I-1	008689	FIRESTONE	52
IF210/75R15		DESTINATION FARM — I-1	005514	FIRESTONE	52
IF240/80R15		DESTINATION FARM — I-1	000543	FIRESTONE	52
IF265/85R15		DESTINATION FARM — I-1	001585	FIRESTONE	52
IF26585R15	D	DESTINATION FARM — I-1	000544	FIRESTONE	78
IF280/70R15		DESTINATION FARM — I-1	004844	FIRESTONE	52
IF280/70R15	D	DESTINATION FARM — I-1	000410	FIRESTONE	78
IF320/65R15		DESTINATION FARM — I-1	007118	FIRESTONE	52
IF320/65R15		DESTINATION TURF — I-2	007119	FIRESTONE	53
IF320/70R15		DESTINATION FARM — I-1	003166	FIRESTONE	52
IF320/70R15		DESTINATION TURF — I-2	006264	FIRESTONE	53
6.00-16		CHAMPION GUIDE GRIP 3-RIB — F-2	374700	FIRESTONE	55
6.00-16		FARM IMPLEMENT — I-1	339199	FIRESTONE	58
6.00-16		AG FRONT 3-RIB — F-2	378253	REGENCY	70
6.00-16		AG TRACTOR — G-1	382350	REGENCY	70
6.50-16		CHAMPION GUIDE GRIP 3-RIB — F-2	374683	FIRESTONE	55
7-16		AG TRACTOR — G-1	382418	REGENCY	70
7.50-16		CHAMPION GUIDE GRIP 4-RIB — F-2	374717	FIRESTONE	54
7.50-16		CHAMPION GUIDE GRIP 3-RIB — F-2	374751	FIRESTONE	55
8-16		FARM SERVICE LUG-M — R-1	344494	BRIDGESTONE	67
8-16		AG TRACTOR — G-1	382435	REGENCY	70
9.5-16		SUPER ALL TRACTION II 23° — R-1	376808	FIRESTONE	43
9.5-16		TURF & FIELD — R-3	351776	FIRESTONE	48
10.00-16		CHAMPION GUIDE GRIP 4-RIB — F-2	008519	FIRESTONE	54
10.00-16		CHAMPION GUIDE GRIP 4-RIB — F-2	008524	FIRESTONE	54
10.00-16		CHAMPION GUIDE GRIP 3-RIB — F-2	008512	FIRESTONE	55
10.00-16		CHAMPION GUIDE GRIP 3-RIB — F-2	357847	FIRESTONE	55
10.00-16		CHAMPION GUIDE GRIP 3-RIB — F-2	008616	FIRESTONE	55
10.00-16		AG FRONT 3-RIB — F-2	378032	REGENCY	70
10.00-16	D	CHAMPION GUIDE GRIP 4-RIB — F-2	339865	FIRESTONE	77
10.00-16	D	CHAMPION GUIDE GRIP 4-RIB — F-2	357898	FIRESTONE	77
10.00-16	D	CHAMPION GUIDE GRIP 4-RIB — F-2	368750	FIRESTONE	77

TIRES BY SIZE

TIRE SIZE		PATTERN NAME	MATERIAL NUMBER	BRAND	PAGE
10.00-16	D	CHAMPION GUIDE GRIP 3-RIB — F-2	350877	FIRESTONE	77
11.00-16		CHAMPION GUIDE GRIP 4-RIB — F-2	339873	FIRESTONE	54
11.00-16		CHAMPION GUIDE GRIP 4-RIB — F-2	008520	FIRESTONE	54
11.00-16		CHAMPION GUIDE GRIP 4-RIB — F-2	342602	FIRESTONE	54
11.00-16		CHAMPION GUIDE GRIP 4-RIB — F-2	008525	FIRESTONE	54
11.00-16		CHAMPION GUIDE GRIP 3-RIB — F-2	008513	FIRESTONE	55
11.00-16		CHAMPION GUIDE GRIP 3-RIB — F-2	357855	FIRESTONE	55
11.00-16		CHAMPION GUIDE GRIP 3-RIB — F-2	008517	FIRESTONE	55
11.00-16		AG FRONT 4-RIB — F-2	378270	REGENCY	69
11.00-16	D	CHAMPION GUIDE GRIP 4-RIB — F-2	357901	FIRESTONE	77
11.00-16	D	CHAMPION GUIDE GRIP 3-RIB — F-2	350885	FIRESTONE	77
11L-16		FARM IMPLEMENT — I-1	008532	FIRESTONE	58
11L-16	D	FARM IMPLEMENT — F-1	359831	FIRESTONE	79
12.4-16		TRACTION FIELD & ROAD — R-1	345202	FIRESTONE	44
12.5L-16		FARM IMPLEMENT — I-1	356840	FIRESTONE	58
12.5L-16	D	FARM IMPLEMENT — F-1	339474	FIRESTONE	79
12.5L-16	D	FARM IMPLEMENT — F-1	339490	FIRESTONE	79
13.6-16		TURF & FIELD — R-3	345210	FIRESTONE	48
13.50-16.1		ALL NON-SKID (ANS) FARM — I-2	011681	FIRESTONE	62
13.50-16.1	D	ALL NON-SKID (ANS) FARM — I-2	325015	FIRESTONE	77
13.50-16.1	D	POWER IMPLEMENT — I-3	342688	FIRESTONE	82
13.50-16.1		POWER IMPLEMENT — I-3	008549	FIRESTONE	63
14L-16.1		CHAMPION GUIDE GRIP 4-RIB — F-2	359432	FIRESTONE	54
14L-16.1		CHAMPION GUIDE GRIP 3-RIB — F-2	322687	FIRESTONE	55
14L-16.1		FARM IMPLEMENT — I-1	354686	FIRESTONE	58
14L-16.1		FARM IMPLEMENT — I-1	008533	FIRESTONE	58
14L-16.1		FARM IMPLEMENT — I-1	376876	FIRESTONE	58
14L-16.1	D	CHAMPION GUIDE GRIP 4-RIB — F-2	365537	FIRESTONE	77
14L-16.1	D	CHAMPION GUIDE GRIP 3-RIB — F-2	354449	FIRESTONE	77
14L-16.1	D	FARM IMPLEMENT — F-1	365520	FIRESTONE	79
16.5L-16.1		CHAMPION GUIDE GRIP 4-RIB — F-2	339938	FIRESTONE	54
16.5L-16.1		FARM IMPLEMENT — I-1	339636	FIRESTONE	58
16.5L-16.1		FARM IMPLEMENT — I-1	342483	FIRESTONE	58
16.5L-16.1		ALL NON-SKID (ANS) FARM — I-2	008506	FIRESTONE	62
16.5L-16.1		TURF & FIELD — I-3	317365	FIRESTONE	62

TIRES BY SIZE

TIRE SIZE		PATTERN NAME	MATERIAL NUMBER	BRAND	PAGE
16.5L-16.1		POWER IMPLEMENT — I-3	008550	FIRESTONE	63
16.5L-16.1		POWER IMPLEMENT — I-3	342467	FIRESTONE	63
16.5L-16.1	D	ALL NON-SKID (ANS) FARM — I-2	310514	FIRESTONE	77
16.5L-16.1	D	POWER IMPLEMENT — I-3	340618	FIRESTONE	82
18.4-16.1		TRACTION FIELD & ROAD — R-1	359564	FIRESTONE	44
19L-16.1		FARM TIRE — I-1	359777	FIRESTONE	59
21.5L-16.1		TURF & FIELD — R-3	012720	FIRESTONE	48
21.5L-16.1		TURF & FIELD — R-3	008596	FIRESTONE	48
21.5L-16.1		FARM TIRE — I-1	318507	FIRESTONE	59
21.5L-16.1		FARM TIRE — I-1	008575	FIRESTONE	59
21.5L-16.1		TURF & FIELD — I-3	312770	FIRESTONE	62
21.5L-16.1		TURF & FIELD — I-3	355887	FIRESTONE	62
21.5L-16.1		POWER IMPLEMENT — I-3	359408	FIRESTONE	63
21.5L-16.1		POWER IMPLEMENT — I-3	359416	FIRESTONE	63
21.5L-16.1	D	FARM TIRE — I-1	325848	FIRESTONE	79
250/85D16.5	D	SUPER ALL TRACTION II 23° — R-1	365401	FIRESTONE	85
265/55D16.5	D	FLOTATION SUPER ALL TERRAIN — HF-1	365350	FIRESTONE	80
320/55D16.5	D	FLOTATION SUPER ALL TERRAIN — HF-1	365384	FIRESTONE	80
395/55D16.5NHS		DURAFORCE ND — NHS	360503	FIRESTONE	51
36X16B17.5		RIB DUPLEX FARM — I-1	318523	FIRESTONE	61
36X16-17.5		RIB DUPLEX FARM — I-1	361968	FIRESTONE	61
355/70D17.5NHS		DURAFORCE ND — NHS	361666	FIRESTONE	51
8-18		FARM SERVICE LUG-M — R-1	355925	BRIDGESTONE	67
280/70R18		RADIAL 4000 — R-1W	365027	FIRESTONE	35
380/70D19.5	D	FLOTATION SUPER ALL TERRAIN — HF-1	365639	FIRESTONE	80
385/65D19.5NHS		DURAFORCE ND — NHS	361682	FIRESTONE	51
40X19B19.5		NON-DIRECTIONAL DUPLEX FARM — I-3	323004	FIRESTONE	63
VF245/70R19.5		DESTINATION FARM — I-1	001581	FIRESTONE	52
VF245/70R19.5	D	DESTINATION FARM — I-1	000555	FIRESTONE	78
VF265/70R19.5		DESTINATION FARM — I-1	000896	FIRESTONE	52
VF285/70R19.5		DESTINATION FARM — I-1	000895	FIRESTONE	52
7.50-20		FARM IMPLEMENT — I-1	339326	FIRESTONE	58
7.50-20		FARM IMPLEMENT — I-1	008537	FIRESTONE	58
7.50-20		DUO RIB PLANTER — I-1	313424	FIRESTONE	61
7.50-20	D	CHAMPION GUIDE GRIP 3-RIB — F-2	352594	FIRESTONE	77
48X25.00-20		FLOTATION 23° (CENTER RIB) — HF-2	328057	FIRESTONE	75
48X25.00-20		FLOTATION FREE ROLLING — HF-2	360422	FIRESTONE	75
48X31.00-20		FLOTATION 23° (CENTER RIB) — HF-2	361984	FIRESTONE	75

TIRES BY SIZE

TIRE SIZE		PATTERN NAME	MATERIAL NUMBER	BRAND	PAGE
48X31.00-20		FLOTATION FREE ROLLING — HF-2	360430	FIRESTONE	75
360/70R20		RADIAL 4000 — R-1W	008545	FIRESTONE	35
360/70R20	D	RADIAL 4000 — R-1W	365843	FIRESTONE	82
8.3-22		FARM SERVICE LUG-18 — R-1	378695	BRIDGESTONE	67
9.5-22		FARM SERVICE LUG-M — R-1	363752	BRIDGESTONE	67
600/55-22.5		FLOTATION IMPLEMENT — I-3	364653	FIRESTONE	64
700/50-22.5		FLOTATION IMPLEMENT — I-3	359003	FIRESTONE	64
VF255/70R22.5	D	DESTINATION FARM — I-1	000898	FIRESTONE	78
VF295/75R22.5		DESTINATION FARM — I-1	001583	FIRESTONE	52
VF295/75R22.5	D	DESTINATION FARM — I-1	000554	FIRESTONE	78
VF385/65R22.5		DESTINATION FARM — I-1	000899	FIRESTONE	52
VF385/65R22.5	D	DESTINATION FARM — I-1	000582	FIRESTONE	78
VF445/50R22.5		DESTINATION TURF — I-2	007469	FIRESTONE	53
445/65D22.5NHS		DURAFORCE ND — NHS	361720	FIRESTONE	51
VF445/65R22.5		DESTINATION FARM — I-1	001584	FIRESTONE	52
VF445/65R22.5	D	DESTINATION FARM — I-1	000583	FIRESTONE	78
8.3-24		ALL NON-SKID TRACTOR — R-3	351733	FIRESTONE	49
8.3-24	D	TRACTION FIELD & ROAD — R-1	351644	FIRESTONE	86
9.00-24		RIB IMPLEMENT — I-1	008555	FIRESTONE	60
9.00-24		RIB IMPLEMENT — I-1	356212	FIRESTONE	60
9.5-24		SUPER ALL TRACTION II 23° — R-1	008564	FIRESTONE	43
9.5-24	D	ALL NON-SKID TRACTOR — R-3	306096	FIRESTONE	77
9.5-24	D	SUPER ALL TRACTION II 23° — R-1	371351	FIRESTONE	85
11.2-24		SUPER ALL TRACTION II 23° — R-1	365180	FIRESTONE	43
11.2-24		TRACTION FIELD & ROAD — R-1	008565	FIRESTONE	44
11.2-24		IRRIGATION SPECIAL — R-1	321893	FIRESTONE	46
11.2-24		FARM SERVICE DIA — R-3	344869	BRIDGESTONE	68
11.2-24	D	IRRIGATION SPECIAL — R-1	349984	FIRESTONE	81
11.2-24	D	SUPER ALL TRACTION II 23° — R-1	365163	FIRESTONE	85
11.2-24	D	TRACTION FIELD & ROAD — R-1	351725	FIRESTONE	86
11.25-24		RIB IMPLEMENT — I-1	324221	FIRESTONE	60
11.25-24		RIB IMPLEMENT — I-1	355534	FIRESTONE	60
12.4-24		SUPER ALL TRACTION II 23° — R-1	365299	FIRESTONE	43
12.4-24		SUPER ALL TRACTION II 23° — R-1	008556	FIRESTONE	43
12.4-24		SUPER ALL TRACTION II 23° — R-1	372541	FIRESTONE	43
12.4-24		TRACTION FIELD & ROAD — R-1	357987	FIRESTONE	44

TIRES BY SIZE

TIRE SIZE		PATTERN NAME	MATERIAL NUMBER	BRAND	PAGE
13.6-24		SUPER ALL TRACTION II 23° — R-1	372575	FIRESTONE	43
14.9-24		SUPER ALL TRACTION II 23° — R-1	365061	FIRESTONE	43
14.9-24		SUPER ALL TRACTION II 23° — R-1	008559	FIRESTONE	43
14.9-24		SUPER ALL TRACTION II 23° — R-1	373238	FIRESTONE	43
14.9-24		SUPER ALL TRACTION II 23° — R-1	008560	FIRESTONE	43
14.9-24		TRACTION FIELD & ROAD — R-1	345334	FIRESTONE	44
14.9-24		TRACTION FIELD & ROAD — R-1	008568	FIRESTONE	44
14.9-24		IRRIGATION SPECIAL — R-1	322377	FIRESTONE	46
14.9-24		IRRIGATION SPECIAL — R-1	342459	FIRESTONE	46
14.9-24		IRRIGATION SPECIAL — R-1	000912	FIRESTONE	46
14.9-24		CHAMPION SPADE GRIP — R-2	359610	FIRESTONE	47
14.9-24		ALL NON-SKID TRACTOR — R-3	351709	FIRESTONE	49
14.9-24		ALL NON-SKID TRACTOR — R-3	008508	FIRESTONE	49
14.9-24		ALL TRACTION UTILITY — R-4	358584	FIRESTONE	50
16.9-24		TRACTION FIELD & ROAD — R-1	359505	FIRESTONE	44
16.9-24		ALL NON-SKID TRACTOR — R-3	008510	FIRESTONE	49
16.9-24		ALL NON-SKID TRACTOR — R-3	358789	FIRESTONE	49
16.9-24		ALL NON-SKID TRACTOR — R-3	011877	FIRESTONE	49
16.9-24		ALL TRACTION UTILITY — R-4	309281	FIRESTONE	50
17.5L-24		ALL TRACTION UTILITY — R-4	315486	FIRESTONE	50
19.5L-24		TURF & FIELD — R-3	356190	FIRESTONE	48
280/85R24		PERFORMER 85 — R-1W	000565	FIRESTONE	31
320/85R24		PERFORMER 85 — R-1W	000566	FIRESTONE	31
320/85R24	D	RADIAL ALL TRACTION DT — R-1W	362681	FIRESTONE	83
340/85R24		PERFORMER 85 — R-1W	000567	FIRESTONE	31
340/85R24	D	RADIAL ALL TRACTION DT — R-1W	362698	FIRESTONE	83
380/70R24		PERFORMER 70 — R-1W	379341	FIRESTONE	32
380/85D24		CHAMPION HYDRO ND — R-1	008526	FIRESTONE	46
380/85D24	D	CHAMPION HYDRO ND — R-1	373765	FIRESTONE	78
380/85R24		RADIAL ALL TRACTION DT — R-1W	362715	FIRESTONE	27
380/85R24		PERFORMER 85 — R-1W	000549	FIRESTONE	31
380/85R24		PERFORMER EVO — R-1W	003167	FIRESTONE	34
400/70R24		RADIAL 8000 UTILITY — R-1W	009314	FIRESTONE	30
420/70-24		ALL TRACTION UTILITY — R-4	351040	FIRESTONE	50
420/70-24		ALL TRACTION UTILITY — R-4	008511	FIRESTONE	50
420/70R24		PERFORMER 70 — R-1W	379188	FIRESTONE	32

TIRES BY SIZE

TIRE SIZE		PATTERN NAME	MATERIAL NUMBER	BRAND	PAGE
420/85R24		PERFORMER 85 — R-1W	000599	FIRESTONE	31
420/85R26		RADIAL ALL TRACTION FWD — R-1	340405	FIRESTONE	37
460/60D24	D	FLOTATION SUPER ALL TERRAIN — HF-1	365418	FIRESTONE	80
480/70R24		PERFORMER 70 — R-1W	381551	FIRESTONE	32
480/85R24		RADIAL 9000 — R-1W	365673	FIRESTONE	29
480/80R34		RADIAL 8000 UTILITY — R-1W	002106	FIRESTONE	30
540/65R24	D	RADIAL 9000 — R-1W	359165	FIRESTONE	82
54X37.00-25		FLOTATION 23° DEEP TREAD LOGGER—HF-3	352063	FIRESTONE	72
54X37.00-25		FLOTATION 23° DEEP TREAD — HF-3	352055	FIRESTONE	76
54X37.00B25		FLOTATION 23° DEEP TREAD LOGGER—HF-3	373102	FIRESTONE	72
66X43.00-25		FLOTATION 23° — HF-3	375465	FIRESTONE	65
66X43.00-25		FLOTATION 23° DEEP TREAD LOGGER—HF-3	354392	FIRESTONE	72
66X43.00-25		FLOTATION 23° EXTRA-DEEP TREAD LOGGER — HF-4	006281	FIRESTONE	72
66X43.00-25		FLOTATION 23° DEEP TREAD — HF-3	340693	FIRESTONE	76
66X43.00-25		FLOTATION 23° DEEP TREAD — HF-3	358312	FIRESTONE	76
66X43.00-25	D	FLOTATION 23° EXTRA-DEEP TREAD LOGGER — HF-3	354325	FIRESTONE	80
66X44.00-25		FLOTATION ALL TERRAIN — HF-1	371674	FIRESTONE	74
67X34.00-25		FLOTATION 23° DEEP TREAD (WTP) LOGGER —HF-4	354902	FIRESTONE	73
67X34.00B25		FLOTATION 23° DEEP TREAD (WTP) LOGGER —HF-4	006276	FIRESTONE	73
14.9-26		TRACTION FIELD & ROAD — R-1	008570	FIRESTONE	44
14.9-26	D	SUPER ALL TRACTION FWD — R-1	343897	FIRESTONE	86
14.9-26	D	TRACTION FIELD & ROAD — R-1	345288	FIRESTONE	86
16.9-26		TRACTION FIELD & ROAD — R-1	008572	FIRESTONE	44
16.9-26	D	CHAMPION SPADE GRIP — R-2	326712	FIRESTONE	78
16.9-26	D	SUPER ALL TRACTION FWD — R-1	343900	FIRESTONE	86
16.9-26	D	TRACTION FIELD & ROAD — R-1	355119	FIRESTONE	86
18.4-26		SUPER ALL TRACTION FWD — R-1	343846	FIRESTONE	42
18.4-26		SUPER ALL TRACTION FWD — R-1	343919	FIRESTONE	42
18.4-26		CHAMPION SPADE GRIP — R-2	326445	FIRESTONE	47
18.4-26		CHAMPION SPADE GRIP — R-2	008598	FIRESTONE	47
18.4-26		ALL NON-SKID TRACTOR — R-3	315958	FIRESTONE	49
18.4-26		ALL NON-SKID TRACTOR — R-3	369753	FIRESTONE	49
18.4-26		FORESTRY SPECIAL WITH CRC (WTP)—LS-2	361771	FIRESTONE	71
18.4-26	D	CHAMPION SPADE GRIP — R-2	358266	FIRESTONE	78
18.4R26		RADIAL ALL TRACTION FWD — R-1	340421	FIRESTONE	37
23.1-26		SUPER ALL TRACTION 23° — R-1	344095	FIRESTONE	41

TIRES BY SIZE

TIRE SIZE		PATTERN NAME	MATERIAL NUMBER	BRAND	PAGE
23.1-26		SUPER ALL TRACTION 23° — R-1	362460	FIRESTONE	41
23.1-26		CHAMPION SPADE GRIP — R-2	362647	FIRESTONE	47
23.1-26		ALL NON-SKID TRACTOR — R-3	345377	FIRESTONE	49
23.1-26		ALL NON-SKID TRACTOR — R-3	323527	FIRESTONE	49
23.1-26	D	FORESTRY SPECIAL WITH CRC — LS2	361798	FIRESTONE	81
23.1B26		FORESTRY SPECIAL WITH CRC (WTP) — LS-2	000407	FIRESTONE	71
23.1B26		FORESTRY SPECIAL WITH CRC (WTP) — LS-2	361801	FIRESTONE	71
23.1R26		RADIAL ALL TRACTION 23° — R-1	379375	FIRESTONE	36
28L-26		SUPER ALL TRACTION 23° — R-1	344060	FIRESTONE	41
28L-26		CHAMPION SPADE GRIP — R-2	379868	FIRESTONE	47
28L-26		ALL NON-SKID TRACTOR — R-3	351008	FIRESTONE	49
28L-26		ALL NON-SKID TRACTOR — R-3	362220	FIRESTONE	49
28L-26		ALL NON-SKID TRACTOR II — R-3	351857	FIRESTONE	50
28L-26		ALL NON-SKID TRACTOR II — R-3	362085	FIRESTONE	50
28L-26	D	CHAMPION SPADE GRIP — R-2	358282	FIRESTONE	78
28L-26	D	FORESTRY SPECIAL WITH CRC — LS2	362494	FIRESTONE	81
28L-26	D	SUPER ALL TRACTION 23° — R-1	351938	FIRESTONE	85
28LB26		FORESTRY SPECIAL WITH CRC (WTP) — LS-2	362511	FIRESTONE	71
28LB26		FORESTRY SPECIAL WITH CRC (WTP) — LS-2	004458	FIRESTONE	71
380/85R26		RADIAL ALL TRACTION FWD — R-1	008852	FIRESTONE	37
420/85R26		MAXI TRACTION — R-1W	008851	FIRESTONE	25
420/85R26		RADIAL ALL TRACTION FWD — R-1	362528	FIRESTONE	37
66X43.00-26		FLOTATION 23° DEEP TREAD LOGGER — HF-3	354422	FIRESTONE	72
66X43.00-26	D	FLOTATION 23° EXTRA-DEEP TREAD LOGGER — HF-3	354333	FIRESTONE	80
67X34.00-26		FLOTATION 23° DEEP TREAD (WTP) LOGGER — HF-4	354899	FIRESTONE	73
VF620/75R26		RADIAL ALL TRACTION DT — R-1W	001603	FIRESTONE	27
VF620/75R26CFO		RADIAL ALL TRACTION DT — R-1W	008684	FIRESTONE	27
750/65R26		MAXI TRACTION — R-1W	006304	FIRESTONE	25
750/65R26		RADIAL ALL TRACTION DT — R-1W	000906	FIRESTONE	27
750/65R26	D	RADIAL ALL TRACTION DT — R-1W	376791	FIRESTONE	83
VF750/65R26		RADIAL ALL TRACTION DT — R-1W	000556	FIRESTONE	27
VF750/65R26CFO		MAXI TRACTION — R-1W	006305	FIRESTONE	25
VF750/65R26CFO		RADIAL CHAMPION SPADE GRIP — R-2	003150	FIRESTONE	39
710/45B26.5		FORESTY EL 700 — HF-1	371623	FIRESTONE	73
11.2-28		FIELD & ROAD — R-1	361623	FIRESTONE	45
11.2-28	D	FIELD & ROAD — R-1	304743	FIRESTONE	79
11.25-28		RIB IMPLEMENT — I-1	326453	FIRESTONE	60

TIRES BY SIZE

TIRE SIZE		PATTERN NAME	MATERIAL NUMBER	BRAND	PAGE
12.4-28		SUPER ALL TRACTION II 23° — R-1	008557	FIRESTONE	43
12.4-28	D	SUPER ALL TRACTION II 23° — R-1	365452	FIRESTONE	85
13.6-28		SUPER ALL TRACTION FWD — R-1	343927	FIRESTONE	42
13.6-28		SUPER ALL TRACTION II 23° — R-1	008558	FIRESTONE	43
13.6-28	D	ALL NON-SKID TRACTOR — R-3	306193	FIRESTONE	77
13.6-28	D	SUPER ALL TRACTION II 23° — R-1	365265	FIRESTONE	85
13.6-28	D	TRACTION FIELD & ROAD — R-1	361917	FIRESTONE	86
14.9-28		SUPER ALL TRACTION II 23° — R-1	365078	FIRESTONE	43
14.9-28		SUPER ALL TRACTION II 23° — R-1	008561	FIRESTONE	43
14.9-28	D	SUPER ALL TRACTION FWD — R-1	343935	FIRESTONE	86
16.9-28		SUPER ALL TRACTION FWD — R-1	343943	FIRESTONE	42
16.9-28		SUPER ALL TRACTION FWD — R-1	008594	FIRESTONE	42
16.9-28		SUPER ALL TRACTION II 23° — R-1	008562	FIRESTONE	43
16.9-28	D	SUPER ALL TRACTION II 23° — R-1	365469	FIRESTONE	85
16.9R28		RADIAL CHAMPION SPADE GRIP — R-2	352527	FIRESTONE	39
18.4-28		TRACTION FIELD & ROAD — R-1	338494	FIRESTONE	44
18.4R28	D	RADIAL CHAMPION SPADE GRIP — R-2	352748	FIRESTONE	84
320/85R28		PERFORMER 85 — R-1W	000588	FIRESTONE	31
340/85R28		PERFORMER EVO — R-1W	006353	FIRESTONE	34
340/85R28		RADIAL ALL TRACTION FWD — R-1	362545	FIRESTONE	37
340/85R28	D	PERFORMER 85 — R-1W	000550	FIRESTONE	81
360/70R28		PERFORMER 70 — R-1W	382120	FIRESTONE	32
380/70R28		PERFORMER 70 — R-1W	000627	FIRESTONE	32
380/85R28		PERFORMER 85 — R-1W	000589	FIRESTONE	31
380/85R28		PERFORMER EVO — R-1W	003152	FIRESTONE	34
380/85R28		RADIAL ALL TRACTION FWD — R-1	362562	FIRESTONE	37
420/70R28		PERFORMER 70 — R-1W	004088	FIRESTONE	32
420/85R28		PERFORMER 85 — R-1W	000600	FIRESTONE	31
420/85R28		PERFORMER EVO — R-1W	007475	FIRESTONE	34
420/85R28		RADIAL ALL TRACTION FWD — R-1	362579	FIRESTONE	37
480/65R28		PERFORMER 65 — R-1W	003014	FIRESTONE	33
480/70R28		PERFORMER 70 — R-1W	004090	FIRESTONE	32
480/70R28	D	RADIAL ALL TRACTION DT — R-1W	351563	FIRESTONE	83
540/65R28		PERFORMER 65 — R-1W	003329	FIRESTONE	33
600/65R28		RADIAL ALL TRACTION DT — R-1W	371266	FIRESTONE	27
600/65R28	D	RADIAL ALL TRACTION DT — R-1W	360058	FIRESTONE	83

TIRES BY SIZE

TIRE SIZE		PATTERN NAME	MATERIAL NUMBER	BRAND	PAGE
600/70R28		RADIAL ALL TRACTION DT — R-1W	000907	FIRESTONE	27
600/70R28	D	RADIAL ALL TRACTION DT — R-1W	377522	FIRESTONE	83
VF600/70R28	D	RADIAL ALL TRACTION DT — R-1W	001602	FIRESTONE	83
VF600/70R38CFO		RADIAL ALL TRACTION DT — R-1W	004927	FIRESTONE	27
14.9-30	D	SUPER ALL TRACTION FWD — R-1	343951	FIRESTONE	86
16.9-30		SUPER ALL TRACTION II 23° — R-1	008563	FIRESTONE	43
16.9-30	D	FORESTRY SPECIAL WITH CRC — LS2	361844	FIRESTONE	81
16.9-30	D	SUPER ALL TRACTION II 23° — R-1	365282	FIRESTONE	85
16.9R30	D	RADIAL CHAMPION SPADE GRIP — R-2	359386	FIRESTONE	84
18.4-30		SUPER ALL TRACTION II 23° — R-1	372626	FIRESTONE	43
18.4-30		CHAMPION SPADE GRIP — R-2	342432	FIRESTONE	47
18.4-30		CHAMPION SPADE GRIP — R-2	008593	FIRESTONE	47
18.4-30	D	CHAMPION SPADE GRIP — R-2	358274	FIRESTONE	78
18.4-30	D	SUPER ALL TRACTION II 23° — R-1	365486	FIRESTONE	85
23.1-30		TRACTION FIELD & ROAD — R-1	364857	FIRESTONE	44
23.1-30		TRACTION FIELD & ROAD — R-1	008591	FIRESTONE	44
23.1-30		CHAMPION SPADE GRIP — R-2	311189	FIRESTONE	47
23.1-30	D	TRACTION FIELD & ROAD — R-1	338613	FIRESTONE	86
380/85R30		RADIAL ALL TRACTION DT — R-1W	364551	FIRESTONE	27
380/85R30		PERFORMER 85 — R-1W	000401	FIRESTONE	31
380/85R30		PERFORMER EVO — R-1W	007121	FIRESTONE	34
380/85R30		RADIAL ALL TRACTION FWD — R-1	362596	FIRESTONE	37
420/85R30		PERFORMER EVO — R-1W	007122	FIRESTONE	34
420/85R30		PERFORMER 85 — R-1W	000568	FIRESTONE	31
420/90R30		MAXI TRACTION — R-1W	011863	FIRESTONE	25
420/90R30		RADIAL ALL TRACTION DT — R-1W	364602	FIRESTONE	27
420/90R30		PERFORMER EVO — R-1W	008859	FIRESTONE	34
420/90R30		RADIAL ALL TRACTION FWD — R-1	362613	FIRESTONE	37
IF420/90R30		RADIAL ALL TRACTION DT — R-1W	004450	FIRESTONE	27
460/85R30		PERFORMER 85 — R-1W	000569	FIRESTONE	31
460/85R30		PERFORMER EVO — R-1W	007120	FIRESTONE	34
480/70R30		MAXI TRACTION — R-1W	011861	FIRESTONE	25
480/70R30		RADIAL ALL TRACTION DT — R-1W	355569	FIRESTONE	27
480/70R30		PERFORMER 70 — R-1W	002062	FIRESTONE	32
480/80R30	D	RADIAL ALL TRACTION DT — R-1W	362732	FIRESTONE	83
540/65R30		PERFORMER 65 — R-1W	000584	FIRESTONE	33

TIRES BY SIZE

TIRE SIZE		PATTERN NAME	MATERIAL NUMBER	BRAND	PAGE
600/70R30		RADIAL ALL TRACTION DT — R-1W	003778	FIRESTONE	27
600/70R30		RADIAL ALL TRACTION DT — R-1W	360163	FIRESTONE	27
600/70R30		RADIAL ALL TRACTION DT — R-1W	362307	FIRESTONE	27
IF600/70R30		MAXI TRACTION — R-1W	007312	FIRESTONE	25
IF600/70R30		RADIAL ALL TRACTION DT — R-1W	375703	FIRESTONE	27
VF600/70R30		RADIAL ALL TRACTION DT — R-1W	012319	FIRESTONE	27
620/75R30		MAXI TRACTION — R-1W	011477	FIRESTONE	25
IF620/75R30	D	RADIAL ALL TRACTION DT — R-1W	377535	FIRESTONE	83
9.5-32	D	FIELD & ROAD — R-1	304794	FIRESTONE	79
230/95R32		PERFORMER 95 — R-1W	008801	FIRESTONE	30
24.5-32		SUPER ALL TRACTION 23° — R-1	344079	FIRESTONE	41
24.5-32		CHAMPION SPADE GRIP — R-2	311626	FIRESTONE	47
24.5-32		ALL NON-SKID TRACTOR — R-3	322296	FIRESTONE	49
24.5-32		ALL NON-SKID TRACTOR — R-3	360384	FIRESTONE	49
24.5-32		PULLER 2000 — P-1	369685	FIRESTONE	51
24.5-32	D	FORESTRY SPECIAL WITH CRC — LS2	362704	FIRESTONE	81
24.5B32		FORESTRY SPECIAL WITH CRC (WTP)— LS-2	006284	FIRESTONE	71
24.5R32		RADIAL ALL TRACTION 23° — R-1	352926	FIRESTONE	36
30.5L-32		SUPER ALL TRACTION 23° — R-1	351075	FIRESTONE	41
30.5L-32		CHAMPION SPADE GRIP — R-2	358231	FIRESTONE	47
30.5L-32		ALL NON-SKID TRACTOR — R-3	357758	FIRESTONE	49
30.5L-32		PULLER 2000 — P-1	361992	FIRESTONE	51
30.5L-32	D	ALL NON-SKID TRACTOR — R-3	359904	FIRESTONE	77
30.5L-32	D	FORESTRY SPECIAL WITH CRC — LS2	371538	FIRESTONE	81
30.5L-32	D	SUPER ALL TRACTION 23° — R-1	344087	FIRESTONE	85
30.5L-32	D	SUPER ALL TRACTION 23° — R-1	351067	FIRESTONE	85
30.5LB32		FORESTRY SPECIAL WITH CRC (WTP)— LS-2	371555	FIRESTONE	71
30.5LB32		FORESTRY SPECIAL WITH CRC (WTP)— LS-2	004444	FIRESTONE	71
30.5LR32		RADIAL ALL TRACTION 23° — R-1	356204	FIRESTONE	36
35.5L-32		CHAMPION SPADE GRIP — R-2	358258	FIRESTONE	47
35.5L-32		ALL NON-SKID TRACTOR — R-3	357820	FIRESTONE	49
35.5LB32		FORESTRY SPECIAL WITH CRC (WTP)— LS-2	371606	FIRESTONE	71
35.5LB32		FORESTRY SPECIAL WITH CRC (WTP)— LS-2	004445	FIRESTONE	71
DH35.5LB32	D	FORESTRY SPECIAL WITH CRC — LS2	371572	FIRESTONE	81
650/75R32		RADIAL ALL TRACTION DT — R-1W	361925	FIRESTONE	27
650/75R32		RADIAL ALL TRACTION DT — R-1W	382486	FIRESTONE	27

TIRES BY SIZE

TIRE SIZE		PATTERN NAME	MATERIAL NUMBER	BRAND	PAGE
68X50.00-32	D	FLOTATION 23° DEEP TREAD (LOGGER) — HF-3	343137	FIRESTONE	80
73X44.00-32		FLOTATION 23° DEEP TREAD — HF-3	358835	FIRESTONE	76
73X44.00-32	D	FLOTATION 23° DEEP TREAD (LOGGER) — HF-3	343366	FIRESTONE	80
DH73X44.00B32		FLOTATION 23° EXTRA-DEEP TREAD LOGGER — HF-4	006279	FIRESTONE	72
76X50.00-32		FLOTATION 23° DEEP TREAD — HF-3	359866	FIRESTONE	76
76X50.00-32		FLOTATION 23° DEEP TREAD — HF-3	369702	FIRESTONE	76
76X50.00B32		FLOTATION 23° DEEP TREAD LOGGER — HF-3	359130	FIRESTONE	72
800/65R32		RADIAL ALL TRACTION DT — R-1W	382469	FIRESTONE	27
800/60R32	D	RADIAL ALL NON-SKID (ANS) — R-3	379171	FIRESTONE	83
800/65R32	D	RADIAL ALL TRACTION DT — R-1W	357685	FIRESTONE	83
IF800/60R32CFO		RADIAL ALL NON-SKID (ANS) — R-3	000911	FIRESTONE	40
900/60R32		RADIAL ALL TRACTION 23° — R-1	362800	FIRESTONE	36
IF900/60R32CFO		RADIAL ALL TRACTION 23° — R-1	000903	FIRESTONE	36
IF900/60R32CFO		RADIAL ALL TRACTION 23° — R-1	003149	FIRESTONE	36
900/65R32		RADIAL CHAMPION SPADE GRIP — R-2	375992	FIRESTONE	39
IF900/65R32CFO		RADIAL ALL NON-SKID (ANS) — R-3	000419	FIRESTONE	40
VF900/60R32CFO		MAXI TRACTION — R-1W	006311	FIRESTONE	25
900/75R32		RADIAL ALL TRACTION DT — R-1W	375958	FIRESTONE	27
IF900/75R32CFO		RADIAL ALL TRACTION DT — R-1W	004459	FIRESTONE	27
IF1250/50R32CFO		RADIAL DEEP TREAD 23° — R-1W	012318	FIRESTONE	26
IF1250/50R32CFO		RADIAL DEEP TREAD 23° — R-1W	004453	FIRESTONE	26
IF1250/50R32CFO		RADIAL DEEP TREAD 23° — R-1W	380446	FIRESTONE	26
24.5-32	D	FORESTRY SPECIAL WITH CRC — LS2	000408	FIRESTONE	81
18.4-34		SUPER ALL TRACTION 23° — R-1	343560	FIRESTONE	41
18.4-34		SUPER ALL TRACTION II 23° — R-1	372592	FIRESTONE	43
18.4-34		FORESTRY SPECIAL WITH CRC (WTP) — LS-2	361887	FIRESTONE	71
18.4-34	D	CHAMPION SPADE GRIP — R-2	311154	FIRESTONE	78
18.4-34	D	SUPER ALL TRACTION 23° — R-1	343676	FIRESTONE	85
18.4-34	D	SUPER ALL TRACTION II 23° — R-1	367203	FIRESTONE	85
18.4R34	D	RADIAL 23° — R-1W	354740	FIRESTONE	82
20.8-34		SUPER ALL TRACTION 23° — R-1	343579	FIRESTONE	41
23.1-34		SUPER ALL TRACTION 23° — R-1	008599	FIRESTONE	41
23.1-34	D	CHAMPION SPADE GRIP — R-2	311375	FIRESTONE	78
23.1-34	D	SUPER ALL TRACTION 23° — R-1	344109	FIRESTONE	85
23.1R34	D	RADIAL ALL TRACTION 23° — R-1W	352969	FIRESTONE	83
290/95R34	D	RADIAL 9000 — R-1W	359211	FIRESTONE	82

TIRES BY SIZE

TIRE SIZE		PATTERN NAME	MATERIAL NUMBER	BRAND	PAGE
320/85R34		RADIAL 9000 — R-1W	359238	FIRESTONE	29
380/85R34		RADIAL ALL TRACTION DT — R-1W	364585	FIRESTONE	27
380/85R34		PERFORMER EVO — R-1W	007483	FIRESTONE	34
380/85R34		RADIAL ALL TRACTION FWD — R-1	362630	FIRESTONE	37
380/85R34		RADIAL ALL TRACTION FWD — R-1	372286	FIRESTONE	37
380/85R34		RADIAL ALL TRACTION FWD — R-1	379290	FIRESTONE	37
IF380/85R34		RADIAL ALL TRACTION DT — R-1W	004449	FIRESTONE	27
420/85R34		RADIAL ALL TRACTION DT — R-1W	360155	FIRESTONE	27
420/85R34		RADIAL ALL TRACTION DT — R-1W	372133	FIRESTONE	27
420/85R34		PERFORMER 85 — R-1W	004241	FIRESTONE	31
420/85R34		PERFORMER EVO — R-1W	006349	FIRESTONE	34
IF420/85R34		RADIAL ALL TRACTION DT — R-1W	374513	FIRESTONE	27
VF420/85R34		RADIAL ALL TRACTION DT — R-1W	008686	FIRESTONE	27
460/85R34		PERFORMER 85 — R-1W	000586	FIRESTONE	31
460/85R34		PERFORMER EVO — R-1W	003168	FIRESTONE	34
480/70R34		RADIAL 9000 — R-1W	003779	FIRESTONE	29
480/70R34		RADIAL 9000 — R-1W	361763	FIRESTONE	29
480/70R34		PERFORMER 70 — R-1W	379324	FIRESTONE	32
480/70R34		RADIAL CHAMPION SPADE GRIP — R-2	369668	FIRESTONE	39
480/85R34	D	RADIAL ALL TRACTION 23° — R-1W	362392	FIRESTONE	83
520/70R34		PERFORMER 70 — R-1W	003516	FIRESTONE	32
520/85R34	D	RADIAL ALL TRACTION 23° — R-1W	369600	FIRESTONE	83
IF520/85R34	D	RADIAL ALL TRACTION 23° — R-1W	380395	FIRESTONE	83
540/65R34		PERFORMER 65 — R-1W	000546	FIRESTONE	33
IF580/80R34		RADIAL ALL TRACTION DT — R-1W	381585	FIRESTONE	27
VF650/60R34		MAXI TRACTION — R-1W	003187	FIRESTONE	25
9.5-36	D	TRACTION FIELD & ROAD — R-1	338443	FIRESTONE	86
11.2-36		FIELD & ROAD — R-1	304808	FIRESTONE	45
12.4-36	D	FIELD & ROAD — R-1	304816	FIRESTONE	79
13.6-36	D	FIELD & ROAD — R-1	304824	FIRESTONE	79
230/95R36		PERFORMER 95 — R-1W	011481	FIRESTONE	30
320/85R36		PERFORMER 85 — R-1W	011480	FIRESTONE	31
11.2-38		FIELD & ROAD — R-1	355003	FIRESTONE	45
11.2-38		FIELD & ROAD — R-1	000929	FIRESTONE	45
12.4-38		FIELD & ROAD — R-1	304840	FIRESTONE	45
12.4-38		FIELD & ROAD — R-1	354805	FIRESTONE	45

TIRES BY SIZE

TIRE SIZE		PATTERN NAME	MATERIAL NUMBER	BRAND	PAGE
12.4-38	D	FIELD & ROAD — R-1	304921	FIRESTONE	79
12.4-38	D	SUPER ALL TRACTION 23° — R-1	355577	FIRESTONE	85
13.6-38		TRACTION FIELD & ROAD — R-1	338087	FIRESTONE	44
13.6-38		TRACTION FIELD & ROAD — R-1	011866	FIRESTONE	44
13.6-38		CHAMPION SPADE GRIP — R-2	008527	FIRESTONE	47
13.6-38	D	CHAMPION SPADE GRIP — R-2	379885	FIRESTONE	78
13.6-38	D	TRACTION FIELD & ROAD — R-1	338036	FIRESTONE	86
14.9-38		TRACTION FIELD & ROAD — R-1	008571	FIRESTONE	44
14.9-38	D	TRACTION FIELD & ROAD — R-1	338516	FIRESTONE	86
15.5-38		SUPER ALL TRACTION II 23° — R-1	372524	FIRESTONE	43
15.5-38	D	CHAMPION SPADE GRIP — R-2	311219	FIRESTONE	78
15.5R38		RADIAL 23° — R-1	354767	FIRESTONE	38
16.9-38		SUPER ALL TRACTION 23° — R-1	343587	FIRESTONE	41
16.9-38	D	TRACTION FIELD & ROAD — R-1	338141	FIRESTONE	86
18.4-38		SUPER ALL TRACTION 23° — R-1	343595	FIRESTONE	41
18.4-38		SUPER ALL TRACTION II 23° — R-1	372507	FIRESTONE	43
18.4-38	D	CHAMPION SPADE GRIP — R-2	343110	FIRESTONE	78
18.4-38	D	CHAMPION SPADE GRIP — R-2	311448	FIRESTONE	78
18.4R38	D	RADIAL 23° — R-1W	359823	FIRESTONE	82
18.4R38	D	RADIAL CHAMPION SPADE GRIP — R-2	353140	FIRESTONE	84
20.8-38		SUPER ALL TRACTION 23° — R-1	343609	FIRESTONE	41
20.8-38		SUPER ALL TRACTION II 23° — R-1	367237	FIRESTONE	43
20.8-38	D	SUPER ALL TRACTION 23° — R-1	343633	FIRESTONE	85
20.8R38		RADIAL 23° — R-1	362204	FIRESTONE	38
20.8R38		RADIAL CHAMPION SPADE GRIP — R-2	353167	FIRESTONE	39
290/85D38		CHAMPION HYDRO ND — R-1	003147	FIRESTONE	46
290/85D38	D	CHAMPION HYDRO ND — R-1	374785	FIRESTONE	78
320/85R38		RADIAL 9000 — R-1W	359092	FIRESTONE	29
320/85R38	D	RADIAL 9000 — R-1W	360074	FIRESTONE	82
380/80R38		RADIAL ALL TRACTION DT — R-1W	360171	FIRESTONE	27
IF380/80R38		RADIAL ALL TRACTION DT — R-1W	378627	FIRESTONE	27
VF380/80R38		RADIAL ALL TRACTION DT — R-1W	008685	FIRESTONE	27
IF380/80R38		RADIAL CHAMPION SPADE GRIP — R-2	006364	FIRESTONE	39
VF380/95R38		RADIAL ALL TRACTION DT — R-1W	000908	FIRESTONE	27
400/75R38		PERFORMER EVO — R-1W	003156	FIRESTONE	34
420/85R38		PERFORMER EVO — R-1W	005285	FIRESTONE	34

TIRES BY SIZE

TIRE SIZE		PATTERN NAME	MATERIAL NUMBER	BRAND	PAGE
420/85R38	D	PERFORMER 85 — R-1W	000598	FIRESTONE	81
420/85R38	D	RADIAL ALL TRACTION 23° — R-1W	379120	FIRESTONE	83
IF420/85R38		RADIAL ALL TRACTION DT — R-1W	378882	FIRESTONE	27
VF420/85R38		RADIAL ALL TRACTION DT — R-1W	008857	FIRESTONE	27
460/85R38		PERFORMER 85 — R-1W	000587	FIRESTONE	31
460/85R38		PERFORMER EVO — R-1W	003158	FIRESTONE	34
480/70R38		PERFORMER 70 — R-1W	379358	FIRESTONE	32
480/80R38		RADIAL ALL TRACTION 23° — R-1	362341	FIRESTONE	36
480/80R38	D	RADIAL DEEP TREAD 23° — R-1W	362749	FIRESTONE	84
520/70R38		PERFORMER 70 — R-1W	379919	FIRESTONE	32
520/85D38		SUPER ALL TRACTION HD — R-1	363038	FIRESTONE	42
520/85R38		RADIAL DEEP TREAD 23° — R-1W	362766	FIRESTONE	26
520/85R38		PERFORMER 85 — R-1W	000602	FIRESTONE	31
520/85R38		RADIAL ALL TRACTION 23° — R-1	362375	FIRESTONE	36
580/70R38		PERFORMER 70 — R-1W	002063	FIRESTONE	32
800/70R38		RADIAL DEEP TREAD 23° — R-1W	359548	FIRESTONE	26
650/85R38		RADIAL DEEP TREAD 23° — R-1W	362987	FIRESTONE	26
650/85R38		RADIAL DEEP TREAD 23° — R-1W	000922	FIRESTONE	26
650/65R38		RADIAL 9000 — R-1W	000403	FIRESTONE	29
710/70R38		RADIAL ALL TRACTION DT — R-1W	355542	FIRESTONE	27
IF710/70R38		RADIAL ALL TRACTION DT — R-1W	378219	FIRESTONE	27
800/70R38		MAXI TRACTION — R-1W	006344	FIRESTONE	25
800/70R38	D	RADIAL DEEP TREAD 23° — R-1W	378525	FIRESTONE	84
IF800/70R38		MAXI TRACTION — R-1W	008795	FIRESTONE	25
IF800/70R38		RADIAL DEEP TREAD 23° — R-1W	378746	FIRESTONE	26
IF800/70R38CFO		RADIAL DEEP TREAD 23° — R-1W	003144	FIRESTONE	26
IF800/70R38CFO	D	RADIAL DEEP TREAD 23° — R-1W	000928	FIRESTONE	84
VF800/70R38		MAXI TRACTION — R-1W	004509	FIRESTONE	25
VF800/70R38CFO		MAXI TRACTION — R-1W	006309	FIRESTONE	25
9.5-42	D	TRACTION FIELD & ROAD — R-1	338532	FIRESTONE	86
12.4-42		TRACTION FIELD & ROAD — R-1	358630	FIRESTONE	44
12.4-42		TRACTION FIELD & ROAD — R-1	008566	FIRESTONE	44
12.4-42	D	TRACTION FIELD & ROAD — R-1	355097	FIRESTONE	86
18.4-42	D	SUPER ALL TRACTION 23° — R-1	343641	FIRESTONE	85
18.4R42	D	RADIAL 23° — R-1W	362212	FIRESTONE	82
20.8-42	D	CHAMPION SPADE GRIP — R-2	352918	FIRESTONE	78

TIRES BY SIZE

TIRE SIZE		PATTERN NAME	MATERIAL NUMBER	BRAND	PAGE
20.8-42	D	SUPER ALL TRACTION 23° — R-1	352888	FIRESTONE	85
20.8-42	D	SUPER ALL TRACTION 23° — R-1	343668	FIRESTONE	85
20.8R42		RADIAL 23° — R-1	355399	FIRESTONE	38
320/90R42		RADIAL 9000 — R-1W	359106	FIRESTONE	29
460/85R42		PERFORMER 85 — R-1W	382078	FIRESTONE	31
480/80R42		RADIAL DEEP TREAD 23° — R-1W	362409	FIRESTONE	26
480/80R42		RADIAL DEEP TREAD 23° — R-1W	364058	FIRESTONE	26
480/80R42		PERFORMER EVO 23° — R-1W	009132	FIRESTONE	35
480/80R42		RADIAL ALL TRACTION 23° — R-1	362324	FIRESTONE	36
480/80R42		RADIAL ALL TRACTION 23° — R-1	364092	FIRESTONE	36
520/85R42		RADIAL DEEP TREAD 23° — R-1W	362426	FIRESTONE	26
520/85R42		RADIAL DEEP TREAD 23° — R-1W	009320	FIRESTONE	26
520/85R42		RADIAL DEEP TREAD 23° — R-1W	381823	FIRESTONE	26
520/85R42		RADIAL DEEP TREAD 23° — R-1W	009316	FIRESTONE	26
520/85R42		PERFORMER 85 — R-1W	000628	FIRESTONE	31
520/85R42		RADIAL ALL TRACTION 23° — R-1	362358	FIRESTONE	36
520/85R42		RADIAL CHAMPION SPADE GRIP — R-2	371198	FIRESTONE	39
520/85R42		RADIAL CHAMPION SPADE GRIP — R-2	371215	FIRESTONE	39
IF520/85R42CFO		RADIAL DEEP TREAD 23° — R-1W	000921	FIRESTONE	26
IF520/85R42CFO		RADIAL ALL TRACTION 23° — R-1	000560	FIRESTONE	36
IF520/85R42CFO		RADIAL CHAMPION SPADE GRIP — R-2	003170	FIRESTONE	39
VF520/85R42CFO		RADIAL DEEP TREAD 23° — R-1W	009318	FIRESTONE	26
580/85R42		RADIAL DEEP TREAD 23° — R-1W	382452	FIRESTONE	26
580/70R42		PERFORMER 70 — R-1W	006558	FIRESTONE	32
IF580/85R42CFO		RADIAL DEEP TREAD 23° — R-1W	003148	FIRESTONE	26
VF580/85R42CFO		RADIAL DEEP TREAD 23° — R-1W	007123	FIRESTONE	26
620/70R42		MAXI TRACTION — R-1W	003891	FIRESTONE	25
620/70R42		RADIAL ALL TRACTION DT — R-1W	356271	FIRESTONE	27
620/70R42		RADIAL ALL TRACTION DT — R-1W	374479	FIRESTONE	27
710/70R42		MAXI TRACTION — R-1W	006343	FIRESTONE	25
710/70R42		RADIAL ALL TRACTION DT — R-1W	003780	FIRESTONE	27
710/70R42		RADIAL ALL TRACTION DT — R-1W	358320	FIRESTONE	27
IF710/70R42		MAXI TRACTION — R-1W	008799	FIRESTONE	25
IF710/70R42		RADIAL ALL TRACTION DT — R-1W	378542	FIRESTONE	27
IF710/70R42	D	RADIAL ALL TRACTION DT — R-1W	373697	FIRESTONE	83
IF710/70R42CFO		RADIAL ALL TRACTION DT — R-1W	004592	FIRESTONE	27

TIRES BY SIZE

TIRE SIZE		PATTERN NAME	MATERIAL NUMBER	BRAND	PAGE
VF710/70R42		MAXI TRACTION — R-1W	004513	FIRESTONE	25
VF710/70R42CFO		MAXI TRACTION — R-1W	006306	FIRESTONE	25
IF850/75R42	D	RADIAL DEEP TREAD 23° — R-1W	376162	FIRESTONE	84
IF850/75R42CFO		RADIAL DEEP TREAD 23° — R-1W	004469	FIRESTONE	26
900/50R42		RADIAL 9000 — R-1W	359394	FIRESTONE	29
VF900/60R42		MAXI TRACTION — R-1W	006338	FIRESTONE	25
IF1100/50R42CFO		MAXI TRACTION — R-1W	004454	FIRESTONE	25
230/95R44		PERFORMER 95 — R-1W	008802	FIRESTONE	30
13.6-46		CHAMPION SPADE GRIP — R-2	000917	FIRESTONE	47
13.6-46		CHAMPION SPADE GRIP — R-2	008528	FIRESTONE	47
14.9R46		RADIAL ALL TRACTION 23° — R-1	343323	FIRESTONE	36
320/90R46		RADIAL 9000 — R-1W	357774	FIRESTONE	29
320/90R46		RADIAL CHAMPION SPADE GRIP — R-2	363004	FIRESTONE	39
380/90R46		RADIAL 9000 — R-1W	359939	FIRESTONE	29
380/90R46		RADIAL 9000 — R-1W	007435	FIRESTONE	29
IF380/90R46		RADIAL ALL TRACTION RC — R-1W	005478	FIRESTONE	28
IF380/90R46	D	RADIAL ALL TRACTION RC — R-1W	000629	FIRESTONE	84
VF380/90R46		RADIAL ALL TRACTION RC — R-1W	005544	FIRESTONE	28
VF380/90R46	D	RADIAL ALL TRACTION RC — R-1W	380412	FIRESTONE	84
420/80R46		RADIAL ALL TRACTION 23° — R-1	352829	FIRESTONE	36
IF420/80R46		RADIAL ALL TRACTION 23° — R-1	000558	FIRESTONE	36
VF420/80R46		RADIAL ALL TRACTION RC — R-1W	011859	FIRESTONE	28
480/80R46		RADIAL DEEP TREAD 23° — R-1W	009138	FIRESTONE	26
480/80R46		PERFORMER EVO 23° — R-1W	009133	FIRESTONE	35
480/80R46		RADIAL ALL TRACTION 23° — R-1	362273	FIRESTONE	36
480/80R46	D	RADIAL DEEP TREAD 23° — R-1W	362256	FIRESTONE	84
IF480/80R46	D	RADIAL DEEP TREAD 23° — R-1W	004451	FIRESTONE	84
VF480/80R46		RADIAL DEEP TREAD 23° — R-1W	010051	FIRESTONE	26
VF480/80R46	D	RADIAL DEEP TREAD 23° — R-1W	009134	FIRESTONE	84
520/85R46		RADIAL DEEP TREAD 23° — R-1W	362851	FIRESTONE	26
520/85R46		RADIAL CHAMPION SPADE GRIP — R-2	369651	FIRESTONE	39
IF520/85R46		RADIAL DEEP TREAD 23° — R-1W	378610	FIRESTONE	26
VF520/85R46		RADIAL DEEP TREAD 23° — R-1W	008680	FIRESTONE	26
620/70R46		MAXI TRACTION — R-1W	008864	FIRESTONE	25
VF620/70R46		MAXI TRACTION — R-1W	004457	FIRESTONE	25
230/85R48		PERFORMER 95 — R-1W	006361	FIRESTONE	30

TIRES BY SIZE

TIRE SIZE		PATTERN NAME	MATERIAL NUMBER	BRAND	PAGE
230/95R48	D	RADIAL 9000 — R-1W	356263	FIRESTONE	82
270/95R48		PERFORMER 95 — R-1W	011475	FIRESTONE	30
320/90R50		RADIAL 9000 — R-1W	358118	FIRESTONE	29
380/90R50		RADIAL 9000 — R-1W	362050	FIRESTONE	29
VF380/90R50		RADIAL ALL TRACTION RC — R-1W	006358	FIRESTONE	28
380/105R50		RADIAL 9100 — R-1	362919	FIRESTONE	38
IF380/105R50		RADIAL ALL TRACTION RC — R-1W	000905	FIRESTONE	28
VF380/105R50		RADIAL ALL TRACTION RC — R-1W	308429	FIRESTONE	28
480/80R50		RADIAL DEEP TREAD 23° — R-1W	360090	FIRESTONE	26
480/80R50		RADIAL DEEP TREAD 23° — R-1W	372150	FIRESTONE	26
480/80R50		RADIAL CHAMPION SPADE GRIP — R-2	006363	FIRESTONE	39
IF480/80R50		RADIAL DEEP TREAD 23° — R-1W	374496	FIRESTONE	26
VF480/80R50		RADIAL DEEP TREAD 23° — R-1W	007493	FIRESTONE	26
IF480/95R50		RADIAL DEEP TREAD 23° — R-1W	011478	FIRESTONE	26
IF480/95R50		RADIAL DEEP TREAD 23° — R-1W	375635	FIRESTONE	26
VF480/95R50		RADIAL DEEP TREAD 23° — R-1W	007494	FIRESTONE	26
VF480/95R50		RADIAL DEEP TREAD 23° — R-1W	011479	FIRESTONE	26
320/90R54		RADIAL ALL TRACTION DT — R-1W	358339	FIRESTONE	27
380/90R54		RADIAL 9000 — R-1W	362069	FIRESTONE	29

TABLE OF CONTENTS

	PAGE
FARM & FORESTRY TIRES	
RADIAL FARM	
MAXI TRACTION — R-1W	25
RADIAL DEEP TREAD 23° — R-1W	26
RADIAL ALL TRACTION DT — R-1W	27
RADIAL ALL TRACTION RC — R-1W	28
RADIAL 9000 — R-1W	29
RADIAL 8000 UTILITY — R-1W	30
PERFORMER 95 — R-1W	30
PERFORMER 85 — R-1W	31
PERFORMER 70 — R-1W	32
PERFORMER 65 — R-1W	33
PERFORMER EVO — R-1W	34
PERFORMER EVO 23° — R-1W	35
RADIAL 4000 — R-1W	35
RADIAL ALL TRACTION 23° — R-1	36
RADIAL ALL TRACTION FWD — R-1	37
RADIAL 9100 — R-1	38
RADIAL 23° — R-1	38
RADIAL CHAMPION SPADE GRIP — R-2	39
RADIAL ALL NON-SKID (ANS) — R-3	40
BIAS FARM	
SUPER ALL TRACTION 23° — R-1	41
SUPER ALL TRACTION FWD — R-1	42
SUPER ALL TRACTION HD — R-1	42
SUPER ALL TRACTION II 23° — R-1	43
TRACTION FIELD & ROAD — R-1	44
FIELD & ROAD — R-1	45
CHAMPION HYDRO ND — R-1	46
IRRIGATION SPECIAL — R-1	46
CHAMPION SPADE GRIP — R-2	47
TURF & FIELD — R-3	48
ALL NON-SKID TRACTOR — R-3	49
ALL NON-SKID TRACTOR II — R-3	50
ALL TRACTION UTILITY — R-4	50
PULLER 2000 — P-1	51
DURAFORCE ND — NHS	51

	PAGE
FRONTS & IMPLEMENTS	
DESTINATION FARM — I-1	52
DESTINATION TURF — I-2	53
CHAMPION GUIDE GRIP 4-RIB — F-2	54
CHAMPION GUIDE GRIP 3-RIB — F-2	55
GUIDE GRIP 3-RIB — F-2	56
INDUSTRIAL SPECIAL — F-3	56
HIGHWAY SPECIAL — I-1	57
FARM IMPLEMENT — I-1	58
FARM TIRE — I-1	59
RIB IMPLEMENT — I-1	60
RIB DUPLEX FARM — I-1	61
DUO RIB PLANTER — I-1	61
ALL NON-SKID (ANS) FARM — I-2	62
TURF & FIELD — I-3	62
POWER IMPLEMENT — I-3	63
NON-DIRECTIONAL DUPLEX FARM — I-3	63
FLOTATION IMPLEMENT — I-3	64
SUPER TRACTION LOADER — I-3	64
FLOTATION 23° — HF-3	65
FARM IMPLEMENT — HF-1	65
TURF & FIELD — HF-2	66
BRIDGESTONE BIAS FARM	
FARM SERVICE LUG-M — R-1	67
FARM SERVICE LUG-18 — R-1	67
FARM SERVICE DIA — R-3	68
FARM SERVICE RIB — F-2	68
REGENCY BIAS FARM	
AG IMPLEMENT — I-1	69
AG FRONT 4-RIB — F-2	69
AG FRONT 3-RIB — F-2	70
AG TRACTOR — G-1	70
FORESTRY & FLOTATION	
FORESTRY	
FORESTRY SPECIAL WITH CRC (WTP)— LS-2	71
FLOTATION 23° DEEP TREAD LOGGER—HF-3	72
FLOTATION 23° EXTRA-DEEP TREAD LOGGER — HF-4	72

TABLE OF CONTENTS

	PAGE
FARM & FORESTRY TIRES	
FORESTRY & FLOTATION	
FORESTRY	
FLOTATION 23° DEEP TREAD (WTP) LOGGER —HF-4	73
FORESTY EL 700 — HF-1	73
FLOTATION	
FLOTATION ALL TERRAIN — HF-1	74
FLOTATION 23° (CENTER RIB) — HF-2	75
FLOTATION FREE ROLLING — HF-2	75
FLOTATION 23° DEEP TREAD — HF-3	76
DISCONTINUED TIRES	77
LOAD & INFLATION TABLES	89
GENERAL TIRE INFORMATION	
INTERNATIONAL LOAD INDEX NUMBERS	165
GENERAL TIRE INFORMATION	166
HOW TO READ AN RCI CHART	168
APPROVED RIM CONTOURS	170
HYDROINFLATION	175
WARNING & SAFETY PRECAUTIONS	185
MEASURING AND CORRECTING LEAD/LAG	188
POWER HOP	192
WARRANTY	
PREMIUM RADIAL WARRANTY	195
PEFORMER EVO WARRANTY	197
BIAS WARRANTY	199
FORESTRY WARRANTY	201
FIELD HAZARD POLICY	203
STUBBLE POLICY	204

MAXI TRACTION — R-1W



IF- and VF-designated tires feature AD₂ technology, which helps farmers carry heavier loads at the same pressure as standard tires, or the same loads at reduced inflation pressure. This leads to reduced fuel use and reduced soil compaction.

R-1W tread depth for flexibility in a variety of soil conditions. Features dual-angle technology to increase contact area.

Steeper bar taper for improved irregular-wear resistance and a more comfortable ride.

TIRE SIZE	MATERIAL NUMBER	LOAD INDEX	SPEED SYMBOL RATING	TIRE DIMENSIONS (IN.)								CONTACT AREA	
				DESIGN RIM WIDTH	OVERALL WIDTH	OVERALL DIA.	STATIC LOADED RADIUS	ROLLING CIRCUM.	ROLLING CIRCUM. INDEX	BAR HEIGHT 32NDS	BAR HEIGHT INCHES	FLAT PLATE (SQ. IN.)	MAX. LOAD & INFL. (LBS. @ PSI)
TUBELESS													
420/85R26	008851	138	D	15.00	16.8	54.4	24.5	162	-	62	1.94	227	5200@23
750/65R26	006304	169	B	25.00	29.3	65.2	29.2	192	-	73	2.28	467	12800@41
VF750/65R26CFO	006305	177	B	25.00	29.4	63.9	27.5	188	-	73	2.28	530	16100@35
420/90R30	011863	145	D	15.00	17.8	59.6	27.1	178	42	67	2.08	251	6400@29
480/70R30	011861	152	D	15.00	18.0	58.7	26.7	176	42	61	1.92	244	7850@46
620/75R30	011477	163	D	20.00	24.4	66.4	30.0	200	44	74	2.31	-	10700@35
IF600/70R30	007312	165	D	20.00	24.3	62.9	27.9	186	43	74	2.31	397	11400@35
VF900/60R32CFO	006311	193	B	30.00	34.5	73.7	31.8	217	46	84	2.64	745	25400@46
VF650/60R34	003187	168	D	23.00	25.8	64.4	28.1	191	-	69	2.16	493	12300@29
800/70R38	006344	173	D	25.00	31.7	81.5	35.9	243	48	77	2.40	782	14300@23
IF800/70R38	008795	179	D	27.00	32.0	81.8	35.3	243	48	77	2.40	830	17100@23
VF800/70R38	004509	187	D	27.00	32.8	81.9	35.1	243	48	77	2.40	881	21500@29
VF800/70R38CFO	006309	193	B	27.00	32.3	82.4	35.5	245	48	77	2.40	887	25400@41
620/70R42	003891	166	D	20.00	25.1	76.0	34.4	229	47	71	2.22	-	11700@35
710/70R42	006343	168	D	23.00	28.5	81.8	36.3	245	48	74	2.30	630	12300@23
IF710/70R42	008799	179	D	25.00	29.0	80.8	36.0	241	48	74	2.30	651	17100@35
VF710/70R42	004513	184	D	25.00	29.0	80.8	35.4	241	48	74	2.30	699	19800@35
VF710/70R42CFO	006306	184	B	25.00	29.0	80.8	35.4	241	48	74	2.30	712	19800@35
VF900/60R42	006338	189	D	30.00	34.7	84.0	36.0	250	-	84	2.64	869	22700@29
IF1100/50R42CFO	004454	197	B	38.00	42.4	84.2	37.1	251	-	72	2.25	979	28300@46
620/70R46	008864	167	B	20.00	24.6	79.7	36.1	239	-	72	2.24	470	12000@35
VF620/70R46	004457	179	D	21.00	23.9	79.5	35.1	238	-	72	2.24	563	17100@35

 Addition from previous data book

See General Farm Tire Information, Approved Rim Contours (pages 168-172) for a listing of approved rim contours by tire size.
See Load & Inflation Tables (pages 92-163) for more details.

RADIAL DEEP TREAD 23° — R-1W



With Firestone's innovative 23° tread design, more of the bar grips the surface, making it ideal for farmers looking for increased traction while more efficiently transferring horsepower to the ground, saving both time and fuel¹.

IF- and VF-designated tires feature AD₂ technology, which helps farmers carry heavier loads at the same pressure as standard tires, or the same loads at reduced inflation pressure. This leads to reduced fuel use and reduced soil compaction.

Designed with R-1W tread depth that's approximately 25% deeper in the center compared with standard R-1 tread, offering traction in a variety of soil conditions.

TIRE DIMENSIONS (IN.)													CONTACT AREA	
TIRE SIZE	MATERIAL NUMBER	LOAD INDEX	SPEED SYMBOL RATING	DESIGN RIM WIDTH	OVERALL WIDTH	OVERALL DIA.	STATIC LOADED RADIUS	ROLLING CIRCUM.	ROLLING CIRCUM. INDEX	BAR HEIGHT 32NDS	BAR HEIGHT INCHES	FLAT PLATE (SQ. IN.)	MAX. LOAD & INFL. (LBS. @ PSI)	
TUBELESS														
IF1250/50R32CFO	012318	195	B	44.00	51.7	81.4	35.1	241	48	74	2.31	1010	26800@35	
520/85R38	362766	155	B	16.00	21.0	72.7	32.6	215	46	69	2.16	410	8550@23	
650/85R38	362987	173	B	23.00	27.6	79.9	36.0	242	48	70	2.19	550	14300@35	
650/85R38	000922	173	D	23.00	27.6	79.9	36.0	242	48	70	2.19	550	14300@35	
800/70R38	359548	173	B	25.00	31.3	81.9	36.0	243	48	74	2.31	570	14300@23	
IF800/70R38	378746	179	B	27.00	31.7	80.2	34.4	243	48	74	2.31	686	17100@23	
IF800/70R38CFO	003144	187	B	27.00	33.0	81.1	35.9	243	48	74	2.31	697	21500@41	
480/80R42	362409	151	B	16.00	19.2	73.2	33.5	218	46	63	1.97	360	7600@23	
480/80R42	364058	154	B	16.00	19.2	73.2	33.5	218	46	63	1.97	360	8250@29	
520/85R42	362426	157	B	18.00	21.8	76.2	34.5	228	47	69	2.16	440	9100@23	
520/85R42	009320	157	B	18.00	20.8	76.3	34.5	228	47	69	2.16	402	9100@23	
520/85R42	381823	165	B	18.00	21.8	76.2	34.5	228	47	69	2.16	440	11400@41	
520/85R42	009316	165	B	18.00	21.0	76.1	32.1	228	47	69	2.16	396	11400@41	
IF520/85R42CFO	000921	169	B	18.00	22.4	76.3	34.4	228	47	69	2.16	452	12800@35	
VF520/85R42CFO	009318	177	B	18.00	20.91	76.1	34.0	227	47	69	2.16	504	16100@41	
580/85R42	382452	166	B	18.00	22.7	80.9	34.5	228	48	71	2.22	440	11700@29	
IF580/85R42CFO	003148	178	B	20.00	23.9	80.9	36.6	242	48	72	2.25	450	16500@41	
VF580/85R42CFO	007123	183	B	20.00	23.9	81.1	36.6	241	48	72	2.25	450	19300@41	
IF850/75R42CFO	004469	186	B	30.00	34.2	91.7	39.5	272	50	78	2.44	872	20900@23	
480/80R46	009138	158	B	16.00	18.9	76.8	35.5	231	47	63	1.97	356	9350@35	
VF480/80R46	010051	169	B	16.00	18.8	77.0	34.6	231	47	62	1.94	459	12800@35	
520/85R46	362851	158	B	16.00	20.9	80.8	36.6	242	48	64	2.00	450	9350@23	
IF520/85R46	378610	165	B	18.00	20.9	80.8	35.5	242	48	69	2.16	562	11400@23	
VF520/85R46	008680	170	B	18.00	21.5	79.9	34.9	242	48	69	2.16	587	13200@23	
480/80R50	360090	159	B	15.00	19.0	80.8	37.0	243	48	63	1.97	380	9650@35	
480/80R50	372150	159	B	15.00	19.0	80.8	37.0	243	48	63	1.97	380	9650@35	
IF480/80R50	374496	166	B	15.00	19.1	80.6	36.8	243	48	63	1.97	431	11700@35	
VF480/80R50	007493	171	B	15.00	19.1	80.6	36.8	242	48	63	1.97	481	13600@35	
IF480/95R50	011478	165	B	15.00	18.3	85.5	38.4	258	49	73	2.28	520	11400@23	
IF480/95R50	375635	165	B	15.00	19.9	85.9	38.1	258	49	65	2.03	465	11400@23	
VF480/95R50	007494	170	B	15.00	19.1	80.6	36.8	257	49	63	1.97	431	13200@23	
VF480/95R50	011479	170	B	15.00	18.3	85.8	37.7	257	49	73	2.28	566	13200@23	
IF1250/50R32CFO	004453	188	B	44.00	50.6	82.5	34.9	240	48	74	2.31	1086	22000@23	
IF1250/50R32CFO	380446	201	B	44.00	50.6	82.5	34.9	240	48	74	2.31	1086	32000@46	

¹ Compared to 45° tread pattern design. Results may vary.

See General Farm Tire Information, Approved Rim Contours (pages 168-172) for a listing of approved rim contours by tire size. See Load & Inflation Tables (pages 92-163) for more details.

RADIAL FARM

BIAS FARM

FRONTS & IMPLEMENTS

FORESTRY & FLOTATION

DISCONTINUED

LOAD & INFLATION TABLES

GENERAL TIRE INFORMATION

WARRANTY

RADIAL ALL TRACTION DT — R-1W



Available with up to 54" rim diameter, allowing for high row-crop clearance.

Designed with R-1W tread depth that is approximately 25% deeper in the center compared with standard R-1 tread, offering traction in a variety of soil conditions.

IF- and VF-designated tires feature AD₂ technology, which helps farmers carry heavier loads at the same pressure as standard tires, or the same loads at reduced inflation pressure. This leads to reduced fuel use and reduced soil compaction.

TIRE SIZE	MATERIAL NUMBER	LOAD INDEX	SPEED SYMBOL RATING	TIRE DIMENSIONS (IN.)								CONTACT AREA	
				DESIGN RIM WIDTH	OVERALL WIDTH	OVERALL DIA.	STATIC LOADED RADIUS	ROLLING CIRCUM.	ROLLING CIRCUM. INDEX	BAR HEIGHT 32NDS	BAR HEIGHT INCHES	FLAT PLATE (SQ. IN.)	MAX. LOAD & INFL. (LBS. @ PSI)
TUBELESS													
380/85R24	362715	131	B	12.00	15.0	49.0	22.0	148	38	55	1.72	180	4300@23
750/65R26	000906	169	B	25.00	30.1	64.1	28.9	192	-	67	2.09	453	12800@41
VF750/65R26	000556	177	B	25.00	30.3	64.0	27.4	190	-	67	2.09	534	16100@35
VF620/75R26	001603	172	B	20.00	24.5	62.1	26.6	184	43	66	2.06	476	13900@35
VF620/75R26CFO	008684	172	B	20.00	24.5	62.1	26.6	183	-	67	2.09	476	13900@35
600/65R28	371266	154	B	18.00	23.0	58.7	26.1	174	42	65	2.03	330	8250@35
600/70R28	000907	164	B	18.00	23.8	60.7	27.1	178	42	65	2.03	355	11000@46
VF600/70R28CFO	004927	173	B	21.00	24.4	60.9	26.6	181	-	65	2.03	390	14300@41
380/85R30	364551	135	B	13.00	15.5	55.8	25.6	157	41	61	1.91	190	4800@23
420/90R30	364602	145	B	15.00	17.7	58.8	26.8	174	42	62	1.94	235	6400@29
IF420/90R30	004450	151	B	15.00	17.7	58.4	25.9	176	-	62	1.94	292	7600@29
480/70R30	355569	152	B	15.00	19.0	59.7	26.9	177	42	55	1.72	275	7850@46
600/70R30	003778	152	A8	24.00	24.0	62.8	27.9	187	43	65	2.03	370	7850@23
600/70R30	360163	152	B	20.00	24.0	62.8	27.9	187	43	65	2.03	370	7850@23
600/70R30	362307	162	B	20.00	24.0	62.9	28.0	187	43	65	2.03	370	10500@41
IF600/70R30	375703	159	B	20.00	24.4	62.6	27.2	187	43	64	2.00	425	9650@23
VF600/70R30	012319	165	D	20.00	24.2	62.1	26.6	184	-	64	2.00	452	11400@23
650/75R32	361925	172	B	21.00	26.0	70.2	31.5	210	45	70	2.19	450	13900@46
650/75R32	382486	172	D	21.00	26.0	70.2	31.5	210	45	70	2.19	450	13900@46
800/65R32	382469	172	D	25.00	32.6	72.1	32.7	216	46	74	2.31	575	13900@35
900/75R32	375958	184	B	30.00	37.0	85.5	37.8	253	49	82	2.56	761	19800@35
IF900/75R32CFO	004459	178	B	30.00	36.6	84.5	36.2	253	49	82	2.56	895	16500@17
380/85R34	364585	137	B	13.00	15.5	59.8	27.6	179	42	61	1.91	210	5080@23
IF380/85R34	004449	149	B	13.00	15.7	59.9	27.2	179	-	61	1.91	243	7150@35
420/85R34	360155	147	B	13.00	16.5	62.6	28.4	187	43	59	1.84	245	6800@35
420/85R34	372133	147	B	13.00	16.5	62.6	28.4	187	43	59	1.84	245	6800@35
IF420/85R34	374513	152	B	14.00	16.3	62.4	28.0	187	43	59	1.84	283	7850@29
VF420/85R34	008686	157	B	14.00	17.1	62.0	27.1	185	43	59	1.84	318	9100@29
IF580/80R34	381585	172	B	20.00	23.5	70.0	31.2	209	45	73	2.28	415	13900@41
380/80R38	360171	142	B	12.00	15.3	62.8	28.8	187	43	57	1.78	230	5840@35
IF380/80R38	378627	149	B	12.00	15.3	62.8	28.8	187	43	57	1.78	230	6950@35
VF380/80R38	008685	154	B	12.00	15.2	62.2	28.2	186	43	57	1.78	258	8250@35
VF380/95R38	000908	154	B	13.00	15.1	66.4	29.6	199	44	56	1.75	300	8250@23
IF420/85R38	378882	153	B	14.00	16.7	66.1	29.7	198	44	59	1.84	297	8050@29
VF420/85R38	008857	159	B	14.00	17.2	66.0	29.1	197	44	59	1.84	335	9650@29
710/70R38	355542	166	B	23.00	28.3	77.0	34.0	227	47	74	2.31	505	11700@23
IF710/70R38	378219	166	B	25.00	29.6	76.2	33.6	227	47	74	2.31	580	16500@23
620/70R42	356271	160	B	20.00	24.6	76.2	34.4	226	47	66	2.06	475	9900@23
620/70R42	374479	166	B	20.00	24.6	76.2	34.4	226	47	66	2.06	475	11700@35
710/70R42	003780	168	B	23.00	28.5	80.9	36.1	240	48	73	2.28	530	12300@23
710/70R42	358320	168	B	23.00	28.5	80.9	36.1	240	48	74	2.31	530	12300@23
IF710/70R42	378542	181	B	25.00	30.5	84.4	37.4	253	49	77	2.41	672	18200@35
IF710/70R42CFO	004592	179	B	25.00	29.4	80.2	35.3	240	48	74	2.31	590	17100@35
320/90R54	358339	149	B	10.00	12.4	76.7	35.8	233	47	56	1.75	215	7150@46

 Addition from previous data book

See General Farm Tire Information, Approved Rim Contours (pages 168-172) for a listing of approved rim contours by tire size. See Load & Inflation Tables (pages 92-163) for more details.

RADIAL ALL TRACTION RC — R-1W



Offers a curved-bar design that contributes to a smooth ride.

Designed with R-1W tread depth that's approximately 25% deeper in the center compared with standard R-1 tread, offering traction in a variety of soil conditions

IF- and VF-designated tires feature AD₂ technology, which helps farmers carry heavier loads at the same pressure as standard tires, or the same loads at reduced inflation pressure. This leads to reduced fuel use and reduced soil compaction.

RADIAL FARM

BIAS FARM

FRONTS & IMPLEMENTS

FORESTRY & FLOTATION

DISCONTINUED

LOAD & INFLATION TABLES

GENERAL TIRE INFORMATION

WARRANTY

TIRE DIMENSIONS (IN.)												CONTACT AREA	
TIRE SIZE	MATERIAL NUMBER	LOAD INDEX	SPEED SYMBOL RATING	DESIGN RIM WIDTH	OVERALL WIDTH	OVERALL DIA.	STATIC LOADED RADIUS	ROLLING CIRCUM.	ROLLING CIRCUM. INDEX	BAR HEIGHT 32NDS	BAR HEIGHT INCHES	FLAT PLATE (SQ. IN.)	MAX. LOAD & INFL. (LBS. @ PSI)
TUBELESS													
IF380/90R46	005478	168	D	13.00	15.0	72.7	33.8	219	46	59	1.84	268	12300@64
VF380/90R46	005544	173	D	13.00	15.0	72.7	33.5	219	46	59	1.84	302	14300@64
VF420/80R46	011859	175	D	13.00	16.2	72.8	33.2	218	46	57	1.78	319	15200@64
VF380/90R50	006358	175	D	13.00	14.9	76.7	35.4	231	47	59	1.84	297	15200@64
IF380/105R50	000905	177	D	13.00	15.9	80.7	37.3	244	48	59	1.84	327	16100@70
VF380/105R50	308429	179	D	13.00	16.2	80.7	37.3	244	48	59	1.84	327	17100@64

Addition from previous data book

See General Farm Tire Information, Approved Rim Contours (pages 168-172) for a listing of approved rim contours by tire size.
See Load & Inflation Tables (pages 92-163) for more details.

RADIAL 9000 — R-1W



A vibration-resistant lug design contributes to a smooth ride and improved wear.

Designed with R-1W tread depth that is approximately 25% deeper in the center compared with standard R-1 tread, offering traction in a variety of soil conditions.

TIRE SIZE	MATERIAL NUMBER	LOAD INDEX	SPEED SYMBOL RATING	TIRE DIMENSIONS (IN.)								CONTACT AREA	
				DESIGN RIM WIDTH	OVERALL WIDTH	OVERALL DIA.	STATIC LOADED RADIUS	ROLLING CIRCUM.	ROLLING CIRCUM. INDEX	BAR HEIGHT 32NDS	BAR HEIGHT INCHES	FLAT PLATE (SQ. IN.)	MAX. LOAD & INFL. (LBS. @ PSI)
TUBELESS													
480/85R24	365673	140	B	15.00	18.7	49.6	22.2	148	38	51	1.59	230	5520@35
320/85R34	359238	133	B	10.00	12.4	55.4	25.7	167	41	51	1.59	160	4540@35
480/70R34	003779	155	B	15.00	18.8	62.2	28.2	186	43	60	1.88	300	8550@46
480/70R34	361763	155	B	15.00	18.8	62.2	28.2	186	43	60	1.88	300	8550@46
320/85R38	359092	143	B	10.00	12.5	59.7	27.6	180	42	51	1.59	165	6000@52
650/65R38	000403	166	D	20.00	25.9	72.8	32.8	218	46	63	1.97	390	11700@41
320/90R42	359106	139	B	10.00	12.4	65.2	30.1	196	44	52	1.63	185	5360@35
900/50R42	359394	168	B	28.00	34.4	77.0	34.3	228	47	78	2.44	600	12300@23
320/90R46	357774	148	B	10.00	12.4	69.1	32.2	208	45	54	1.69	195	6950@52
380/90R46	359939	152	B	12.00	15.1	72.9	33.7	219	46	57	1.78	260	7850@41
380/90R46	007435	159	B	13.00	15.5	72.8	33.8	219	46	57	1.78	240	9650@58
320/90R50	358118	148	B	10.00	12.4	73.1	34.2	220	46	54	1.69	205	6950@46
380/90R50	362050	151	B	12.00	14.9	76.8	35.6	231	47	57	1.78	270	7600@35
380/90R54	362069	152	B	12.00	15.0	80.8	37.7	243	48	57	1.78	275	7850@35

 Addition from previous data book

See General Farm Tire Information, Approved Rim Contours (pages 168-172) for a listing of approved rim contours by tire size.
See Load & Inflation Tables (pages 92-163) for more details.

RADIAL 8000 UTILITY — R-1W



The lug and tread design contribute to traction performance in the field and handling on the road.

Engineered with damping characteristics that lead to a comfortable ride without vibration and road noise.

Manufactured with tread compounds for durability.

The tread design offers even distribution, leading to uniform wear, which helps contribute to a longer life.

RADIAL FARM

BIAS FARM

FRONTS & IMPLEMENTS

FORESTRY & FLOTATION

DISCONTINUED

LOAD & INFLATION TABLES

GENERAL TIRE INFORMATION

WARRANTY

TIRE DIMENSIONS (IN.)												CONTACT AREA	MAX. LOAD & INFL. (LBS. @ PSI)
TIRE SIZE	MATERIAL NUMBER	LOAD INDEX	SPEED SYMBOL RATING	DESIGN RIM WIDTH	OVERALL WIDTH	OVERALL DIA.	STATIC LOADED RADIUS	ROLLING CIRCUM.	ROLLING CIRCUM. INDEX	BAR HEIGHT 32NDS	BAR HEIGHT INCHES	FLAT PLATE (SQ. IN.)	
TUBELESS													
400/70R24	009314	158	A8	13.00	15.9	46.5	20.9	140	-	44	1.38	-	9350@73
480/80R34	002106	156	A8	13.00	15.9	50.2	22.5	151	-	45	1.41	-	8800@58

PERFORMER 95 — R-1W



Offers a dual-angle lug design that contributes to an increase in lug traction.

Features an increased crown radius that creates a larger footprint, leading to less soil compaction and uniform tread wear.

Designed with R-1W tread depth that's approximately 25% deeper in the center compared with standard R-1 tread, offering traction in a variety of soil conditions.

TIRE DIMENSIONS (IN.)												CONTACT AREA	MAX. LOAD & INFL. (LBS. @ PSI)
TIRE SIZE	MATERIAL NUMBER	LOAD INDEX	SPEED SYMBOL RATING	DESIGN RIM WIDTH	OVERALL WIDTH	OVERALL DIA.	STATIC LOADED RADIUS	ROLLING CIRCUM.	ROLLING CIRCUM. INDEX	BAR HEIGHT 32NDS	BAR HEIGHT INCHES	FLAT PLATE (SQ. IN.)	
TUBELESS													
230/95R32	008801	128	D	8.00	8.7	49.4	23.3	152	-	34	1.06	-	3960@58
230/95R36	011481	130	D	8.00	9.3	53.2	25.2	164	40	35	1.09	-	4180@58
230/95R44	008802	134	D	8.00	9.2	61.3	29.0	189	43	35	1.09	-	4680@58
230/85R48	006361	136	D	8.00	9.4	65.2	30.9	201	44	35	1.09	-	4940@58
270/95R48	011475	144	D	9.00	10.8	68.2	32.2	210	45	41	1.28	-	6150@58

See General Farm Tire Information, Approved Rim Contours (pages 168-172) for a listing of approved rim contours by tire size.
See Load & Inflation Tables (pages 92-163) for more details.

PERFORMER 85 — R-1W



Offers a dual-angle lug design that contributes to an increase in lug traction.

Features an increased crown radius that creates a larger footprint, leading to less soil compaction and uniform tread wear.

Designed with R-1W tread depth that's approximately 25% deeper in the center compared with standard R-1 tread, offering traction in a variety of soil conditions.

TIRE SIZE	MATERIAL NUMBER	LOAD INDEX	SPEED SYMBOL RATING	TIRE DIMENSIONS (IN.)								CONTACT AREA	
				DESIGN RIM WIDTH	OVERALL WIDTH	OVERALL DIA.	STATIC LOADED RADIUS	ROLLING CIRCUM.	ROLLING CIRCUM. INDEX	BAR HEIGHT 32NDS	BAR HEIGHT INCHES	FLAT PLATE (SQ. IN.)	MAX. LOAD & INFL. (LBS. @ PSI)
TUBELESS													
280/85R24	000565	115	D	10.00	11.5	42.8	19.3	129	36	42	1.31	-	2680@23
320/85R24	000566	122	D	11.00	12.9	45.6	20.3	137	37	45	1.41	150	3300@23
340/85R24	000567	125	D	12.00	14.1	47.0	21.2	142	38	50	1.56	165	3640@23
380/85R24	000549	131	D	13.00	15.4	49.4	22.2	149	38	54	1.69	-	4300@23
420/85R24	000599	137	D	15.00	17.2	52.1	23.4	157	40	55	1.72	-	5080@23
320/85R28	000588	124	D	10.00	13.0	49.4	22.2	150	38	48	1.50	-	3520@23
380/85R28	000589	133	D	13.00	15.6	53.5	24.1	162	40	52	1.63	-	4540@23
420/85R28	000600	139	D	15.00	17.2	56.1	25.2	170	41	60	1.88	230	5360@23
380/85R30	000401	135	D	13.00	15.4	55.4	25.0	167	41	54	1.69	-	4800@23
420/85R30	000568	140	D	15.00	17.2	58.1	26.2	175	42	55	1.72	-	5520@23
460/85R30	000569	145	D	16.00	18.7	60.8	27.3	183	42	63	1.97	-	6400@23
420/85R34	004241	142	D	15.00	17.8	61.7	27.7	187	43	57	1.78	-	5480@23
460/85R34	000586	147	D	16.00	18.7	64.8	29.2	196	44	63	1.97	-	6800@23
320/85R36	011480	128	D	10.00	12.6	57.6	25.8	174	-	52	1.63	-	3960@23
460/85R38	000587	149	D	16.00	19.3	69.3	31.2	210	45	63	1.97	-	7150@23
520/85R38	000602	155	D	18.00	21.1	72.8	32.8	220	46	71	2.22	410	8550@23
460/85R42	382078	150	D	16.00	18.8	72.8	32.8	220	46	63	1.97	-	7400@23
520/85R42	000628	157	D	18.00	21.1	76.8	34.5	232	47	69	2.16	440	9100@23

 Addition from previous data book

See General Farm Tire Information, Approved Rim Contours (pages 168-172) for a listing of approved rim contours by tire size.
See Load & Inflation Tables (pages 92-163) for more details.

PERFORMER 70 — R-1W



Rated for 40 MPH (D).

Delivers a smooth ride with a flexible sidewall.

Helps improve traction through a dual-angle tread design.

Designed with R-1W tread depth that's approximately 25% deeper in the center compared with standard R-1 tread, offering traction in a variety of soil conditions.

RADIAL FARM

BIAS FARM

FRONTS & IMPLEMENTS

FORESTRY & FLOTATION

DISCONTINUED

LOAD & INFLATION TABLES

GENERAL TIRE INFORMATION

WARRANTY

TIRE DIMENSIONS (IN.)												CONTACT AREA	MAX. LOAD & INFL. (LBS. @ PSI)
TIRE SIZE	MATERIAL NUMBER	LOAD INDEX	SPEED SYMBOL RATING	DESIGN RIM WIDTH	OVERALL WIDTH	OVERALL DIA.	STATIC LOADED RADIUS	ROLLING CIRCUM.	ROLLING CIRCUM. INDEX	BAR HEIGHT 32NDS	BAR HEIGHT INCHES	FLAT PLATE (SQ. IN.)	
TUBELESS													
380/70R24	379341	125	D	12.00	15.4	46.9	21.0	141	37	50	1.56	-	3640@23
420/70R24	379188	130	D	13.00	16.9	48.8	21.9	148	38	52	1.63	165	4180@23
480/70R24	381551	138	D	15.00	18.9	51.8	23.3	156	39	59	1.84	-	5200@23
360/70R28	382120	125	D	11.00	14.1	49.3	22.1	149	38	50	1.56	-	3640@23
380/70R28	000627	127	D	12.00	14.9	50.9	23.0	160	40	50	1.56	-	3640@23
420/70R28	004088	133	D	13.00	16.7	52.7	23.7	160	40	42	1.31	-	4540@23
480/70R28	004090	140	D	15.00	19.0	56.5	25.5	171	41	58	1.81	-	5520@23
480/70R30	002062	141	D	15.00	18.9	58.2	26.2	176	42	60	1.88	-	5680@23
480/70R34	379324	143	D	15.00	18.9	62.2	28.1	188	43	60	1.88	310	6000@23
520/70R34	003516	148	D	16.00	20.3	64.6	29.0	195	44	63	1.97	-	6945@23
480/70R38	379358	145	D	15.00	18.9	66.2	29.8	200	44	60	1.88	-	6400@23
520/70R38	379919	150	D	16.00	20.7	69.1	31.2	209	45	61	1.91	310	7400@23
580/70R38	002063	155	D	18.00	22.9	72.2	32.4	218	46	68	2.13	-	8550@23
580/70R42	006558	158	D	18.00	22.7	74.8	33.7	227	-	68	2.13	-	9350@23

☐ Addition from previous data book

See General Farm Tire Information, Approved Rim Contours (pages 168-172) for a listing of approved rim contours by tire size.
See Load & Inflation Tables (pages 92-163) for more details.

PERFORMER 65 — R-1W



Rated for 40 MPH (D).

Delivers a smooth ride with a flexible sidewall.

Helps improve traction through a dual-angle tread design.

Designed with R-1W tread depth that's approximately 25% deeper in the center compared with standard R-1 tread, offering traction in a variety of soil conditions.

TIRE SIZE	MATERIAL NUMBER	LOAD INDEX	SPEED SYMBOL RATING	TIRE DIMENSIONS (IN.)								CONTACT AREA	
				DESIGN RIM WIDTH	OVERALL WIDTH	OVERALL DIA.	STATIC LOADED RADIUS	ROLLING CIRCUM.	ROLLING CIRCUM. INDEX	BAR HEIGHT 32NDS	BAR HEIGHT INCHES	FLAT PLATE (SQ. IN.)	MAX. LOAD & INFL. (LBS. @ PSI)
TUBELESS													
480/65R28	003014	136	D	15.00	19.1	53.4	24.1	161	41	50	1.56	-	4940@23
540/65R28	003329	142	D	16.00	21.1	56.7	25.4	168	41	55	1.72	-	5840@23
540/65R30	000584	150	D	16.00	20.7	58.0	26.0	173	42	69	2.16	310	6765@35
540/65R34	000546	152	D	16.00	20.9	62.4	28.0	183	43	69	2.16	315	7850@35

RADIAL FARM

BIAS FARM

FRONTS & IMPLEMENTS

FORESTRY & FLOTATION

DISCONTINUED

LOAD & INFLATION TABLES

GENERAL TIRE INFORMATION

WARRANTY

 Addition from previous data book

See General Farm Tire Information, Approved Rim Contours (pages 168-172) for a listing of approved rim contours by tire size. See Load & Inflation Tables (pages 92-163) for more details.

PERFORMER EVO — R-1W



Reduced inflation pressure for improved soil compaction over bias.

Designed with R-1W tread depth that's approximately 25% deeper in the center compared with standard R-1 tread, offering traction in a variety of soil conditions.

6-year limited warranty¹.

RADIAL FARM

BIAS FARM

FRONTS & IMPLEMENTS

FORESTRY & FLOTATION

DISCONTINUED

LOAD & INFLATION TABLES

GENERAL TIRE INFORMATION

WARRANTY

TIRE DIMENSIONS (IN.)												CONTACT AREA	MAX. LOAD & INFL. (LBS. @ PSI)
TIRE SIZE	MATERIAL NUMBER	LOAD INDEX	SPEED SYMBOL RATING	DESIGN RIM WIDTH	OVERALL WIDTH	OVERALL DIA.	STATIC LOADED RADIUS	ROLLING CIRCUM.	ROLLING CIRCUM. INDEX	BAR HEIGHT 32NDS	BAR HEIGHT INCHES	FLAT PLATE (SQ. IN.)	
TUBELESS													
380/85R24	003167	131	D	12.00	15.3	49.2	21.8	147	-	59	1.84	195	4300@23
340/85R28	006353	127	D	11.00	13.5	50.5	22.8	151	39	60	1.88	178	3860@23
380/85R28	003152	133	D	12.00	15.3	53.2	23.8	159	40	62	1.94	211	4540@23
420/85R28	007475	139	D	13.00	17.0	55.8	25.0	171	41	65	2.03	258	5360@23
380/85R30	007121	135	D	12.00	15.3	55.5	25.0	166	41	59	1.84	208	4800@23
420/85R30	007122	140	D	13.00	16.8	58.2	25.9	174	-	65	2.03	261	5520@23
420/90R30	008859	145	D	13.00	16.7	59.6	26.6	178	42	67	2.09	263	6400@29
460/85R30	007120	145	D	15.00	18.3	60.5	27.0	181	-	67	2.09	294	6400@23
380/85R34	007483	137	D	12.00	15.1	59.1	27.0	177	42	59	1.84	246	5080@23
420/85R34	006349	142	D	13.00	16.8	61.9	28.0	185	43	65	2.03	291	5840@23
460/85R34	003168	150	D	15.00	18.3	64.5	29.3	193	-	67	2.09	320	7400@29
400/75R38	003156	138	D	13.00	15.5	61.7	28.2	186	43	60	1.88	252	5200@23
420/85R38	005285	144	D	13.00	16.8	65.9	29.8	198	44	65	2.03	314	6150@23
460/85R38	003158	149	D	15.00	18.3	68.5	30.7	205	45	67	2.09	345	7150@23

¹Certain restrictions and limitations apply. See FirestoneAg.com for details.

Addition from previous data book
See General Farm Tire Information, Approved Rim Contours (pages 168-172) for a listing of approved rim contours by tire size.
See Load & Inflation Tables (pages 92-163) for more details.

PERFORMER EVO 23° — R-1W



Reduced inflation pressure for improved soil compaction over bias.

Designed with R-1W tread depth that's approximately 25% deeper in the center compared with standard R-1 tread, offering traction in a variety of soil conditions.

With Firestone's innovative 23° tread design, more of the bar grips the surface, making it ideal for farmers looking for increased traction while more efficiently transferring horsepower to the ground, saving both time and fuel¹.

TIRE SIZE	MATERIAL NUMBER	LOAD INDEX	SPEED SYMBOL RATING	TIRE DIMENSIONS (IN.)								CONTACT AREA	
				DESIGN RIM WIDTH	OVERALL WIDTH	OVERALL DIA.	STATIC LOADED RADIUS	ROLLING CIRCUM.	ROLLING CIRCUM. INDEX	BAR HEIGHT 32NDS	BAR HEIGHT INCHES	FLAT PLATE (SQ. IN.)	MAX. LOAD & INFL. (LBS. @ PSI)
TUBELESS													
480/80R42	009132	156	D	15.00	15.3	72.7	33.2	218	46	57	1.78	337	8800@35
480/80R46	09133	158	D	15.00	13.5	76.2	34.7	229	47	57	1.78	359	9350@35

RADIAL 4000 — R-1W



A reinforced sidewall helps provide lateral stability.

The flat tread contour and wide tread arc minimizes soil compaction and rutting, and an optimized lug design and tread compound offer uniform tread wear.

A 60° lug angle at center and reinforced construction help provide straight-driving stability and steering accuracy.

TIRE SIZE	MATERIAL NUMBER	LOAD INDEX	SPEED SYMBOL RATING	TIRE DIMENSIONS (IN.)								CONTACT AREA	
				DESIGN RIM WIDTH	OVERALL WIDTH	OVERALL DIA.	STATIC LOADED RADIUS	ROLLING CIRCUM.	ROLLING CIRCUM. INDEX	BAR HEIGHT 32NDS	BAR HEIGHT INCHES	FLAT PLATE (SQ. IN.)	MAX. LOAD & INFL. (LBS. @ PSI)
TUBELESS													
280/70R18	365027	114	B	9.00	10.8	33.7	15.2	102	31	38	1.19	-	2600@35
360/70R20	008545	129	A8	11.00	14.1	41.9	18.8	127	-	48	1.5	-	4080@35

¹ Compared to 45° tread pattern design



Addition from previous data book

See General Farm Tire Information, Approved Rim Contours (pages 168-172) for a listing of approved rim contours by tire size.

See Load & Inflation Tables (pages 92-163) for more details.

RADIAL FARM

BIAS FARM

FRONTS & IMPLEMENTS

FORESTRY & FLOTATION

DISCONTINUED

LOAD & INFLATION TABLES

GENERAL TIRE INFORMATION

WARRANTY

RADIAL ALL TRACTION 23° — R-1



With Firestone's innovative 23° tread design, more of the bar grips the surface, making it ideal for farmers looking for increased traction while more efficiently transferring horsepower to the ground, saving both time and fuel¹.

Offering a wide selection of tires with AD₂ technology – delivering more traction, a better ride, and reduced soil compaction.

RADIAL FARM

BIAS FARM

FRONTS & IMPLEMENTS

FORESTRY & FLOTATION

DISCONTINUED

LOAD & INFLATION TABLES

GENERAL TIRE INFORMATION

WARRANTY

TIRE DIMENSIONS (IN.)												CONTACT AREA	MAX. LOAD & INFL. (LBS. @ PSI)
TIRE SIZE	MATERIAL NUMBER	LOAD INDEX	SPEED SYMBOL RATING	DESIGN RIM WIDTH	OVERALL WIDTH	OVERALL DIA.	STATIC LOADED RADIUS	ROLLING CIRCUM.	ROLLING CIRCUM. INDEX	BAR HEIGHT 32NDS	BAR HEIGHT INCHES	FLAT PLATE (SQ. IN.)	
TUBELESS													
23.1R26	379375	166	B	20.00	24.0	63.3	28.5	188	43	53	1.66	292	11700@46
24.5R32	352926	154	B	21.00	24.5	71.0	30.8	209	45	53	1.66	440	8250@18
30.5LR32	356204	170	B	27.00	30.5	71.6	31.0	211	45	55	1.72	500	13200@30
900/60R32	362800	176	B	27.00	34.3	75.4	33.2	226	46	61	1.91	604	15700@35
IF900/60R32CFO	000903	182	B	30.00	36.8	74.6	32.9	226	46	61	1.91	625	18700@35
IF900/60R32CFO	003149	188	B	30.00	37.0	75.6	33.5	226	46	61	1.91	671	22000@46
480/80R38	362341	149	B	16.00	18.8	69.1	30.8	206	45	50	1.56	340	7150@23
520/85R38	362375	155	B	18.00	21.2	72.2	32.0	214	46	52	1.63	390	8550@23
480/80R42	362324	151	B	16.00	18.8	73.0	32.8	218	46	50	1.56	350	7600@23
480/80R42	364092	154	B	16.00	18.8	73.0	32.8	218	46	50	1.56	350	8250@29
520/85R42	362358	157	B	18.00	21.2	76.2	34.3	228	47	52	1.63	420	9100@23
IF520/85R42CFO	000560	169	B	18.00	22.0	76.5	34.4	228	47	52	1.63	430	12800@35
14.9R46	343323	145	B	13.00	15.0	71.8	53.1	220	46	47	1.47	240	6400@36
420/80R46	352829	151	B	13.00	16.3	73.2	33.7	220	46	49	1.53	300	7600@35
IF420/80R46	000558	167	B	13.00	15.8	72.3	33.2	218	46	49	1.53	303	1200@58
480/80R46	362273	158	B	16.00	18.7	77.1	34.8	231	47	50	1.56	365	9350@35

¹ Compared to 45° tread pattern design

Addition from previous data book

See General Farm Tire Information, Approved Rim Contours (pages 168-172) for a listing of approved rim contours by tire size.

See Load & Inflation Tables (pages 92-163) for more details.

RADIAL ALL TRACTION FWD — R-1



Designed specifically for MFWD tractors, the multi-angle bar design helps improve traction with a lower angle at the shoulder area and deliver long wear with a higher angle at the nose.

TIRE DIMENSIONS (IN.)												CONTACT AREA	MAX. LOAD & INFL. (LBS. @ PSI)
TIRE SIZE	MATERIAL NUMBER	LOAD INDEX	SPEED SYMBOL RATING	DESIGN RIM WIDTH	OVERALL WIDTH	OVERALL DIA.	STATIC LOADED RADIUS	ROLLING CIRCUM.	ROLLING CIRCUM. INDEX	BAR HEIGHT 32NDS	BAR HEIGHT INCHES	FLAT PLATE (SQ. IN.)	
TUBELESS													
420/85R26	362528	138	B	15.00	17.3	54.5	24.6	161	40	49	1.53	220	5200@23
18.4R26	340421	140	B	16.00	18.8	57.1	25.6	168	41	50	1.56	260	5520@24
380/85R26	008852	132	B	12.00	15.2	51.8	23.1	155	-	47	1.47	216	4400@23
420/85R26	340405	134	B	15.00	17.3	52.5	23.6	154	39	49	1.53	215	4680@24
340/85R28	362545	127	B	12.00	13.9	51.6	23.6	154	39	46	1.43	150	3860@23
380/85R28	362562	133	B	13.00	15.3	53.8	24.5	161	40	47	1.47	180	4540@23
420/85R28	362579	139	B	15.00	17.3	56.5	25.6	167	41	49	1.53	230	5360@23
380/85R30	362596	135	B	13.00	15.3	55.8	25.5	167	41	47	1.47	190	4800@23
420/90R30	362613	142	B	15.00	17.3	58.5	26.6	172	42	49	1.53	240	5840@23
380/85R34	362630	137	B	13.00	15.4	59.8	27.3	179	42	47	1.47	210	5080@23
380/85R34	372286	137	B	13.00	15.4	59.8	27.3	179	42	47	1.47	210	5080@23
380/85R34	379290	145	B	13.00	15.4	59.8	27.3	179	42	47	1.47	210	6400@41



Addition from previous data book

See General Farm Tire Information, Approved Rim Contours (pages 168-172) for a listing of approved rim contours by tire size.

See Load & Inflation Tables (pages 92-163) for more details.

RADIAL 9100 — R-1



Designed specifically for high-load sprayer applications, the R-1 tread depth helps traction performance.

The R-1 tread bar is wider than standard, for better wear and resistance to irregular wear.

RADIAL FARM

BIAS FARM

FRONTS & IMPLEMENTS

FORESTRY & FLOTATION

DISCONTINUED

LOAD & INFLATION TABLES

GENERAL TIRE INFORMATION

WARRANTY

TIRE SIZE	MATERIAL NUMBER	LOAD INDEX	SPEED SYMBOL RATING	TIRE DIMENSIONS (IN.)								CONTACT AREA	
				DESIGN RIM WIDTH	OVERALL WIDTH	OVERALL DIA.	STATIC LOADED RADIUS	ROLLING CIRCUM.	ROLLING CIRCUM. INDEX	BAR HEIGHT 32NDS	BAR HEIGHT INCHES	FLAT PLATE (SQ. IN.)	MAX. LOAD & INFL. (LBS. @ PSI)
TUBELESS													
380/105R50	362919	168	B	12.00	16.4	80.8	37.5	244	48	49	1.53	297	12300@64

RADIAL 23° — R-1



High-angle stabilizer belts determine the size and shape of the footprint, and an open-center tread design aids in maximizing traction and enhancing cleanability.

With Firestone's innovative 23° tread design, more of the bar grips the surface, making it ideal for farmers looking for increased traction while more efficiently transferring horsepower to the ground, saving both time and fuel¹.

TIRE SIZE	MATERIAL NUMBER	LOAD INDEX	SPEED SYMBOL RATING	TIRE DIMENSIONS (IN.)								CONTACT AREA	
				DESIGN RIM WIDTH	OVERALL WIDTH	OVERALL DIA.	STATIC LOADED RADIUS	ROLLING CIRCUM.	ROLLING CIRCUM. INDEX	BAR HEIGHT 32NDS	BAR HEIGHT INCHES	FLAT PLATE (SQ. IN.)	MAX. LOAD & INFL. (LBS. @ PSI)
TUBELESS													
15.5R38	354767	125	B	14.00	15.8	61.8	28.2	184	43	45	1.41	210	3640@18
20.8R38	362204	153	B	18.00	21.2	72.2	32.1	214	46	50	1.56	375	8050@24
20.8R42	355399	155	B	18.00	21.2	76.2	34.0	228	47	50	1.56	400	8550@24

¹ Compared to 45° tread pattern design

Addition from previous data book
See General Farm Tire Information, Approved Rim Contours (pages 168-172) for a listing of approved rim contours by tire size.
See Load & Inflation Tables (pages 92-163) for more details.

RADIAL CHAMPION SPADE GRIP — R-2

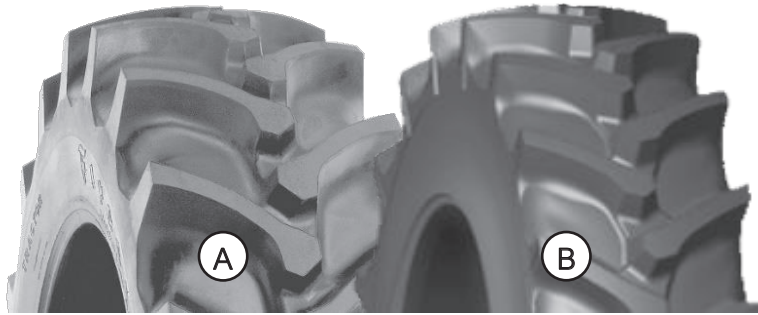

Deep tread gives better traction in wet to muddy soils.

Developed with tread and sidewall rubber compounds to help fight off weather cracking and ozone degradation.

A Firestone radial that offers longer life, better traction, and improved fuel economy over standard bias tires.

TIRE DIMENSIONS (IN.)												CONTACT AREA	MAX. LOAD & INFL. (LBS. @ PSI)	
TIRE SIZE	MATERIAL NUMBER	LOAD INDEX	SPEED SYMBOL RATING	DESIGN RIM WIDTH	OVERALL WIDTH	OVERALL DIA.	STATIC LOADED RADIUS	ROLLING CIRCUM.	ROLLING CIRCUM. INDEX	BAR HEIGHT 32NDS	BAR HEIGHT INCHES	FLAT PLATE (SQ. IN.)		
TUBELESS														
B	VF750/65R26CFO	003150	177	B	25.00	29.1	65.3	27.7	190	-	109	3.41	606	16100@35
A	16.9R28	352527	136	A8	15.00	17.1	58.2	26.1	172	-	94	2.94	220	4940@24
B	900/65R32	375992	178	A8	30.00	35.7	80.3	37.2	236	-	123	3.84	721	16500@35
B	480/70R34	369668	146	A8	15.00	18.5	62.0	28.2	186	-	97	3.03	310	6600@29
A	20.8R38	353167	153	A8	18.00	21.0	73.2	32.7	216	-	105	3.28	350	8050@24
B	IF380/80R38	006364	149	B	12.00	14.7	63.5	28.7	190	-	93	2.91	273	7150@35
A	520/85R42	371198	157	B	18.00	20.8	78.3	35.2	232	-	105	3.28	375	9100@23
A	520/85R42	371215	165	A8	18.00	20.8	78.3	35.2	232	-	105	3.28	375	11400@41
A	IF520/85R42CFO	003170	169	B	18.00	22.5	77.4	34.9	230	-	105	3.28	470	12800@35
A	320/90R46	363004	148	B	10.00	12.4	69.2	32.4	208	-	82	2.56	160	6950@52
B	520/85R46	369651	158	A8	16.00	20.3	82.9	37.8	245	-	106	3.31	525	9350@23
B	480/80R50	006363	159	B	15.00	18.5	81.7	37.6	245	-	101	3.16	413	9650@35

 Addition from previous data book

See General Farm Tire Information, Approved Rim Contours (pages 168-172) for a listing of approved rim contours by tire size.
See Load & Inflation Tables (pages 92-163) for more details.

RADIAL ALL NON-SKID (ANS) — R-3



RADIAL FARM

BIAS FARM

FRONTS & IMPLEMENTS

FORESTRY & FLOTATION

DISCONTINUED

LOAD & INFLATION TABLES

GENERAL TIRE INFORMATION

WARRANTY



Cyclical Field Operation (CFO) is engineered specifically for the significant load fluctuations that are unique to harvest.

Button-pattern design minimized soil disturbance in relation to traditional lug pattern

IF- and VF-designated tires feature AD₂ technology, which helps farmers carry heavier loads at the same pressure as standard tires, or the same loads at reduced inflation pressure. This leads to reduced fuel use and reduced soil compaction.

TIRE SIZE	MATERIAL NUMBER	LOAD INDEX	SPEED SYMBOL RATING	TIRE DIMENSIONS (IN.)								CONTACT AREA	
				DESIGN RIM WIDTH	OVERALL WIDTH	OVERALL DIA.	STATIC LOADED RADIUS	ROLLING CIRCUM.	ROLLING CIRCUM. INDEX	BAR HEIGHT 32NDS	BAR HEIGHT INCHES	FLAT PLATE (SQ. IN.)	MAX. LOAD & INFL. (LBS. @ PSI)
TUBELESS													
IF800/60R32CFO	000911	181	B	27.00	33.1	69.6	30.7	210	45	37	1.16	477	18200@46
IF900/65R32CFO	000419	191	B	31.00	37.1	78.1	34.2	232	48	40	1.25	643	24000@46

Addition from previous data book

See General Farm Tire Information, Approved Rim Contours (pages 168-172) for a listing of approved rim contours by tire size.
See Load & Inflation Tables (pages 92-163) for more details.

SUPER ALL TRACTION 23° — R-1



With Firestone's innovative 23° tread design, more of the bar grips the surface, making it ideal for farmers looking for increased traction while more efficiently transferring horsepower to the ground, saving both time and fuel¹.

An open-center tread improves cleanability, with lugs positioned and designed to resist vibration.

Sidewall rubber compounds are engineered to be both flexible and tough to offer a great ride and long wear.

TIRE DIMENSIONS (IN.)												CONTACT AREA	MAX. LOAD & INFL. (LBS. @ PSI)
TIRE SIZE	MATERIAL NUMBER	PLY RATING	SPEED SYMBOL RATING	DESIGN RIM WIDTH	OVERALL WIDTH	OVERALL DIA.	STATIC LOADED RADIUS	ROLLING CIRCUM.	ROLLING CIRCUM. INDEX	BAR HEIGHT 32NDS	BAR HEIGHT INCHES	FLAT PLATE (SQ. IN.)	
TUBELESS													
23.1-26	344095	8	A8	20.00	23.3	63.0	28.3	186	-	53	1.66	370	5680@16
28L-26	344060	12	A8	25.00	28.1	63.6	28.7	188	-	57	1.78	415	7400@20
23.1-26	362460	14	A8	20.00	23.3	63.0	28.3	186	-	53	1.66	370	7850@28
24.5-32	344079	12	A8	21.00	24.4	71.9	31.8	210	-	53	1.66	430	8800@24
30.5L-32	351075	16	A8	27.00	30.1	71.6	32.0	212	-	54	1.69	450	11000@26
23.1-34	008599	8	A8	20.00	23.8	71.8	32.0	213	-	53	1.66	420	6400@16
20.8-38	343609	8	A8	18.00	22.0	72.1	32.4	212	-	52	1.63	380	6150@18
TUBE TYPE													
18.4-34	343560	8	A8	16.00	19.3	65.4	29.1	190	-	50	1.56	300	5080@20
20.8-34	343579	8	A8	18.00	22.0	68.6	31.1	203	-	52	1.63	350	5840@18
16.9-38	343587	8	A8	15.00	17.3	66.8	30.6	199	-	49	1.53	255	4940@24
18.4-38	343595	8	A8	16.00	19.3	69.1	30.9	206	-	50	1.56	320	5360@20

¹ Compared to 45° tread pattern design

 Addition from previous data book
 See General Farm Tire Information, Approved Rim Contours (pages 168-172) for a listing of approved rim contours by tire size.
 See Load & Inflation Tables (pages 92-163) for more details.

SUPER ALL TRACTION FWD — R-1



Designed specifically for front positions of MFWD tractors, delivering a smooth ride with less vibration.

Engineered with a multi-angle bar design, including a lower angle at the shoulder to help improve traction.

Delivers long wear with a higher angle at the nose.

RADIAL FARM

BIAS FARM

FRONTS & IMPLEMENTS

FORESTRY & FLOTATION

DISCONTINUED

LOAD & INFLATION TABLES

GENERAL TIRE INFORMATION

WARRANTY

TIRE DIMENSIONS (IN.)												CONTACT AREA	
TIRE SIZE	MATERIAL NUMBER	PLY RATING	SPEED SYMBOL RATING	DESIGN RIM WIDTH	OVERALL WIDTH	OVERALL DIA.	STATIC LOADED RADIUS	ROLLING CIRCUM.	ROLLING CIRCUM. INDEX	BAR HEIGHT 32NDS	BAR HEIGHT INCHES	FLAT PLATE (SQ. IN.)	MAX. LOAD & INFL. (LBS. @ PSI)
TUBELESS													
18.4-26	343846	6	A8	16.00	18.8	57.6	25.9	169	-	50	1.56	250	3960@16
18.4-26	343919	10	A8	16.00	18.8	57.6	25.9	169	-	50	1.56	250	5200@26
13.6-28	343927	10	A8	12.00	14.2	51.7	23.7	154	-	47	1.47	145	3740@36
16.9-28	343943	10	A8	15.00	17.3	56.4	25.9	167	-	49	1.53	225	4680@28
16.9-28	008594	10	A8	15.00	17.3	56.2	25.8	168	-	49	1.53	225	4680@28

SUPER ALL TRACTION HD — R-1



Designed for high-load cotton picker and grain cart applications.

Designed with rounded shoulders to help eliminate tread lug compression.

Strong carcass handles heavy loads.

R-1 tread depth helps deliver optimum field performance.

TIRE DIMENSIONS (IN.)												CONTACT AREA	
TIRE SIZE	MATERIAL NUMBER	LOAD INDEX	SPEED SYMBOL RATING	DESIGN RIM WIDTH	OVERALL WIDTH	OVERALL DIA.	STATIC LOADED RADIUS	ROLLING CIRCUM.	ROLLING CIRCUM. INDEX	BAR HEIGHT 32NDS	BAR HEIGHT INCHES	FLAT PLATE (SQ. IN.)	MAX. LOAD & INFL. (LBS. @ PSI)
TUBELESS													
520/85D38	363038	173	A8	18.00	20.9	73.0	33.3	214	-	46	1.44	320	14300@64

Addition from previous data book

See General Farm Tire Information, Approved Rim Contours (pages 168-172) for a listing of approved rim contours by tire size.

See Load & Inflation Tables (pages 92-163) for more details.

SUPER ALL TRACTION II 23° — R-1



A bias tire with a tread design that is ideal for maximum traction and improved ride.

With Firestone's innovative 23° tread design, more of the bar grips the surface, making it ideal for farmers looking for increased traction while more efficiently transferring horsepower to the ground, saving both time and fuel¹.

TIRE DIMENSIONS (IN.)												CONTACT AREA	MAX. LOAD & INFL. (LBS. @ PSI)
TIRE SIZE	MATERIAL NUMBER	PLY RATING	SPEED SYMBOL RATING	DESIGN RIM WIDTH	OVERALL WIDTH	OVERALL DIA.	STATIC LOADED RADIUS	ROLLING CIRCUM.	ROLLING CIRCUM. INDEX	BAR HEIGHT 32NDS	BAR HEIGHT INCHES	FLAT PLATE (SQ. IN.)	
TUBELESS													
9.5-16	376808	4	A8	8.00	9.5	33.2	15.5	99	-	39	1.22	60	1100@20
9.5-24	008564	6	A8	8.00	9.5	41.8	19.1	125	-	40	1.25	84	1870@30
11.2-24	365180	8	A8	10.00	11.2	43.4	19.8	128	-	41	1.28	103	2540@36
12.4-24	365299	4	A8	11.00	12.4	45.6	20.6	135	-	43	1.34	123	1870@16
12.4-24	008556	4	A8	11.00	12.4	45.9	20.7	137	-	43	1.34	123	1870@16
12.4-24	372541	8	A8	11.00	12.4	45.6	20.6	135	-	43	1.34	123	2830@32
13.6-24	372575	8	A8	12.00	13.6	47.6	21.5	140	-	43	1.34	141	3080@28
14.9-24	365061	6	A8	13.00	15.2	49.8	22.9	148	-	44	1.38	173	3000@20
14.9-24	008559	6	A8	13.00	15.2	50.3	23.1	150	-	44	1.38	173	3000@20
14.9-24	373238	8	A8	13.00	15.2	49.8	22.9	148	-	44	1.38	173	3520@26
14.9-24	008560	8	A8	13.00	15.2	50.5	23.2	151	-	46	1.44	173	3520@26
12.4-28	008557	6	A8	11.00	12.4	50.4	22.9	150	-	43	1.34	131	2540@24
13.6-28	008558	6	A8	12.00	13.6	52.3	23.7	156	-	44	1.38	153	2830@22
14.9-28	365078	6	A8	13.00	14.9	53.8	26.3	159	-	44	1.38	183	3200@20
14.9-28	008561	6	A8	13.00	14.9	54.4	24.5	162	-	44	1.38	183	3200@20
16.9-28	008562	6	A8	15.00	16.9	57.0	25.6	170	-	47	1.47	221	3640@18
16.9-30	008563	6	A8	15.00	16.9	59.2	26.7	176	-	47	1.47	228	3740@18
18.4-30	372626	8	A8	16.00	18.4	61.1	27.4	181	-	49	1.53	275	4800@20
18.4-34	372592	8	A8	16.00	18.4	65.1	29.4	193	-	49	1.53	291	5080@20
15.5-38	372524	8	A8	14.00	15.5	61.8	28.5	183	-	44	1.38	200	4080@26
18.4-38	372507	8	A8	16.00	18.4	69.1	31.4	205	-	50	1.56	307	5360@26
20.8-38	367237	8	A8	18.00	20.8	72.2	32.7	214	-	52	1.63	374	6150@18

¹ Compared to 45° tread pattern design

 Addition from previous data book

See General Farm Tire Information, Approved Rim Contours (pages 168-172) for a listing of approved rim contours by tire size.

See Load & Inflation Tables (pages 92-163) for more details.

TRACTION FIELD & ROAD — R-1



Dual rubber compounds – flexible sidewall and tough tread compounds – help deliver a smooth ride and long wear, plus help in resisting weather cracking.

With Firestone's innovative 23° tread design, more of the bar grips the surface, making it ideal for farmers looking for increased traction while more efficiently transferring horsepower to the ground, saving both time and fuel¹.

RADIAL FARM

BIAS FARM

FRONTS & IMPLEMENTS

FORESTRY & FLOTATION

DISCONTINUED

LOAD & INFLATION TABLES

GENERAL TIRE INFORMATION

WARRANTY

TIRE SIZE	MATERIAL NUMBER	PLY RATING	SPEED SYMBOL RATING	TIRE DIMENSIONS (IN.)								CONTACT AREA	
				DESIGN RIM WIDTH	OVERALL WIDTH	OVERALL DIA.	STATIC LOADED RADIUS	ROLLING CIRCUM.	ROLLING CIRCUM. INDEX	BAR HEIGHT 32NDS	BAR HEIGHT INCHES	FLAT PLATE (SQ. IN.)	MAX. LOAD & INFL. (LBS. @ PSI)
TUBELESS													
18.4-16.1	359564	8	A8	16.00	18.4	44.8	20.1	133	-	50	1.56	155	2910@20
12.4-24	357987	12	A8	11.00	12.4	45.8	20.8	135	-	45	1.41	119	3520@48
14.9-24	345334	6	A8	13.00	14.9	49.0	22.5	146	-	48	1.50	160	3000@20
16.9-24	359505	8	A8	15.00	16.9	52.4	23.8	155	-	49	1.53	196	4080@24
14.9-26	008570	6	A8	13.00	14.9	52.4	23.6	156	-	48	1.50	166	3080@20
16.9-26	008572	6	A8	15.00	16.9	55.3	24.7	165	-	48	1.50	206	3520@18
23.1-30	364857	12	A8	20.00	23.1	67.4	29.8	197	-	53	1.66	383	7600@24
23.1-30	008591	8	A8	20.00	23.1	67.1	29.7	199	-	53	1.66	383	6000@16
13.6-38	011866	6	A8	12.00	13.9	61.8	28.7	184	-	46	1.44	190	3300@22
14.9-38	008571	6	A8	13.00	14.9	64.9	29.9	193	-	48	1.50	200	3740@20
12.4-42	358630	10	A8	9.00	11.6	63.1	29.8	188	-	45	1.41	160	4180@40
TUBE TYPE													
12.4-16	345202	4	A8	11.00	12.4	37.6	17.1	106	-	45	1.41	90	1430@16
11.2-24	008565	6	A8	10.00	11.2	43.8	20.3	131	-	43	1.34	96	2090@26
14.9-24	008568	6	A8	13.00	14.9	49.6	22.8	148	-	48	1.50	160	3000@20
18.4-28	338494	6	A8	16.00	18.4	59.4	26.7	176	-	50	1.56	250	4080@16
13.6-38	338087	6	A8	12.00	13.6	61.5	28.4	184	-	47	1.47	168	3300@22
12.4-42	008566	6	A8	9.00	11.6	63.5	30.0	189	-	45	1.41	160	3080@24

¹ Compared to 45° tread pattern design

Addition from previous data book

See General Farm Tire Information, Approved Rim Contours (pages 168-172) for a listing of approved rim contours by tire size.

See Load & Inflation Tables (pages 92-163) for more details.



Wear- and snag-resistant tread compounds and flexible sidewall rubber combine for a great ride and long tire life.

With Firestone's innovative 23° tread design, more of the bar grips the surface, making it ideal for farmers looking for increased traction while more efficiently transferring horsepower to the ground, saving both time and fuel¹.

TIRE DIMENSIONS (IN.)												CONTACT AREA	
TIRE SIZE	MATERIAL NUMBER	PLY RATING	SPEED SYMBOL RATING	DESIGN RIM WIDTH	OVERALL WIDTH	OVERALL DIA.	STATIC LOADED RADIUS	ROLLING CIRCUM.	ROLLING CIRCUM. INDEX	BAR HEIGHT 32NDS	BAR HEIGHT INCHES	FLAT PLATE (SQ. IN.)	MAX. LOAD & INFL. (LBS. @ PSI)
TUBE TYPE													
11.2-28	361623	6	A8	10.00	11.2	47.0	21.6	142	-	37	1.16	100	2200@24
11.2-36	304808	4	A8	10.00	11.2	55.0	25.6	166	-	37	1.16	115	2040@18
11.2-38	355003	4	A8	10.00	11.2	57.0	26.6	172	-	37	1.16	120	2090@18
11.2-38	000929	6	A8	10.00	11.2	57.0	26.6	172	-	37	1.16	120	2540@26
12.4-38	304840	4	A8	11.00	12.4	59.0	27.2	178	-	39	1.22	140	2340@16
12.4-38	354805	8	A8	11.00	12.4	59.0	27.2	178	-	39	1.22	140	3520@32

RADIAL FARM

BIAS FARM

FRONTS & IMPLEMENTS

FORESTRY & FLOTATION

DISCONTINUED

LOAD & INFLATION TABLES

GENERAL TIRE INFORMATION

WARRANTY

¹ Compared to 45° tread pattern design

Addition from previous data book

See General Farm Tire Information, Approved Rim Contours (pages 168-172) for a listing of approved rim contours by tire size.

See Load & Inflation Tables (pages 92-163) for more details.

CHAMPION HYDRO ND — R-1



Ideal for linear and pivot irrigation systems.

Designed with non-directional tread pattern that equalizes traction in forward and reverse direction.

Delivers traction in consistently wet and dry conditions.

The 0° bar angle offers better cleanability and less slippage than conventional tread designs, resulting in reduced soil disturbance and less rutting.

RADIAL FARM

BIAS FARM

FRONTS & IMPLEMENTS

FORESTRY & FLOTATION

DISCONTINUED

LOAD & INFLATION TABLES

GENERAL TIRE INFORMATION

WARRANTY

TIRE DIMENSIONS (IN.)												CONTACT AREA	MAX. LOAD & INFL. (LBS. @ PSI)
TIRE SIZE	MATERIAL NUMBER	LOAD INDEX	SPEED SYMBOL RATING	DESIGN RIM WIDTH	OVERALL WIDTH	OVERALL DIA.	STATIC LOADED RADIUS	ROLLING CIRCUM.	ROLLING CIRCUM. INDEX	BAR HEIGHT 32NDS	BAR HEIGHT INCHES	FLAT PLATE (SQ. IN.)	
TUBELESS													
380/85D24	008526	145	-	12.00	15.0	49.8	21.3	149	-	47	1.47	268	6400@26
290/85D38	003147	141	CREEP	10.00	12.1	58.8	26.2	174	-	43	1.34	205	5680@37

IRRIGATION SPECIAL — R-1



Designed specifically for mobile irrigation equipment.

Engineered with tough nylon-cord body for durability and long wear and dual rubber compounds for long wear and resistance to weather cracking.

TIRE DIMENSIONS (IN.)												CONTACT AREA	MAX. LOAD & INFL. (LBS. @ PSI)
TIRE SIZE	MATERIAL NUMBER	PLY RATING	SPEED SYMBOL RATING	DESIGN RIM WIDTH	OVERALL WIDTH	OVERALL DIA.	STATIC LOADED RADIUS	ROLLING CIRCUM.	ROLLING CIRCUM. INDEX	BAR HEIGHT 32NDS	BAR HEIGHT INCHES	FLAT PLATE (SQ. IN.)	
TUBE TYPE													
11.2-24	321893	4	-	10.00	11.2	43.1	19.7	130	-	32	1.00	90	3480@24
14.9-24	322377	4	-	13.00	14.9	50.0	22.5	148	-	36	1.13	138	5060@18
14.9-24	342459	4	-	13.00	14.9	50.0	22.5	148	-	36	1.13	138	5060@18
14.9-24	000912	6	-	13.00	14.9	50.0	22.5	148	-	36	1.13	138	6330@26

Addition from previous data book
 See General Farm Tire Information, Approved Rim Contours (pages 168-172) for a listing of approved rim contours by tire size.
 See Load & Inflation Tables (pages 92-163) for more details.

CHAMPION SPADE GRIP — R-2



Buttressed tie bars and a bolstered nose combine with a tough tread rubber compound to help provide long wear performance.

The tread rubber compound resists weather cracking and checking, and, in combination with the sidewall rubber compound fights off acid and ozone.

TIRE DIMENSIONS (IN.)												CONTACT AREA	MAX. LOAD & INFL. (LBS. @ PSI)
TIRE SIZE	MATERIAL NUMBER	PLY RATING	SPEED SYMBOL RATING	DESIGN RIM WIDTH	OVERALL WIDTH	OVERALL DIA.	STATIC LOADED RADIUS	ROLLING CIRCUM.	ROLLING CIRCUM. INDEX	BAR HEIGHT 32NDS	BAR HEIGHT INCHES	FLAT PLATE (SQ. IN.)	
TUBELESS													
14.9-24	359610	12	A8	13.00	14.8	51.9	22.8	150	-	90	2.81	145	4400@38
18.4-26	326445	10	A8	16.00	18.4	57.8	26.0	168	-	100	3.13	230	5200@26
18.4-26	008598	10	A8	16.00	18.4	57.8	26.0	168	-	100	3.13	230	5200@26
23.1-26	362647	10	A8	20.00	23.1	66.5	29.8	193	-	100	3.13	300	6400@20
28L-26	379868	16	A8	25.00	28.1	65.9	29.4	192	-	109	3.41	390	9100@28
18.4-30	342432	10	A8	16.00	18.4	61.8	27.7	178	-	100	3.13	250	5520@26
18.4-30	008593	10	A8	16.00	18.4	61.2	27.5	184	-	100	3.13	250	5520@26
24.5-32	311626	10	A8	21.00	24.5	73.3	33.1	212	-	112	3.50	405	7850@20
30.5L-32	358231	14	A8	27.00	30.5	74.0	34.0	216	-	114	3.56	485	9900@22
35.5L-32	358258	12	A8	31.00	35.5	80.8	36.8	237	-	120	3.75	600	11000@16
13.6-38	008527	6	A8	25.00	13.4	62.9	29.8	189	-	86	2.69	135	3300@22
13.6-46	000917	6	A8	12.00	13.3	70.4	33.2	214	-	86	2.69	171	3640@22
13.6-46	008528	6	A8	12.00	13.3	71.0	33.5	213	-	86	2.69	171	3640@22
TUBE TYPE													
23.1-30	311189	8	A8	20.00	23.1	69.6	31.5	203	-	109	3.41	360	6000@16

 Addition from previous data book

See General Farm Tire Information, Approved Rim Contours (pages 168-172) for a listing of approved rim contours by tire size.
See Load & Inflation Tables (pages 92-163) for more details.

TURF & FIELD — R-3



Engineered with traction features and resistance to lateral sway.

Good flotation prevents chunking and cutting of turf on level and sloping areas.

RADIAL FARM

BIAS FARM

FRONTS & IMPLEMENTS

FORESTRY & FLOTATION

DISCONTINUED

LOAD & INFLATION TABLES

GENERAL TIRE INFORMATION

WARRANTY

TIRE DIMENSIONS (IN.)												CONTACT AREA	
TIRE SIZE	MATERIAL NUMBER	PLY RATING	SPEED SYMBOL RATING	DESIGN RIM WIDTH	OVERALL WIDTH	OVERALL DIA.	STATIC LOADED RADIUS	ROLLING CIRCUM.	ROLLING CIRCUM. INDEX	BAR HEIGHT 32NDS	BAR HEIGHT INCHES	FLAT PLATE (SQ. IN.)	MAX. LOAD & INFL. (LBS. @ PSI)
TUBELESS													
9.5-16	351776	6	A8	8.00	9.5	32.3	14.0	94	-	19	0.59	55	1390@30
21.5L-16.1	012720	6	A8	18.00	21.1	44.2	19.6	131	-	33	1.03	190	2760@12
21.5L-16.1	008596	10	A8	18.00	20.8	45.2	19.7	133	-	33	1.03	190	3860@22
19.5L-24	356190	10	A8	16.00	19.0	52.4	23.5	153	-	27	0.84	205	4680@24
TUBE TYPE													
13.6-16	345210	4	A8	12.00	13.5	38.5	18.0	115	-	12	0.38	91	1570@14

Addition from previous data book

See General Farm Tire Information, Approved Rim Contours (pages 168-172) for a listing of approved rim contours by tire size.
See Load & Inflation Tables (pages 92-163) for more details.

ALL NON-SKID TRACTOR — R-3



Delivers the flotation necessary for turf and other sensitive areas, with little disturbance.

A non-aggressive multi-block tread design helps ensure forward, reverse and lateral traction.

TIRE DIMENSIONS (IN.)													CONTACT AREA	MAX. LOAD & INFL. (LBS. @ PSI)
TIRE SIZE	MATERIAL NUMBER	PLY RATING	SPEED SYMBOL RATING	DESIGN RIM WIDTH	OVERALL WIDTH	OVERALL DIA.	STATIC LOADED RADIUS	ROLLING CIRCUM.	ROLLING CIRCUM. INDEX	BAR HEIGHT 32NDS	BAR HEIGHT INCHES	FLAT PLATE (SQ. IN.)		
TUBELESS														
8.3-24	351733	4	A8	7.00	8.3	38.8	18.0	116	-	18	0.56	60	1230@22	
14.9-24	351709	6	A8	13.00	14.9	49.8	22.6	147	-	23	0.72	155	3000@20	
14.9-24	008508	6	A8	13.00	14.9	49.1	22.3	145	-	23	0.72	155	3000@20	
16.9-24	008510	6	A8	15.00	16.9	51.9	23.1	151	-	28	0.88	190	3420@18	
16.9-24	358789	10	A8	15.00	16.9	51.9	23.1	151	-	28	0.88	190	4400@28	
16.9-24	011877	10	A8	15.00	17.5	51.1	23.1	151	-	28	0.88	177	4400@28	
18.4-26	315958	6	A8	16.00	19.0	56.0	25.6	167	-	29	0.91	235	3960@16	
18.4-26	369753	12	A8	16.00	19.0	56.0	25.6	167	-	29	0.91	235	5840@32	
23.1-26	345377	8	A8	20.00	23.1	59.7	26.8	176	-	21	0.66	350	5680@16	
23.1-26	323527	12	A8	20.00	23.1	59.7	26.8	176	-	21	0.66	350	7150@24	
28L-26	351008	12	A8	25.00	28.1	60.7	26.6	176	-	21	0.66	390	7400@20	
28L-26	362220	16	A8	25.00	28.1	60.7	26.6	176	-	21	0.66	390	9100@28	
24.5-32	322296	12	A8	21.00	24.7	69.1	29.7	198	-	35	1.09	390	8800@24	
24.5-32	360384	16	A8	21.00	24.7	69.1	29.7	198	-	35	1.09	390	9900@30	
30.5L-32	357758	16	A8	27.00	30.5	70.6	30.3	202	-	38	1.19	370	11000@26	
35.5L-32	357820	20	A8	31.00	36.4	78.2	33.0	224	-	39	1.22	627	15200@28	

Addition from previous data book

See General Farm Tire Information, Approved Rim Contours (pages 168-172) for a listing of approved rim contours by tire size.
See Load & Inflation Tables (pages 92-163) for more details.

ALL NON-SKID TRACTOR II — R-3



RADIAL FARM

BIAS FARM

FRONTS & IMPLEMENTS

FORESTRY & FLOTATION

DISCONTINUED

LOAD & INFLATION TABLES

GENERAL TIRE INFORMATION

WARRANTY



Design helps deliver excellent wear performance, which is ideal for large implements and combines.

Five ribs made of tough rubber buttons help deliver long wear.

Deeper tread buttons provide longer wear when compared to standard All Non-Skid (ANS) design.

TIRE DIMENSIONS (IN.)												CONTACT AREA	
TIRE SIZE	MATERIAL NUMBER	PLY RATING	SPEED SYMBOL RATING	DESIGN RIM WIDTH	OVERALL WIDTH	OVERALL DIA.	STATIC LOADED RADIUS	ROLLING CIRCUM.	ROLLING CIRCUM. INDEX	BAR HEIGHT 32NDS	BAR HEIGHT INCHES	FLAT PLATE (SQ. IN.)	MAX. LOAD & INFL. (LBS. @ PSI)
TUBELESS													
28L-26	351857	12	A8	25.00	28.1	62.6	27.9	183	-	34	1.06	440	7400@20
28L-26	362085	16	A8	25.00	28.1	62.6	27.9	183	-	34	1.06	440	9100@28

ALL TRACTION UTILITY — R-4



Built with special rubber compounds and a nylon-cord body for impact resistance and long wear.

The tread compound is designed for long tire life on hard-surface roads, and wide-buttressed lugs help improve durability and provide long-life.

TIRE DIMENSIONS (IN.)												CONTACT AREA	
TIRE SIZE	MATERIAL NUMBER	PLY RATING	SPEED SYMBOL RATING	DESIGN RIM WIDTH	OVERALL WIDTH	OVERALL DIA.	STATIC LOADED RADIUS	ROLLING CIRCUM.	ROLLING CIRCUM. INDEX	BAR HEIGHT 32NDS	BAR HEIGHT INCHES	FLAT PLATE (SQ. IN.)	MAX. LOAD & INFL. (LBS. @ PSI)
TUBELESS													
14.9-24	358584	12	A8	13.00	14.9	48.9	22.2	145	-	33	1.03	140	6400@42
16.9-24	309281	8	A8	15.00	16.9	51.9	23.0	152	-	34	1.06	185	5840@28
17.5L-24	315486	8	A8	15.00	17.5	48.9	22.2	145	-	32	1.00	192	5360@26
420/70-24	351040	6	A8	13.00	16.7	46.4	21.1	136	-	34	1.06	165	3960@26
420/70-24	008511	6	A8	13.00	16.7	45.6	20.8	136	-	34	1.06	165	3960@26

Addition from previous data book

See General Farm Tire Information, Approved Rim Contours (pages 168-172) for a listing of approved rim contours by tire size.

See Load & Inflation Tables (pages 92-163) for more details.

PULLER 2000 — P-1



RADIAL FARM

BIAS FARM

FRONTS & IMPLEMENTS

FORESTRY & FLOTATION

DISCONTINUED

LOAD & INFLATION TABLES

GENERAL TIRE INFORMATION

WARRANTY

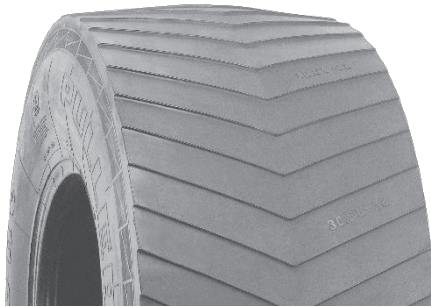

Built specifically for tractor pulling competitions, the special body construction and a specialized compound help deliver long edge wear and a stronger bite.

TIRE DIMENSIONS (IN.)												CONTACT AREA	
TIRE SIZE	MATERIAL NUMBER	PLY RATING	SPEED SYMBOL RATING	DESIGN RIM WIDTH	OVERALL WIDTH	OVERALL DIA.	STATIC LOADED RADIUS	ROLLING CIRCUM.	ROLLING CIRCUM. INDEX	BAR HEIGHT 32NDS	BAR HEIGHT INCHES	FLAT PLATE (SQ. IN.)	MAX. LOAD & INFL. (LBS. @ PSI)
TUBELESS													
24.5-32	369685	HP	-	25.00	25.8	66.8	32.0	201	-	8	0.25	350	5200@10
30.5L-32	361992	HP	-	27.00	30.5	66.8	32.0	201	-	8	0.25	420	6950@12

DURAFORCE ND — NHS



This tread design helps improve both forward and reverse traction and flotation.

A tough sidewall helps provide for greater stability.

TIRE DIMENSIONS (IN.)												CONTACT AREA	
TIRE SIZE	MATERIAL NUMBER	PLY RATING	SPEED SYMBOL RATING	DESIGN RIM WIDTH	OVERALL WIDTH	OVERALL DIA.	STATIC LOADED RADIUS	ROLLING CIRCUM.	ROLLING CIRCUM. INDEX	BAR HEIGHT 32NDS	BAR HEIGHT INCHES	FLAT PLATE (SQ. IN.)	MAX. LOAD & INFL. (LBS. @ PSI)
TUBELESS													
355/70D17.5NHS	361666	10	B	10.50	13.8	36.2	16.0	105	-	24	0.75	140	6950@70
385/65D19.5NHS	361682	12	B	11.75	15.3	40.1	18.0	119	-	25	0.78	181	8800@70
395/55D16.5NHS	360503	12	B	12.00	15.5	33.0	14.8	97	-	28	0.88	135	6835@60
445/65D22.5NHS	361720	16	B	14.00	18.0	46.2	20.7	136	-	28	0.88	217	14300@85

Addition from previous data book

See General Farm Tire Information, Approved Rim Contours (pages 168-172) for a listing of approved rim contours by tire size.

See Load & Inflation Tables (pages 92-163) for more details.

DESTINATION FARM — I-1



Carry heavier loads or run at reduced inflation pressure with AD₂ technology¹

Specially designed for the high-load demands of today's agricultural equipment.

Flatter tread profile helps manage soil compaction.

Radial design provides longer wear when compared to equivalent bias-sized implement tires.

RADIAL FARM

BIAS FARM

FRONTS & IMPLEMENTS

FORESTRY & FLOTATION

DISCONTINUED

LOAD & INFLATION TABLES

GENERAL TIRE INFORMATION

WARRANTY

TIRE SIZE	MATERIAL NUMBER	LOAD INDEX	SPEED SYMBOL RATING	TIRE DIMENSIONS (IN.)								CONTACT AREA	
				DESIGN RIM WIDTH	OVERALL WIDTH	OVERALL DIA.	STATIC LOADED RADIUS	ROLLING CIRCUM.	ROLLING CIRCUM. INDEX	BAR HEIGHT 32NDS	BAR HEIGHT INCHES	FLAT PLATE (SQ. IN.)	MAX. LOAD & INFL. (LBS. @ PSI)
TUBELESS													
IF200/90R15	008689	114	D	6.00	7.6	29.3	13.1	88	-	11	0.34	57	2600@46
IF210/75R15	005514	115	D	6.00	8.2	27.4	12.3	82	-	11	0.34	57	2680@52
IF240/80R15	000543	121	D	8.00	9.7	30.1	13.4	90	-	11	0.34	66	3200@46
IF265/85R15	001585	125	D	8.00	10.7	32.7	14.5	97	-	11	0.34	87	3640@41
IF280/70R15	004844	134	D	8.00	10.7	30.5	13.8	92	-	11	0.34	80	4680@64
IF320/65R15	007118	142	D	10.00	12.4	31.1	13.6	94	-	11	0.34	92	5840@70
IF320/70R15	003166	144	D	10.00	12.6	32.6	14.4	97	-	11	0.34	98	6150@70
VF245/70R19.5	001581	142	D	7.50	9.4	33.4	14.8	100	-	19	0.59	74	5840@75
VF265/70R19.5	000896	141	D	7.50	9.9	34.4	15.5	103	-	20	0.63	92	6600@75
VF285/70R19.5	000895	150	D	8.25	10.6	35.4	15.9	106	-	21	0.66	100	7400@75
VF295/75R22.5	001583	151	D	8.25	10.6	40.1	17.8	121	-	19	0.59	109	7600@64
VF385/65R22.5	000899	163	D	11.75	15.1	42.7	18.5	128	-	23	0.72	144	10700@70
VF445/65R22.5	001584	174	D	13.00	17.3	45.8	19.6	138	-	24	0.75	194	14800@75

¹ Compared to standard equivalent Firestone tires.

Addition from previous data book
See General Farm Tire Information, Approved Rim Contours (pages 168-172) for a listing of approved rim contours by tire size.
See Load & Inflation Tables (pages 92-163) for more details.

DESTINATION TURF — I-2



Featuring a turf pattern powered with biting edges to grip the soil while enhancing the cleaning power.

Designed with AD₂ technology, which delivers a larger, more uniform contact area and makes it possible to carry the same load at lower inflation pressure or handle higher loads at the same inflation pressure.¹

Designed with steel belts and special compounds that are engineered to be more resistant to stubble.

TIRE DIMENSIONS (IN.)												CONTACT AREA	
TIRE SIZE	MATERIAL NUMBER	LOAD INDEX	SPEED SYMBOL RATING	DESIGN RIM WIDTH	OVERALL WIDTH	OVERALL DIA.	STATIC LOADED RADIUS	ROLLING CIRCUM.	ROLLING CIRCUM. INDEX	BAR HEIGHT 32NDS	BAR HEIGHT INCHES	FLAT PLATE (SQ. IN.)	MAX. LOAD & INFL. (LBS. @ PSI)
TUBELESS													
IF320/65R15	007119	142	D	10.00	12.6	31.1	13.5	93	-	13	0.41	100	5840@70
IF320/70R15	006264	144	D	10.00	12.4	32.6	14.2	97	-	13	0.41	108	6150@70
VF445/50R22.5	007469	166	D	14.00	17.4	39.8	17.1	120	-	26	0.81	180	11700@75

RADIAL FARM

BIAS FARM

FRONTS & IMPLEMENTS

FORESTRY & FLOTATION

DISCONTINUED

LOAD & INFLATION TABLES

GENERAL TIRE INFORMATION

WARRANTY

¹ Compared to standard equivalent Firestone tires.



Addition from previous data book

See General Farm Tire Information, Approved Rim Contours (pages 168-172) for a listing of approved rim contours by tire size.

See Load & Inflation Tables (pages 92-163) for more details.

CHAMPION GUIDE GRIP 4-RIB — F-2



Designed with a self-cleaning tread.

A front tractor tire with four-rib design for hold, flotation and resistance to side-slip.

A wide selection of high-flotation/low-profile and conventional sizes.

Stubble Stomper tires are specially fortified with rubber compounds that help guard against stubble puncture and tire erosion.

RADIAL FARM

BIAS FARM

FRONTS & IMPLEMENTS

FORESTRY & FLOTATION

DISCONTINUED

LOAD & INFLATION TABLES

GENERAL TIRE INFORMATION

WARRANTY

TIRE DIMENSIONS (IN.)												CONTACT AREA	
TIRE SIZE	MATERIAL NUMBER	PLY RATING	SPEED SYMBOL RATING	DESIGN RIM WIDTH	OVERALL WIDTH	OVERALL DIA.	STATIC LOADED RADIUS	ROLLING CIRCUM.	ROLLING CIRCUM. INDEX	BAR HEIGHT 32NDS	BAR HEIGHT INCHES	FLAT PLATE (SQ. IN.)	MAX. LOAD & INFL. (LBS. @ PSI)
TUBELESS													
9.5L-15	375227	8	A8	8.00	9.4	30.6	13.9	90	-	23	0.72	42	1870@48
9.5L-15	008523	8	A8	8.00	9.4	31.2	14.1	93	-	23	0.72	42	1870@48
11L-15	376570	8	A8	8.00	10.8	32.1	14.5	95	-	27	0.84	55	2090@44
11L-15	008521	8	A8	8.00	10.8	32.2	14.5	96	-	27	.084	55	2090@44
7.50-16	374717	8	A8	5.50	8.2	31.5	14.3	92	-	20	0.63	38	1710@56
10.00-16	008519	8	A8	8.00	10.6	35.1	15.9	104	-	26	0.81	60	2340@44
11.00-16	339873	8	A8	10.00	12.2	37.8	17.1	113	-	29	0.91	71	2600@40
11.00-16	008520	8	A8	10.00	12.2	37.6	17.0	112	-	29	0.91	71	2600@40
11.00-16	342602	12	A8	10.00	12.2	37.8	17.1	113	-	29	0.91	71	3420@60
14L-16.1	359432	12	A8	11.00	13.8	38.5	17.4	114	-	33	1.03	101	3860@52
16.5L-16.1	339938	8	A8	14.00	16.3	41.7	18.9	122	-	36	1.13	135	3250@32

STUBBLE STOMPER

TUBELESS													
10.00-16	008524	8	A8	8.00	10.6	35.3	15.9	105	-	26	0.81	60	2340@44
11.00-16	008525	8	A8	10.00	12.2	37.4	16.9	111	-	29	0.91	71	2600@40

Addition from previous data book

See General Farm Tire Information, Approved Rim Contours (pages 168-172) for a listing of approved rim contours by tire size.

See Load & Inflation Tables (pages 92-163) for more details.

CHAMPION GUIDE GRIP 3-RIB — F-2



Self-cleaning three-rib tread pattern designed for positive steering and quick steering response.

A shock-fortified cord body resists snags and impacts.

Special high-density rubber compounds in Stubble Stomper line helps resist stubble damage.

TIRE DIMENSIONS (IN.)												CONTACT AREA	
TIRE SIZE	MATERIAL NUMBER	PLY RATING	SPEED SYMBOL RATING	DESIGN RIM WIDTH	OVERALL WIDTH	OVERALL DIA.	STATIC LOADED RADIUS	ROLLING CIRCUM.	ROLLING CIRCUM. INDEX	BAR HEIGHT 32NDS	BAR HEIGHT INCHES	FLAT PLATE (SQ. IN.)	MAX. LOAD & INFL. (LBS. @ PSI)
TUBELESS													
11L-15	375142	8	A8	8.00	11.3	32.2	14.6	96	-	34	1.06	53	2090@44
6.00-16	374700	6	A8	4.00	6.4	29.1	13.5	87	-	19	0.59	36	1140@52
6.50-16	374683	6	A8	4.50	7.0	30.4	14.2	88	-	22	0.69	41	1230@48
7.50-16	374751	8	A8	5.50	8.2	32.0	16.3	95	-	24	0.75	43	1710@56
10.00-16	008512	8	A8	8.00	10.8	35.5	16.3	106	-	32	1.00	60	2340@44
11.00-16	008513	8	A8	10.00	12.4	38.3	17.6	114	-	35	1.09	71	2600@40
14L-16.1	322687	10	A8	11.00	14.0	38.8	17.1	114	-	41	1.28	100	3420@44

STUBBLE STOMPER

TUBELESS													
10.00-16	357847	8	A8	8.00	10.6	35.2	16.2	103	-	32	1.00	60	2340@44
10.00-16	008616	8	A8	8.00	10.8	36.1	16.6	107	-	32	1.00	60	2340@44
11.00-16	357855	8	A8	10.00	12.4	38.1	17.5	113	-	35	1.09	71	2600@40
11.00-16	008517	8	A8	10.00	12.4	38.8	17.8	115	-	35	1.09	71	2600@40

 Addition from previous data book

See General Farm Tire Information, Approved Rim Contours (pages 168-172) for a listing of approved rim contours by tire size.

See Load & Inflation Tables (pages 92-163) for more details.

GUIDE GRIP 3-RIB — F-2



An all-purpose front tractor tire that offers a self-cleaning three-rib tread designed for positive steering and quick steering response.

A shock-fortified cord body resists snags and impacts.

Specially formulated rubber helps resist weathering.

RADIAL FARM

BIAS FARM

FRONTS & IMPLEMENTS

FORESTRY & FLOTATION

DISCONTINUED

LOAD & INFLATION TABLES

GENERAL TIRE INFORMATION

WARRANTY

TIRE DIMENSIONS (IN.)												CONTACT AREA	
TIRE SIZE	MATERIAL NUMBER	PLY RATING	SPEED SYMBOL RATING	DESIGN RIM WIDTH	OVERALL WIDTH	OVERALL DIA.	STATIC LOADED RADIUS	ROLLING CIRCUM.	ROLLING CIRCUM. INDEX	BAR HEIGHT 32NDS	BAR HEIGHT INCHES	FLAT PLATE (SQ. IN.)	MAX. LOAD & INFL. (LBS. @ PSI)
TUBELESS													
7.5L-15	374666	6	A8	6.00	8.4	29.2	13.6	89	-	19	0.59	37	1430@44

INDUSTRIAL SPECIAL — F-3



Specifically engineered for agricultural tractors in industrial service.

Helps in improving wear performance on hard soil, asphalt, and concrete.

Shock-fortified nylon-cord body resists impact, cuts and punctures.

TIRE DIMENSIONS (IN.)												CONTACT AREA	
TIRE SIZE	MATERIAL NUMBER	PLY RATING	SPEED SYMBOL RATING	DESIGN RIM WIDTH	OVERALL WIDTH	OVERALL DIA.	STATIC LOADED RADIUS	ROLLING CIRCUM.	ROLLING CIRCUM. INDEX	BAR HEIGHT 32NDS	BAR HEIGHT INCHES	FLAT PLATE (SQ. IN.)	MAX. LOAD & INFL. (LBS. @ PSI)
TUBELESS													
11L-15	316024	8	A8	8.00	11.0	30.9	14.1	92	-	14	0.44	59	2090@44
11L-15	008547	8	A8	8.00	11.0	31.3	14.3	93	-	14	0.44	59	2090@44
11L-15	326011	10	A8	8.00	11.0	30.9	14.1	92	-	14	0.44	59	2340@52

Addition from previous data book
 See General Farm Tire Information, Approved Rim Contours (pages 168-172) for a listing of approved rim contours by tire size.
 See Load & Inflation Tables (pages 92-163) for more details.

HIGHWAY SPECIAL — I-1



DOT-approved for highway speeds. Designed to accommodate intermittent highway use by farm implements and wagons in agricultural service.

Offers a five-rib design for increased stability and higher load capacity.

TIRE SIZE	MATERIAL NUMBER	LOAD RANGE	SPEED SYMBOL RATING	TIRE DIMENSIONS (IN.)								CONTACT AREA	
				DESIGN RIM WIDTH	OVERALL WIDTH	OVERALL DIA.	STATIC LOADED RADIUS	ROLLING CIRCUM.	ROLLING CIRCUM. INDEX	BAR HEIGHT 32NDS	BAR HEIGHT INCHES	FLAT PLATE (SQ. IN.)	MAX. LOAD & INFL. (LBS. @ PSI)
TUBELESS													
9.5L-15FI	374598	E	J	8.00	9.5	30.8	14.0	90	-	11	0.34	42	3080@75
9.5L-15FI	013528	E	J	8.00	10.2	30.7	13.6	98	-	11	0.34	42	3080@75
11L-15FI	374581	F	J	8.00	10.8	30.6	13.6	92	-	11	0.34	75	3960@90
12.5L-15FI	374564	F	J	10.00	12.3	32.8	14.6	98	-	11	0.34	98	4680@90

RADIAL FARM

BIAS FARM

FRONTS & IMPLEMENTS

FORESTRY & FLOTATION

DISCONTINUED

LOAD & INFLATION TABLES

GENERAL TIRE INFORMATION

WARRANTY

Addition from previous data book

See General Farm Tire Information, Approved Rim Contours (pages 168-172) for a listing of approved rim contours by tire size.
See Load & Inflation Tables (pages 92-163) for more details.

FARM IMPLEMENT — I-1



Designed for free-rolling wheels on wagons and trailers, the Farm Implement with Stubble Stomper option is designed with specially fortified rubber that stands tough against stubble punctures and tire erosion.

Cut-resistant sidewall reduces downtime.

Impact-resistant, shock-fortified nylon-cord body.

Specially formulated rubber helps resist weathering.

RADIAL FARM

BIAS FARM

FRONTS & IMPLEMENTS

FORESTRY & FLOTATION

DISCONTINUED

LOAD & INFLATION TABLES

GENERAL TIRE INFORMATION

WARRANTY

TIRE SIZE	MATERIAL NUMBER	PLY RATING	SPEED SYMBOL RATING	TIRE DIMENSIONS (IN.)								CONTACT AREA	
				DESIGN RIM WIDTH	OVERALL WIDTH	OVERALL DIA.	STATIC LOADED RADIUS	ROLLING CIRCUM.	ROLLING CIRCUM. INDEX	BAR HEIGHT 32NDS	BAR HEIGHT INCHES	FLAT PLATE (SQ. IN.)	MAX. LOAD & INFL. (LBS. @ PSI)
TUBELESS													
9.5L-14	358940	8	B	8.00	9.4	29.0	12.9	86	-	8	0.25	59	2400@44
9.5L-14	008539	8	B	8.00	9.4	29.8	13.2	88	-	8	0.25	59	2400@44
11L-14	008530	8	B	8.00	10.8	29.5	13.1	87	-	8	0.25	77	2440@36
5.90-15	339288	4	B	4.50	6.0	26.0	11.6	77	-	7	0.22	34	1140@36
6.70-15	375652	6	B	4.50	6.7	27.7	12.3	82	-	7	0.22	39	1610@44
7.60-15	339369	8	B	5.50	7.5	28.7	12.8	86	-	8	0.25	42	2090@52
27X9.50-15	008536	8	B	7.00	9.4	27.9	12.8	83	-	10	0.31	53	1870@60
7.60-15	008538	8	B	5.5	7.5	28.8	12.8	85	-	8	0.25	42	2090@52
9.5L-15	339377	8	B	8.00	9.4	30.0	13.3	89	-	8	0.25	58	2470@44
9.5L-15	008540	8	B	8.00	9.4	30.6	13.5	90	-	8	0.25	58	2470@44
9.5L-15	355860	12	B	8.00	9.4	30	13.3	89	-	8	0.25	58	3150@64
11L-15	339547	8	B	8.00	9.4	30.0	13.3	89	-	8	0.25	58	3150@64
11L-15	008531	8	B	8.00	10.7	30.8	13.7	91	-	8	0.25	75	2540@36
11L-15	339482	12	B	8.00	10.7	30.6	13.6	90	-	8	0.25	75	2540@36
12.5L-15	339598	10	B	10.00	12.3	32.1	14.3	95	-	8	0.25	98	3420@44
12.5L-15	354538	12	B	10.00	12.3	32.1	14.3	95	-	8	0.25	98	3860@52
12.5L-15	378457	18	B	10.00	12.3	32.1	14.3	95	-	8	0.25	98	4680@72
11L-16	008532	8	B	8.00	10.8	31.3	14.0	92	-	8	0.25	80	2680@36
12.5L-16	356840	14	B	10.00	12.3	33.1	14.7	100	-	8	0.25	110	4180@56
14L-16.1	354686	8	B	11.00	14.0	37.0	16.5	101	-	12	0.38	136	3860@32
14L-16.1	008533	8	B	11.00	14.7	37.2	16.6	110	-	12	0.38	136	3860@32
14L-16.1	376876	14	B	11.00	14.0	37.0	16.5	101	-	12	0.38	136	5200@52
16.5L-16.1	339636	10	B	14.00	16.3	39.9	17.9	110	-	14	0.44	160	5200@36
16.5L-16.1	342483	14	B	14.00	16.3	39.9	17.9	110	-	14	0.44	160	6400@48
7.50-20	339326	6	B	5.50	7.9	34.7	15.4	102	-	8	0.25	57	2090@36
7.50-20	008537	6	B	5.50	7.9	35.1	15.5	104	-	8	0.25	57	2090@36
TUBE TYPE													
8.5L-14	339148	6	B	6.00	8.4	28.2	12.5	85	-	8	0.25	46	1870@36
6.00-16	339199	6	B	4.00	6.2	27.9	13.4	84	-	8	0.25	40	1520@44

STUBBLE STOMPER

TUBELESS													
5.90-15	362034	4	B	4.50	6.0	26.0	11.6	77	-	7	0.22	34	1140@36

Addition from previous data book
 See General Farm Tire Information, Approved Rim Contours (pages 168-172) for a listing of approved rim contours by tire size.
 See Load & Inflation Tables (pages 92-163) for more details.

FARM TIRE — I-1



Shock-fortified nylon cord for greater impact resistance.

Tough construction for long wear.

TIRE DIMENSIONS (IN.)												CONTACT AREA	
TIRE SIZE	MATERIAL NUMBER	PLY RATING	SPEED SYMBOL RATING	DESIGN RIM WIDTH	OVERALL WIDTH	OVERALL DIA.	STATIC LOADED RADIUS	ROLLING CIRCUM.	ROLLING CIRCUM. INDEX	BAR HEIGHT 32NDS	BAR HEIGHT INCHES	FLAT PLATE (SQ. IN.)	MAX. LOAD & INFL. (LBS. @ PSI)
TUBELESS													
10.00-15	329614	8	B	8.00	10.6	33.3	14.8	94	-	11	0.34	79	3200@40
10.00-15	008529	8	B	8.00	10.6	33.6	14.9	99	-	11	0.34	79	3200@40
19L-16.1	359777	12	B	16.00	18.5	41.6	18.5	115	-	16	0.50	225	6600@36
21.5L-16.1	318507	10	B	18.00	21.8	43.5	19.3	120	-	14	0.44	252	6600@28
21.5L-16.1	008575	14	B	18.00	21.8	43.2	19.2	127	-	14	0.44	252	7850@36

RADIAL FARM

BIAS FARM

FRONTS & IMPLEMENTS

FORESTRY & FLOTATION

DISCONTINUED

LOAD & INFLATION TABLES

GENERAL TIRE INFORMATION

WARRANTY

 Addition from previous data book

See General Farm Tire Information, Approved Rim Contours (pages 168-172) for a listing of approved rim contours by tire size.
See Load & Inflation Tables (pages 92-163) for more details.

RIB IMPLEMENT — I-1



Engineered with a five-rib tread design that guards against side-slip on hills.

Specially formulated rubber resists weathering.

Designed for low rolling resistance, saving fuel.

RADIAL FARM

BIAS FARM

FRONTS &
IMPLEMENT'S

FORESTRY &
FLOTATION

DISCONTINUED

LOAD & INFLATION
TABLES

GENERAL TIRE
INFORMATION

WARRANTY

TIRE DIMENSIONS (IN.)												CONTACT AREA	
TIRE SIZE	MATERIAL NUMBER	PLY RATING	SPEED SYMBOL RATING	DESIGN RIM WIDTH	OVERALL WIDTH	OVERALL DIA.	STATIC LOADED RADIUS	ROLLING CIRCUM.	ROLLING CIRCUM. INDEX	BAR HEIGHT 32NDS	BAR HEIGHT INCHES	FLAT PLATE (SQ. IN.)	MAX. LOAD & INFL. (LBS. @ PSI)
TUBELESS													
31X13.50-15	008554	8	B	10.00	13.8	30.8	13.8	84	-	12	0.38	105	2600@45
31X13.50-15	358622	12	B	10.00	13.8	30.8	13.8	84	-	12	0.38	105	3520@75
11.25-24	324221	8	B	10.00	12.9	46.7	21.5	141	-	13	0.41	127	4080@32
11.25-24	355534	12	B	10.00	12.9	46.7	21.5	141	-	13	0.41	127	5200@48
11.25-28	326453	12	B	10.00	12.9	50.7	23.5	153	-	13	0.41	132	5360@48
TUBE TYPE													
9.00-24	356212	8	B	8.00	10.8	43.1	20.0	130	-	12	0.38	95	3520@40
9.00-24	008555	8	B	8.00	10.8	43.1	20.0	127	-	12	0.38	95	3520@40

Addition from previous data book

See General Farm Tire Information, Approved Rim Contours (pages 168-172) for a listing of approved rim contours by tire size.

See Load & Inflation Tables (pages 92-163) for more details.

RIB DUPLEX FARM — I-1



The wide-rib tread design on Rib Duplex Farm aids in flotation.

Tough, cut-resistant rubber compounds and shock-fortified body promote long life and reduce downtime.

Designed with exceptional steering ease and high flotation on front-wheel positions.

TIRE DIMENSIONS (IN.)												CONTACT AREA	
TIRE SIZE	MATERIAL NUMBER	PLY RATING	SPEED SYMBOL RATING	DESIGN RIM WIDTH	OVERALL WIDTH	OVERALL DIA.	STATIC LOADED RADIUS	ROLLING CIRCUM.	ROLLING CIRCUM. INDEX	BAR HEIGHT 32NDS	BAR HEIGHT INCHES	FLAT PLATE (SQ. IN.)	MAX. LOAD & INFL. (LBS. @ PSI)
TUBELESS													
36X16B17.5	318523	8	B	10.50	15.8	36.8	16.7	112	-	16	0.50	98	4400@40
36X16-17.5	361968	14	B	10.50	15.8	36.8	16.7	112	-	16	0.50	98	6950@75

DUO RIB PLANTER — I-1



Specifically designed for firming soil around seed as it's planted.

Deep ribs help keep your planter in line on side hills.

Cut-resistant rubber compounds for longer wear and reduced downtime.

TIRE DIMENSIONS (IN.)												CONTACT AREA	
TIRE SIZE	MATERIAL NUMBER	PLY RATING	SPEED SYMBOL RATING	DESIGN RIM WIDTH	OVERALL WIDTH	OVERALL DIA.	STATIC LOADED RADIUS	ROLLING CIRCUM.	ROLLING CIRCUM. INDEX	BAR HEIGHT 32NDS	BAR HEIGHT INCHES	FLAT PLATE (SQ. IN.)	MAX. LOAD & INFL. (LBS. @ PSI)
TUBELESS													
7.50-20	313424	4	A8	5.50	8.5	37.1	17.4	112	-	24	0.75	67	1760@28
TUBE TYPE													
7.60-15	325864	6	A8	5.50	7.6	29.3	13.3	84	-	21	0.66	42	1760@42

 Addition from previous data book

See General Farm Tire Information, Approved Rim Contours (pages 168-172) for a listing of approved rim contours by tire size.
See Load & Inflation Tables (pages 92-163) for more details.

ALL NON-SKID (ANS) FARM — I-2



A non-aggressive, multi-block tread pattern is designed for free-rolling wheels on tractors and trailers and helps to minimize ground disturbance.

Engineered with shock-fortified nylon cord for increased impact resistance.

RADIAL FARM

BIAS FARM

FRONTS & IMPLEMENTS

FORESTRY & FLOTATION

DISCONTINUED

LOAD & INFLATION TABLES

GENERAL TIRE INFORMATION

WARRANTY

TIRE DIMENSIONS (IN.)												CONTACT AREA	
TIRE SIZE	MATERIAL NUMBER	PLY RATING	SPEED SYMBOL RATING	DESIGN RIM WIDTH	OVERALL WIDTH	OVERALL DIA.	STATIC LOADED RADIUS	ROLLING CIRCUM.	ROLLING CIRCUM. INDEX	BAR HEIGHT 32NDS	BAR HEIGHT INCHES	FLAT PLATE (SQ. IN.)	MAX. LOAD & INFL. (LBS. @ PSI)
TUBELESS													
13.50-16.1	011681	10	B	11.00	14.6	39.8	17.2	120	-	19	0.59	165	4940@40
16.5L-16.1	008506	6	B	14.00	16.3	40.9	17.6	120	-	19	0.59	175	3960@24
16.5L-16.1	317365	10	B	14.00	16.3	40.8	17.6	116	-	19	0.59	175	5200@36

TURF & FIELD — I-3



Extra traction and resistance to lateral sway deliver top performance.

Extra flotation prevents chunking and cutting of turf on level and sloping areas.

TIRE DIMENSIONS (IN.)												CONTACT AREA	
TIRE SIZE	MATERIAL NUMBER	PLY RATING	SPEED SYMBOL RATING	DESIGN RIM WIDTH	OVERALL WIDTH	OVERALL DIA.	STATIC LOADED RADIUS	ROLLING CIRCUM.	ROLLING CIRCUM. INDEX	BAR HEIGHT 32NDS	BAR HEIGHT INCHES	FLAT PLATE (SQ. IN.)	MAX. LOAD & INFL. (LBS. @ PSI)
TUBELESS													
21.5L-16.1	312770	6	A8	18.00	20.8	44.1	19	127	-	33	1.03	190	2760@12
21.5L-16.1	355887	10	A8	18.00	20.8	44.1	19	127	-	33	1.03	190	3860@22

 Addition from previous data book

See General Farm Tire Information, Approved Rim Contours (pages 168-172) for a listing of approved rim contours by tire size.

See Load & Inflation Tables (pages 92-163) for more details.

POWER IMPLEMENT — I-3



Designed for traction wheels on self-powered machines like trenchers or hay rakes.

Available with either a directional tread or a non-directional tread for ground-driven equipment.

Designed to help deliver long wear.

TIRE SIZE	MATERIAL NUMBER	PLY RATING	SPEED SYMBOL RATING	TIRE DIMENSIONS (IN.)								CONTACT AREA		
				DESIGN RIM WIDTH	OVERALL WIDTH	OVERALL DIA.	STATIC LOADED RADIUS	ROLLING CIRCUM.	ROLLING CIRCUM. INDEX	BAR HEIGHT 32NDS	BAR HEIGHT INCHES	FLAT PLATE (SQ. IN.)	MAX. LOAD & INFL. (LBS. @ PSI)	
TUBELESS														
A	5.00-15	310069	4	B	3.00	5.6	25.8	11.5	78	-	15	0.47	32	965@36
B	7.60-15	340529	6	B	5.50	7.5	29.2	13.3	87	-	16	0.50	60	1760@40
B	7.60-15	008551	6	B	5.50	7.5	29.2	13.3	87	-	16	0.50	60	1760@40
B	12.5L-15	008548	8	B	10.00	12.5	33.5	15.1	99	-	22	0.69	110	3000@36
C	13.50-16.1	008549	8	B	11.00	15.0	41.1	17.8	121	-	23	0.72	166	4300@32
B	16.5L-16.1	008550	6	B	14.00	16.0	41.1	17.8	121	-	25	0.78	198	3960@24
B	16.5L-16.1	342467	10	B	14.00	16.0	41.0	17.7	124	-	25	0.78	198	5200@36
B	21.5L-16.1	359408	8	B	18.00	21.5	45.8	19.5	126	-	33	1.03	306	6000@24
B	21.5L-16.1	359416	14	B	18.00	21.5	45.8	19.5	126	-	33	1.03	306	7850@36

NON-DIRECTIONAL DUPLEX FARM — I-3



Built of exclusive rubber compounds that resist weathering, snags, and punctures.

Offers a wide tread design that spreads load weight and reduces rear-wheel compaction.

Non-directional tread design helps to improve traction performance.

TIRE SIZE	MATERIAL NUMBER	PLY RATING	SPEED SYMBOL RATING	TIRE DIMENSIONS (IN.)								CONTACT AREA	
				DESIGN RIM WIDTH	OVERALL WIDTH	OVERALL DIA.	STATIC LOADED RADIUS	ROLLING CIRCUM.	ROLLING CIRCUM. INDEX	BAR HEIGHT 32NDS	BAR HEIGHT INCHES	FLAT PLATE (SQ. IN.)	MAX. LOAD & INFL. (LBS. @ PSI)
TUBELESS													
40X19B19.5	323004	14	B	15.00	18.1	39.6	17.9	121	-	26	0.81	148	7850@65

Addition from previous data book

See General Farm Tire Information, Approved Rim Contours (pages 168-172) for a listing of approved rim contours by tire size.

See Load & Inflation Tables (pages 92-163) for more details.

FLOTATION IMPLEMENT — I-3



Designed with a large footprint that reduces soil compaction and helps resist side-slip on hillsides.

A special-purpose flotation tire for free-rolling wheels, with high-density rubber that stands tough against stubble.

Heavy-duty shock-fortified nylon-cord body aids in resisting impacts.

TIRE SIZE	MATERIAL NUMBER	PLY RATING	SPEED SYMBOL RATING	TIRE DIMENSIONS (IN.)								CONTACT AREA	
				DESIGN RIM WIDTH	OVERALL WIDTH	OVERALL DIA.	STATIC LOADED RADIUS	ROLLING CIRCUM.	ROLLING CIRCUM. INDEX	BAR HEIGHT 32NDS	BAR HEIGHT INCHES	FLAT PLATE (SQ. IN.)	MAX. LOAD & INFL. (LBS. @ PSI)
TUBELESS													
600/55-22.5	364653	16	B	20.00	23.6	50.0	21.3	142	-	35	1.09	310	10200@38
700/50-22.5	359003	16	B	24.00	27.4	50.0	21.3	142	-	35	1.09	363	11700@35

SUPER TRACTION LOADER — I-3



Designed with deep, overlapping bar cleats and a low-profile design to provide traction performance.

A reinforced tread designed to help promote long wear.

TIRE SIZE	MATERIAL NUMBER	PLY RATING	SPEED SYMBOL RATING	TIRE DIMENSIONS (IN.)								CONTACT AREA	
				DESIGN RIM WIDTH	OVERALL WIDTH	OVERALL DIA.	STATIC LOADED RADIUS	ROLLING CIRCUM.	ROLLING CIRCUM. INDEX	BAR HEIGHT 32NDS	BAR HEIGHT INCHES	FLAT PLATE (SQ. IN.)	MAX. LOAD & INFL. (LBS. @ PSI)
TUBELESS													
27X8.50-15	350672	6	B	7.00	8.4	26.7	12.1	79	41	13	0.41	71	2480@45

 Addition from previous data book

See General Farm Tire Information, Approved Rim Contours (pages 168-172) for a listing of approved rim contours by tire size.

See Load & Inflation Tables (pages 92-163) for more details.

FLOTATION 23° — HF-3



The wide tread distributes weight across a large contact area, minimizing compaction.

A large chamber of air volume allows for low inflation pressure, which helps to improve flotation.

With Firestone's innovative 23° tread design, more of the bar grips the surface, making it ideal for farmers looking for increased traction while more efficiently transferring horsepower to the ground, saving both time and fuel¹.

TIRE DIMENSIONS (IN.)												CONTACT AREA	MAX. LOAD & INFL. (LBS. @ PSI)
TIRE SIZE	MATERIAL NUMBER	PLY RATING	SPEED SYMBOL RATING	DESIGN RIM WIDTH	OVERALL WIDTH	OVERALL DIA.	STATIC LOADED RADIUS	ROLLING CIRCUM.	ROLLING CIRCUM. INDEX	BAR HEIGHT 32NDS	BAR HEIGHT INCHES	FLAT PLATE (SQ. IN.)	
TUBELESS													
31X15.50-15	314420	8	A3	13.00	15.5	31.2	14.1	93	-	23	0.72	110	3645@45
66X43.00-25	375465	20	B	36.00	41.3	66.5	29.5	197	-	64	2.00	625	2745@42

FARM IMPLEMENT — HF-1



Flotation design created specifically for planters with a seed-firming center rib.

Shock-fortified nylon-cord body resists impacts.

Cut-resistant sidewall compound reduces downtime.

TIRE DIMENSIONS (IN.)												CONTACT AREA	MAX. LOAD & INFL. (LBS. @ PSI)
TIRE SIZE	MATERIAL NUMBER	PLY RATING	SPEED SYMBOL RATING	DESIGN RIM WIDTH	OVERALL WIDTH	OVERALL DIA.	STATIC LOADED RADIUS	ROLLING CIRCUM.	ROLLING CIRCUM. INDEX	BAR HEIGHT 32NDS	BAR HEIGHT INCHES	FLAT PLATE (SQ. IN.)	
TUBELESS													
27X8.50-15	379460	8	B	7.00	8.4	26.7	13	84	-	11	0.34	34	1820@60
27X8.50-15	008534	8	B	7.00	8.4	26.7	12.5	79	-	11	0.34	34	1820@60

¹ Compared to 45° tread pattern



Addition from previous data book

See General Farm Tire Information, Approved Rim Contours (pages 168-172) for a listing of approved rim contours by tire size.

See Load & Inflation Tables (pages 92-163) for more details.

TURF & FIELD — HF-2



Designed with a cut-resistant sidewall that aids in reducing downtime.

Shock-fortified nylon-cord body ply helps resist impacts.

Stubble Stomper lineup offers a specially fortified tread rubber resists stubble punctures and tire erosion.

RADIAL FARM

BIAS FARM

FRONTS & IMPLEMENTS

FORESTRY & FLOTATION

DISCONTINUED

LOAD & INFLATION TABLES

GENERAL TIRE INFORMATION

WARRANTY

TIRE DIMENSIONS (IN.)												CONTACT AREA	MAX. LOAD & INFL. (LBS. @ PSI)
TIRE SIZE	MATERIAL NUMBER	PLY RATING	SPEED SYMBOL RATING	DESIGN RIM WIDTH	OVERALL WIDTH	OVERALL DIA.	STATIC LOADED RADIUS	ROLLING CIRCUM.	ROLLING CIRCUM. INDEX	BAR HEIGHT 32NDS	BAR HEIGHT INCHES	FLAT PLATE (SQ. IN.)	
TUBELESS													
29X12.00-15	359785	6	A3	10.00	12.2	29.2	12.8	86	-	11	0.34	-	2260@30
31X13.50-15	354856	8	A3	10.00	13.7	30.6	13.5	93	-	11	0.34	-	3430@45

STUBBLE STOMPER

TUBELESS													
31X13.50-15	362190	10	A3	10.00	13.7	30.6	13.5	93	-	11	0.34	84	3080@60

Addition from previous data book

See General Farm Tire Information, Approved Rim Contours (pages 168-172) for a listing of approved rim contours by tire size.

See Load & Inflation Tables (pages 92-163) for more details.

FARM SERVICE LUG-M — R-1



Specially designed to help optimize ride, comfort, and wear.

Durable nylon body plies help provide long tread life.



TIRE DIMENSIONS (IN.)												CONTACT AREA	MAX. LOAD & INFL. (LBS. @ PSI)
TIRE SIZE	MATERIAL NUMBER	PLY RATING	SPEED SYMBOL RATING	DESIGN RIM WIDTH	OVERALL WIDTH	OVERALL DIA.	STATIC LOADED RADIUS	ROLLING CIRCUM.	ROLLING CIRCUM. INDEX	BAR HEIGHT 32NDS	BAR HEIGHT INCHES	FLAT PLATE (SQ. IN.)	
TUBELESS													
5-14	344443	4	A6	4.00	5.0	23.8	11.3	72	-	32	1.00	-	550@35
8-16	344494	4	A6	5.00	7.4	30.9	14.3	91	-	39	1.22	-	1047@23
8-18	355925	6	A6	6.00	7.8	33.1	15.3	98	-	39	1.22	-	1146@23
9.5-22	363752	6	A6	8.00	9.5	39.2	18.3	117	-	43	1.34	-	1980@32

FARM SERVICE LUG-18 — R-1



Designed specifically for use in hard or soft soil conditions.

A low bar angle aids in optimizing traction.



TIRE DIMENSIONS (IN.)												CONTACT AREA	MAX. LOAD & INFL. (LBS. @ PSI)
TIRE SIZE	MATERIAL NUMBER	PLY RATING	SPEED SYMBOL RATING	DESIGN RIM WIDTH	OVERALL WIDTH	OVERALL DIA.	STATIC LOADED RADIUS	ROLLING CIRCUM.	ROLLING CIRCUM. INDEX	BAR HEIGHT 32NDS	BAR HEIGHT INCHES	FLAT PLATE (SQ. IN.)	
TUBELESS													
8.3-22	378695	6	A6	7.00	8.3	37.2	17.4	112	-	39	1.22	-	1675@35

Addition from previous data book

See General Farm Tire Information, Approved Rim Contours (pages 168-172) for a listing of approved rim contours by tire size.
See Load & Inflation Tables (pages 92-163) for more details.

FARM SERVICE DIA — R-3



Designed for small tractors with a small-diameter design that is ideal for turf conditions.

Special tread design that helps to maximize flotation and minimize turf damage on surfaces such as lawns, cemeteries, golf courses, and sandy soils.



RADIAL FARM

BIAS FARM

FRONTS & IMPLEMENTS

TIRE DIMENSIONS (IN.)												CONTACT AREA	
TIRE SIZE	MATERIAL NUMBER	PLY RATING	SPEED SYMBOL RATING	DESIGN RIM WIDTH	OVERALL WIDTH	OVERALL DIA.	STATIC LOADED RADIUS	ROLLING CIRCUM.	ROLLING CIRCUM. INDEX	BAR HEIGHT 32NDS	BAR HEIGHT INCHES	FLAT PLATE (SQ. IN.)	MAX. LOAD & INFL. (LBS. @ PSI)
TUBELESS													
6-12	010052	4	A6	5.00	6.1	22.2	10.3	66	-	11	0.34	-	600@28
6-14	010054	4	A6	5.00	6.4	24.2	11.9	77	-	10	0.31	-	675@28
11.2-24	344869	4	A6	9.00	10.8	42.2	18.9	121	-	21	0.66	-	1650@18

FARM SERVICE RIB — F-2



Three-rib front tire designed for small agricultural tractors.

Designed to encourage positive steering control, especially in loose soil conditions and side slopes.



FORESTRY & FLOTATION

DISCONTINUED

LOAD & INFLATION TABLES

GENERAL TIRE INFORMATION

WARRANTY

TIRE DIMENSIONS (IN.)												CONTACT AREA	
TIRE SIZE	MATERIAL NUMBER	PLY RATING	SPEED SYMBOL RATING	DESIGN RIM WIDTH	OVERALL WIDTH	OVERALL DIA.	STATIC LOADED RADIUS	ROLLING CIRCUM.	ROLLING CIRCUM. INDEX	BAR HEIGHT 32NDS	BAR HEIGHT INCHES	FLAT PLATE (SQ. IN.)	MAX. LOAD & INFL. (LBS. @ PSI)
TUBELESS													
4.50-10	344648	4	A6	3.00	4.8	19.2	8.9	56	-	13	0.41	-	540@44

Addition from previous data book

See General Farm Tire Information, Approved Rim Contours (pages 168-172) for a listing of approved rim contours by tire size.
See Load & Inflation Tables (pages 92-163) for more details.

AG IMPLEMENT — I-1



Ideal for free-rolling wheels on wagons and trailers.

Nylon-cord body built to resist impacts.

REGENCY

TIRE DIMENSIONS (IN.)												CONTACT AREA	
TIRE SIZE	MATERIAL NUMBER	PLY RATING	SPEED SYMBOL RATING	DESIGN RIM WIDTH	OVERALL WIDTH	OVERALL DIA.	STATIC LOADED RADIUS	ROLLING CIRCUM.	ROLLING CIRCUM. INDEX	BAR HEIGHT 32NDS	BAR HEIGHT INCHES	FLAT PLATE (SQ. IN.)	MAX. LOAD & INFL. (LBS. @ PSI)
TUBELESS													
9.5L-14	378763	8	B	14.00	9.5	28.5	12.7	86	-	8	0.25	-	2400@44
7.60-15	378338	8	B	15.00	7.9	29.0	12.9	86	-	8	0.25	-	2090@52
9.5L-15	378287	8	B	15.00	9.8	30.4	13.1	89	-	8	0.25	-	2470@44
11L-15	378304	8	B	15.00	10.9	30.3	13.5	90	-	8	0.25	-	2540@36
12.5L-15	378321	10	B	15.00	12.4	32.4	14.4	95	-	8	0.25	-	3420@44

RADIAL FARM

BIAS FARM

FRONTS & IMPLEMENTS

FORESTRY & FLOTATION

DISCONTINUED

LOAD & INFLATION TABLES

GENERAL TIRE INFORMATION

WARRANTY

AG FRONT 4-RIB — F-2



Four-rib design for great hold, flotation, and slip resistance.

Self-cleaning tread pattern designed for quick steering response.

REGENCY

TIRE DIMENSIONS (IN.)												CONTACT AREA	
TIRE SIZE	MATERIAL NUMBER	PLY RATING	SPEED SYMBOL RATING	DESIGN RIM WIDTH	OVERALL WIDTH	OVERALL DIA.	STATIC LOADED RADIUS	ROLLING CIRCUM.	ROLLING CIRCUM. INDEX	BAR HEIGHT 32NDS	BAR HEIGHT INCHES	FLAT PLATE (SQ. IN.)	MAX. LOAD & INFL. (LBS. @ PSI)
TUBELESS													
11.00-16	378270	8	A8	16.00	12.9	38.0	17.2	113	-	29	0.90	-	2600@40

 Addition from previous data book

See General Farm Tire Information, Approved Rim Contours (pages 168-172) for a listing of approved rim contours by tire size.

See Load & Inflation Tables (pages 92-163) for more details.

AG FRONT 3-RIB — F-2



REGENCY



Front tractor tire with wide three-rib design for most types of farming conditions.

Self-cleaning tread pattern designed for quick steering response.

RADIAL FARM

BIAS FARM

FRONTS & IMPLEMENTS

TIRE SIZE	MATERIAL NUMBER	PLY RATING	SPEED SYMBOL RATING	TIRE DIMENSIONS (IN.)								CONTACT AREA	
				DESIGN RIM WIDTH	OVERALL WIDTH	OVERALL DIA.	STATIC LOADED RADIUS	ROLLING CIRCUM.	ROLLING CIRCUM. INDEX	BAR HEIGHT 32NDS	BAR HEIGHT INCHES	FLAT PLATE (SQ. IN.)	MAX. LOAD & INFL. (LBS. @ PSI)
TUBELESS													
6.00-16	378253	6	A8	16.00	6.3	29.3	13.6	87	-	19	0.59	-	1140@52
10.00-16	378032	8	A8	16.00	11.0	36.0	16.6	105	-	33	1.03	-	2340@44

AG TRACTOR — G-1



REGENCY



A low-bar angle means that more of the bar grips the surface, making it ideal for farmers looking for increased traction.

FORESTRY & FLOTATION

DISCONTINUED

LOAD & INFLATION TABLES

GENERAL TIRE INFORMATION

WARRANTY

TIRE SIZE	MATERIAL NUMBER	PLY RATING	SPEED SYMBOL RATING	TIRE DIMENSIONS (IN.)								CONTACT AREA	
				DESIGN RIM WIDTH	OVERALL WIDTH	OVERALL DIA.	STATIC LOADED RADIUS	ROLLING CIRCUM.	ROLLING CIRCUM. INDEX	BAR HEIGHT 32NDS	BAR HEIGHT INCHES	FLAT PLATE (SQ. IN.)	MAX. LOAD & INFL. (LBS. @ PSI)
TUBELESS													
5-12	382333	4	A6	12.00	5.0	21.0	9.6	63	-	17	0.53	-	495@34
6-12	382367	4	A6	12.00	6.1	22.7	11.1	69	-	19	0.59	-	600@28
6-14	382401	4	A6	14.00	6.3	25.0	11.5	75	-	19	0.59	-	660@28
7-14	382384	4	A6	14.00	7.2	27.2	12.2	81	-	20	0.63	-	785@24
6.00-16	382350	4	A6	16.00	6.3	29.0	13.4	87	-	31	0.97	-	740@28
7-16	382418	6	A6	16.00	7.3	29.4	13.6	87	-	35	1.09	-	1100@36
8-16	382435	6	A6	16.00	8.3	31.3	14.4	93	-	22	0.69	-	1360@28

Addition from previous data book
 See General Farm Tire Information, Approved Rim Contours (pages 168-172) for a listing of approved rim contours by tire size.
 See Load & Inflation Tables (pages 92-163) for more details.

FORESTRY SPECIAL WITH CRC (WTP)—LS-2



Rugged CRC (cut-resistant compound) resists snags and tears and meets the demands of high-horsepower and heavy-load equipment.

Keep out debris with heavy-duty bead-and-rim protection.

TIRE DIMENSIONS (IN.)												CONTACT AREA		
TIRE SIZE	MATERIAL NUMBER	PLY RATING	SPEED SYMBOL RATING	DESIGN RIM WIDTH	OVERALL WIDTH	OVERALL DIA.	STATIC LOADED RADIUS	ROLLING CIRCUM.	ROLLING CIRCUM. INDEX	BAR HEIGHT 32NDS	BAR HEIGHT INCHES	FLAT PLATE (SQ. IN.)	MAX. LOAD & INFL. (LBS. @ PSI)	
TUBELESS														
A	23.1B26	000407	20	A2	20.00	23.1	63.5	28.6	188	-	66	2.06	261	15200@45
A	24.5B32	006284	20	A2	21.00	24.5	70.9	32.0	209	-	67	2.09	414	18700@45
A	28LB26	362511	16	A2	25.00	28.1	64.5	29.2	192	-	70	2.19	302	14800@35
A	28LB26	004458	20	A2	25.00	28.1	65.5	29.8	192	-	70	2.19	377	16100@40
A	30.5LB32	371555	26	A2	27.00	30.5	74.0	33.2	219	-	72	2.25	378	22000@45
A	30.5LB32	004444	32	A2	27.00	30.5	74.2	34.0	219	-	72	2.25	443	24700@55
B	DH35.5LB32	371606	24	A2	31.00	35.5	79.2	35.6	235	-	81	2.53	641	24700@35
B	DH35.5LB32	004445	30	A2	31.00	35.5	80.0	35.8	235	-	81	2.53	641	29100@45
TUBE TYPE														
A	18.4-26	361771	10	A2	16.00	18.4	56.9	26.2	171	-	64	2.00	182	8050@30
A	23.1B26	361801	14	A2	20.00	23.1	63.5	28.6	188	-	66	2.06	261	12800@35
A	18.4-34	361887	10	A2	16.00	18.4	65.2	30.6	198	-	64	2.00	206	9100@30

 Addition from previous data book

See General Farm Tire Information, Approved Rim Contours (pages 168-172) for a listing of approved rim contours by tire size.

See Load & Inflation Tables (pages 92-163) for more details.

FLOTATION 23° DEEP TREAD LOGGER—HF-3



Designed with a skid depth from 1.8" to 2.5" and a wide footprint for flotation on soft ground, which, in combination with the 23° tread bar, helps deliver better traction performance.

Fuel savings as much as 40% greater than a narrower tire can deliver.

RADIAL FARM

BIAS FARM

FRONTS & IMPLEMENTS

FORESTRY & FLOTATION

TIRE DIMENSIONS (IN.)												CONTACT AREA	
TIRE SIZE	MATERIAL NUMBER	PLY RATING	SPEED SYMBOL RATING	DESIGN RIM WIDTH	OVERALL WIDTH	OVERALL DIA.	STATIC LOADED RADIUS	ROLLING CIRCUM.	ROLLING CIRCUM. INDEX	BAR HEIGHT 32NDS	BAR HEIGHT INCHES	FLAT PLATE (SQ. IN.)	MAX. LOAD & INFL. (LBS. @ PSI)
TUBELESS													
54X37.00-25	352063	12	A2	32.00	37.0	56.3	25.8	172	-	61	1.91	474	13200@35
54X37.00B25	373102	20	A2	32.00	37.0	56.3	25.8	172	-	61	1.91	474	17100@55
66X43.00-25	354392	14	A2	36.00	41.5	67.8	30.3	202	-	74	2.31	625	19300@35
66X43.00-26	354422	14	A2	36.00	41.5	67.8	30.3	202	-	74	2.31	625	19000@35
76X50.00B32	359130	16	A2	44.00	48.6	78.5	36.1	233	-	80	2.50	965	25400@35

FLOTATION 23° EXTRA-DEEP TREAD LOGGER — HF-4



Helps deliver traction in the toughest conditions, with a tread depth that is 1" deeper than Firestone HF-3 flotation tires.

Impact from punctures, cuts and snags is reduced with a special wide arc that protects the sidewall and four steel-cord belts.

The 23° tread design also improves traction and saves time and fuel¹

DISCONTINUED

LOAD & INFLATION TABLES

GENERAL TIRE INFORMATION

WARRANTY

TIRE DIMENSIONS (IN.)												CONTACT AREA	
TIRE SIZE	MATERIAL NUMBER	PLY RATING	SPEED SYMBOL RATING	DESIGN RIM WIDTH	OVERALL WIDTH	OVERALL DIA.	STATIC LOADED RADIUS	ROLLING CIRCUM.	ROLLING CIRCUM. INDEX	BAR HEIGHT 32NDS	BAR HEIGHT INCHES	FLAT PLATE (SQ. IN.)	MAX. LOAD & INFL. (LBS. @ PSI)
TUBELESS													
66X43.00-25	006281	20	A2	36.00	40.4	71.2	32.6	-	-	109	3.41	469	23400@50
DH73X44.00B32	006279	20	A2	36.00	40.7	74.9	34.5	-	-	112	3.50	638	27600@50

¹ Compared to 45° tread pattern



Additional from previous data book

See General Farm Tire Information, Approved Rim Contours (pages 168-172) for a listing of approved rim contours by tire size. See Load & Inflation Tables (pages 92-163) for more details.

FLOTATION 23° DEEP TREAD (WTP) LOGGER —HF-4



3.5" of tread depth delivers pull and traction in wet, swampy areas.

Special rubber compounds help improve resistance to cuts, snags and tears, while the steel-cord belt design helps with impact and puncture resistance.

Firestone's innovative 23° tread design makes it ideal for loggers looking for increased traction.

TIRE DIMENSIONS (IN.)												CONTACT AREA	
TIRE SIZE	MATERIAL NUMBER	PLY RATING	SPEED SYMBOL RATING	DESIGN RIM WIDTH	OVERALL WIDTH	OVERALL DIA.	STATIC LOADED RADIUS	ROLLING CIRCUM.	ROLLING CIRCUM. INDEX	BAR HEIGHT 32NDS	BAR HEIGHT INCHES	FLAT PLATE (SQ. IN.)	MAX. LOAD & INFL. (LBS. @ PSI)
TUBELESS													
67X34.00-25	354902	14	A2	30.00	33.7	69.2	30.3	204	-	112	3.50	550	20900@40
67X34.00B25	006276	22	A2	30.00	33.7	68.0	30.5	-	-	112	3.50	394	26800@60
67X34.00-26	354899	14	A2	30.00	33.7	69.2	30.3	204	-	112	3.50	550	20900@40

FORESTY EL 700 — HF-1



Designed for use on forwarders and harvesters.

Offers resistance to cuts, snags, tears, and weather checking through special tread and sidewall rubber compounds and steel tread plies.

20-ply construction is ideal for handling heavy loads.

TIRE DIMENSIONS (IN.)												CONTACT AREA	
TIRE SIZE	MATERIAL NUMBER	PLY RATING	SPEED SYMBOL RATING	DESIGN RIM WIDTH	OVERALL WIDTH	OVERALL DIA.	STATIC LOADED RADIUS	ROLLING CIRCUM.	ROLLING CIRCUM. INDEX	BAR HEIGHT 32NDS	BAR HEIGHT INCHES	FLAT PLATE (SQ. IN.)	MAX. LOAD & INFL. (LBS. @ PSI)
TUBELESS													
710/45B26.5	371623	20	A2	24.00	28.0	52.8	23.2	159	-	32	1.00	345	15200@73

Addition from previous data book

See General Farm Tire Information, Approved Rim Contours (pages 168-172) for a listing of approved rim contours by tire size.

See Load & Inflation Tables (pages 92-163) for more details.

FLOTATION ALL TERRAIN — HF-1



The shallow tread depth and wide-width design allows for low inflation pressure to help improve flotation over loose soil and sand.

Weight distributed across a larger footprint helps to minimize compaction and turf disturbance.

RADIAL FARM

BIAS FARM

FRONTS & IMPLEMENTS

FORESTRY & FLOTATION

DISCONTINUED

LOAD & INFLATION TABLES

GENERAL TIRE INFORMATION

WARRANTY

TIRE DIMENSIONS (IN.)												CONTACT AREA	
TIRE SIZE	MATERIAL NUMBER	PLY RATING	SPEED SYMBOL RATING	DESIGN RIM WIDTH	OVERALL WIDTH	OVERALL DIA.	STATIC LOADED RADIUS	ROLLING CIRCUM.	ROLLING CIRCUM. INDEX	BAR HEIGHT 32NDS	BAR HEIGHT INCHES	FLAT PLATE (SQ. IN.)	MAX. LOAD & INFL. (LBS. @ PSI)
TUBELESS													
66X44.00-25	371674	20	B	36.00	41.0	67.0	29.1	197	-	13	0.41	644	14300@45

Addition from previous data book

See General Farm Tire Information, Approved Rim Contours (pages 168-172) for a listing of approved rim contours by tire size.
See Load & Inflation Tables (pages 92-163) for more details.

FLOTATION 23° (CENTER RIB) — HF-2



Designed with a wide center rib that helps deliver even wear on hard surfaces.

With Firestone's innovative 23° tread design, more of the bar grips the surface, making it ideal for farmers looking for increased traction while more efficiently transferring horsepower to the ground, saving both time and fuel¹.

TIRE DIMENSIONS (IN.)												CONTACT AREA	
TIRE SIZE	MATERIAL NUMBER	PLY RATING	SPEED SYMBOL RATING	DESIGN RIM WIDTH	OVERALL WIDTH	OVERALL DIA.	STATIC LOADED RADIUS	ROLLING CIRCUM.	ROLLING CIRCUM. INDEX	BAR HEIGHT 32NDS	BAR HEIGHT INCHES	FLAT PLATE (SQ. IN.)	MAX. LOAD & INFL. (LBS. @ PSI)
TUBELESS													
48X25.00-20	328057	10	B	20.50	25.0	48.5	21.4	143	-	32	1.00	315	6150@35
48X31.00-20	361984	14	B	26.00	31.0	48.5	21.7	144	-	32	1.00	350	7400@45

FLOTATION FREE ROLLING — HF-2



Designed to give better steering response and a smooth ride.

Front-tire flotation and control in soggy field conditions.

TIRE DIMENSIONS (IN.)												CONTACT AREA	
TIRE SIZE	MATERIAL NUMBER	LOAD INDEX	PLY RATING	SPEED SYMBOL RATING	DESIGN RIM WIDTH	OVERALL WIDTH	OVERALL DIA.	STATIC LOADED RADIUS	ROLLING CIRCUM.	BAR HEIGHT 32NDS	BAR HEIGHT INCHES	FLAT PLATE (SQ. IN.)	MAX. LOAD & INFL. (LBS. @ PSI)
TUBELESS													
48X25.00-20	360422	149	12	B	20.50	25.0	48.5	21.4	143	32	1.00	315	7150@45
48X31.00-20	360430	150	14	B	26.00	31.0	48.5	21.7	144	32	1.00	350	7400@45

¹ Compared to 45° tread pattern design.

 Addition from previous data book
 See General Farm Tire Information, Approved Rim Contours (pages 168-172) for a listing of approved rim contours by tire size.
 See Load & Inflation Tables (pages 92-163) for more details.

RADIAL FARM

BIAS FARM

FRONTS & IMPLEMENTS

FORESTRY & FLOTATION

DISCONTINUED

LOAD & INFLATION TABLES

GENERAL TIRE INFORMATION

WARRANTY

FLOTATION 23° DEEP TREAD — HF-3



Designed with rounded shoulders to help minimize soil disturbance while turning.

With Firestone's innovative 23° tread design, more of the bar grips the surface, making it ideal for farmers looking for increased traction while more efficiently transferring horsepower to the ground, saving both time and fuel¹.

RADIAL FARM

BIAS FARM

FRONTS & IMPLEMENTS

FORESTRY & FLOTATION

DISCONTINUED

LOAD & INFLATION TABLES

GENERAL TIRE INFORMATION

WARRANTY

TIRE DIMENSIONS (IN.)												CONTACT AREA	
TIRE SIZE	MATERIAL NUMBER	PLY RATING	SPEED SYMBOL RATING	DESIGN RIM WIDTH	OVERALL WIDTH	OVERALL DIA.	STATIC LOADED RADIUS	ROLLING CIRCUM.	ROLLING CIRCUM. INDEX	BAR HEIGHT 32NDS	BAR HEIGHT INCHES	FLAT PLATE (SQ. IN.)	MAX. LOAD & INFL. (LBS. @ PSI)
TUBELESS													
54X37.00-25	352055	12	B	32.00	37.0	56.3	25.8	172	-	61	1.91	474	8250@35
66X43.00-25	340693	10	B	36.00	41.5	67.8	30.3	202	-	74	2.31	625	9900@25
66X43.00-25	358312	16	B	36.00	41.5	67.8	30.3	202	-	74	2.31	625	13200@40
73X44.00-32	358835	16	B	36.00	43.2	74.0	32.5	219	-	77	2.41	730	15200@40
76X50.00-32	359866	16	B	44.00	48.6	78.5	36.1	233	-	80	2.50	965	16100@35
76X50.00-32	369702	20	B	44.00	48.6	78.5	36.1	233	-	80	2.50	965	18700@45

¹ Compared to 45° tread pattern design.

Addition from previous data book
 See General Farm Tire Information, Approved Rim Contours (pages 168-172) for a listing of approved rim contours by tire size.
 See Load & Inflation Tables (pages 92-163) for more details.

ALL NON-SKID (ANS) FARM — I-2

TIRE DIMENSIONS (IN.)												CONTACT AREA	
TIRE SIZE	MATERIAL NUMBER	PLY RATING	SPEED SYMBOL RATING	DESIGN RIM WIDTH	OVERALL WIDTH	OVERALL DIA.	STATIC LOADED RADIUS	ROLLING CIRCUM.	ROLLING CIRCUM. INDEX	BAR HEIGHT 32NDS	BAR HEIGHT INCHES	FLAT PLATE (SQ. IN.)	MAX. LOAD & INFL. (LBS. @ PSI)
TUBELESS													
13.50-16.1	325015	10	B	11.00	13.5	40.6	17.5	120	-	19	0.59	165	4940@40
16.5L-16.1	310514	6	B	14.00	16.3	40.8	17.5	116	-	19	0.59	175	3960@24

ALL NON-SKID TRACTOR — R-3

TIRE DIMENSIONS (IN.)												CONTACT AREA	
TIRE SIZE	MATERIAL NUMBER	PLY RATING	SPEED SYMBOL RATING	DESIGN RIM WIDTH	OVERALL WIDTH	OVERALL DIA.	STATIC LOADED RADIUS	ROLLING CIRCUM.	ROLLING CIRCUM. INDEX	BAR HEIGHT 32NDS	BAR HEIGHT INCHES	FLAT PLATE (SQ. IN.)	MAX. LOAD & INFL. (LBS. @ PSI)
TUBELESS													
30.5L-32	359904	14	A8	27.00	30.5	70.6	30.3	202	-	38	1.19	365	9900@22
9.5-24	306096	4	A8	8.00	9.4	39.8	18.5	119	-	14	0.44	75	1480@20
13.6-28	306193	6	A8	12.00	13.6	51.5	23.4	153	-	24	0.75	140	2830@22

CHAMPION GUIDE GRIP 4-RIB — F-2

TIRE DIMENSIONS (IN.)												CONTACT AREA	
TIRE SIZE	MATERIAL NUMBER	PLY RATING	SPEED SYMBOL RATING	DESIGN RIM WIDTH	OVERALL WIDTH	OVERALL DIA.	STATIC LOADED RADIUS	ROLLING CIRCUM.	ROLLING CIRCUM. INDEX	BAR HEIGHT 32NDS	BAR HEIGHT INCHES	FLAT PLATE (SQ. IN.)	MAX. LOAD & INFL. (LBS. @ PSI)
TUBELESS													
10.00-16	339865	8	A8	8.00	10.6	34.9	15.8	104	-	26	0.81	60	2340@44
10.00-16	357898	8	A8	8.00	10.6	34.9	15.8	104	-	26	0.81	60	2340@44
10.00-16	368750	10	A8	8.00	10.6	34.9	15.8	104	-	26	0.81	60	2600@52
11.00-16	357901	8	A8	10.00	12.2	37.8	17.1	113	-	29	0.91	71	2600@40
14L-16.1	365537	8	A8	11.00	14.00	38.8	17.1	114	-	51	1.28	100	3000@26

CHAMPION GUIDE GRIP 3-RIB — F-2

TIRE DIMENSIONS (IN.)												CONTACT AREA	
TIRE SIZE	MATERIAL NUMBER	PLY RATING	SPEED SYMBOL RATING	DESIGN RIM WIDTH	OVERALL WIDTH	OVERALL DIA.	STATIC LOADED RADIUS	ROLLING CIRCUM.	ROLLING CIRCUM. INDEX	BAR HEIGHT 32NDS	BAR HEIGHT INCHES	FLAT PLATE (SQ. IN.)	MAX. LOAD & INFL. (LBS. @ PSI)
TUBELESS													
7.50-20	352594	6	A8	5.50	7.9	35.8	16.3	106	-	26	0.81	48	1710@44
14L-16.1	354449	8	A8	11.00	14.0	38.8	17.1	114	-	41	1.28	100	3000@36
10.00-16	350877	8	A8	8.00	10.8	35.2	16.2	104	-	32	1.00	60	2340@44
11.00-16	350885	8	A8	10.00	12.4	38.1	17.5	113	-	35	1.09	71	2600@40

 Addition from previous data book

See General Farm Tire Information, Approved Rim Contours (pages 168-172) for a listing of approved rim contours by tire size.
See Load & Inflation Tables (pages 92-163) for more details.

CHAMPION HYDRO ND — R-1

RADIAL FARM

TIRE DIMENSIONS (IN.)												CONTACT AREA	
TIRE SIZE	MATERIAL NUMBER	LOAD INDEX	SPEED SYMBOL RATING	DESIGN RIM WIDTH	OVERALL WIDTH	OVERALL DIA.	STATIC LOADED RADIUS	ROLLING CIRCUM.	ROLLING CIRCUM. INDEX	BAR HEIGHT 32NDS	BAR HEIGHT INCHES	FLAT PLATE (SQ. IN.)	MAX. LOAD & INFL. (LBS. @ PSI)
TUBELESS													
380/85D24	373765	145	CREEP	12.00	15.0	49.4	21.2	141	-	47	1.47	268	6400@26
290/85D38	374785	132	-	10.00	11.5	57.9	26	171	-	43	1.34	205	4400@24

BIAS FARM

CHAMPION SPADE GRIP — R-2

FRONTS & IMPLEMENTS

TIRE DIMENSIONS (IN.)												CONTACT AREA	
TIRE SIZE	MATERIAL NUMBER	PLY RATING	SPEED SYMBOL RATING	DESIGN RIM WIDTH	OVERALL WIDTH	OVERALL DIA.	STATIC LOADED RADIUS	ROLLING CIRCUM.	ROLLING CIRCUM. INDEX	BAR HEIGHT 32NDS	BAR HEIGHT INCHES	FLAT PLATE (SQ. IN.)	MAX. LOAD & INFL. (LBS. @ PSI)
TUBELESS													
16.9-26	326712	10	A8	15.00	17.3	56.6	25.1	166	-	94	2.94	195	4540@28
18.4-26	358266	6	A8	16.00	18.4	57.8	26	168	-	100	3.13	230	3960@16
28L-26	358282	12	A8	25.00	28.1	65.9	29.4	192	-	109	3.41	390	7400@20
18.4-30	358274	6	A8	16.00	18.4	61.8	27.7	178	-	100	3.13	250	4180@16
18.4-38	343110	14	A8	16.00	18.4	69.8	32	205	-	100	3.13	260	7600@36
20.8-42	352918	14	A8	18.00	20.8	78.3	36	227	-	103	3.22	348	9100@32
23.1-34	311375	8	A8	20.00	23.1	73.6	34	215	-	109	3.41	375	6400@16
13.6-38	379885	6	A8	12.00	13.6	63.0	29.8	189	-	86	2.69	135	3300@22
18.4-34	311154	6	A8	16.00	18.4	65.8	29.7	195	-	100	3.13	255	4400@16
15.5-38	311219	6	A8	14.00	15.5	64.9	29.8	195	-	85	2.69	175	3520@20
18.4-38	311448	8	A8	16.00	18.4	69.8	31.7	2015	-	100	3.13	260	5360@20

FORESTRY & FLOTATION

DISCONTINUED

DESTINATION FARM — I-1

LOAD & INFLATION TABLES

TIRE DIMENSIONS (IN.)												CONTACT AREA	
TIRE SIZE	MATERIAL NUMBER	LOAD INDEX	SPEED SYMBOL RATING	DESIGN RIM WIDTH	OVERALL WIDTH	OVERALL DIA.	STATIC LOADED RADIUS	ROLLING CIRCUM.	ROLLING CIRCUM. INDEX	BAR HEIGHT 32NDS	BAR HEIGHT INCHES	FLAT PLATE (SQ. IN.)	MAX. LOAD & INFL. (LBS. @ PSI)
TUBELESS													
IF280/70R15	000410	128	D	8.00	10.6	30.5	13	92	-	11	0.34	78	3960@52
VF245/70R19.5	000555	134	D	7.50	9.4	33.4	15	100	-	19	0.59	70	4680@58
VF295/75R22.5	000554	145	D	8.25	10.6	40.1	17	121	-	19	0.59	105	6400@52
VF385/65R22.5	000582	158	D	11.75	15.1	42.7	18	128	-	23	0.72	144	9350@58
IF26585R15	000544	121	D	8.00	10.8	32.5	14	96	-	11	0.34	86	3200@35
VF255/70R22.5	000898	146	D	8.25	10.3	37.3	16.8	112	-	26	0.81	85	6600@75
VF445/65R22.5	000583	169	D	13.00	17.3	45.8	20	138	-	24	0.75	189	12800@64

GENERAL TIRE INFORMATION

WARRANTY

Addition from previous data book
 See General Farm Tire Information, Approved Rim Contours (pages 168-172) for a listing of approved rim contours by tire size.
 See Load & Inflation Tables (pages 92-163) for more details.

FARM IMPLEMENT — F-1

TIRE DIMENSIONS (IN.)												CONTACT AREA	MAX. LOAD & INFL. (LBS. @ PSI)
TIRE SIZE	MATERIAL NUMBER	PLY RATING	SPEED SYMBOL RATING	DESIGN RIM WIDTH	OVERALL WIDTH	OVERALL DIA.	STATIC LOADED RADIUS	ROLLING CIRCUM.	ROLLING CIRCUM. INDEX	BAR HEIGHT 32NDS	BAR HEIGHT INCHES	FLAT PLATE (SQ. IN.)	
TUBELESS													
11L-14	350028	8	B	8.00	10.8	29.4	13.1	87	-	8	0.25	77	2440@36
6.70-15	339296	4	B	4.50	6.6	27.5	12.2	82	-	7	0.22	39	1280@32
27X9.50-15	357804	8	B	7.00	9.4	27.5	12.6	81	-	10	0.31	53	1870@60
11L-16	359831	8	B	8.00	10.8	31.4	14.0	95	-	8	0.25	80	2680@36
12.5L-16	339474	8	B	10.00	12.3	33.1	15	100	-	8	0.25	110	3080@36
12.5L-16	339490	12	B	10.00	12.3	33.1	14.7	100	-	8	0.25	110	3960@52
14L-16.1	365520	12	B	11.00	14.0	37.0	16.5	101	-	12	0.38	136	4680@44

FARM TIRE — I-1

TIRE DIMENSIONS (IN.)												CONTACT AREA	MAX. LOAD & INFL. (LBS. @ PSI)
TIRE SIZE	MATERIAL NUMBER	PLY RATING	SPEED SYMBOL RATING	DESIGN RIM WIDTH	OVERALL WIDTH	OVERALL DIA.	STATIC LOADED RADIUS	ROLLING CIRCUM.	ROLLING CIRCUM. INDEX	BAR HEIGHT 32NDS	BAR HEIGHT INCHES	FLAT PLATE (SQ. IN.)	
TUBELESS													
21.5L-16.1	325848	14	B	18.00	21.8	43.5	19.3	120	-	14	0.44	252	7850@36

FARM SERVICE DIA — R-3

TIRE DIMENSIONS (IN.)												CONTACT AREA	MAX. LOAD & INFL. (LBS. @ PSI)
TIRE SIZE	MATERIAL NUMBER	PLY RATING	SPEED SYMBOL RATING	DESIGN RIM WIDTH	OVERALL WIDTH	OVERALL DIA.	STATIC LOADED RADIUS	ROLLING CIRCUM.	ROLLING CIRCUM. INDEX	BAR HEIGHT 32NDS	BAR HEIGHT INCHES	FLAT PLATE (SQ. IN.)	
TUBELESS													
6-12	344699	4	A6	5.00	6.1	22.2	10.3	66	-	11	0.34	-	600@28
6-14	344362	4	A6	5.00	6.1	24.2	11.2	72	-	10	0.31	-	660@28

FIELD & ROAD — R-1

TIRE DIMENSIONS (IN.)												CONTACT AREA	MAX. LOAD & INFL. (LBS. @ PSI)
TIRE SIZE	MATERIAL NUMBER	PLY RATING	SPEED SYMBOL RATING	DESIGN RIM WIDTH	OVERALL WIDTH	OVERALL DIA.	STATIC LOADED RADIUS	ROLLING CIRCUM.	ROLLING CIRCUM. INDEX	BAR HEIGHT 32NDS	BAR HEIGHT INCHES	FLAT PLATE (SQ. IN.)	
TUBELESS													
11.2-28	304743	4	A8	10.00	11.2	47.0	21.6	142	-	37	1.16	100	1760@18
9.5-32	304794	4	A8	8.00	9.5	48.9	22.7	147	-	36	1.13	90	1650@20
12.4-36	304816	4	A8	11.00	12.4	57.0	26.2	172	-	39	1.22	135	2270@16
13.6-36	304824	4	A8	12.00	13.6	59.1	27.9	179	-	41	1.28	160	2470@14
12.4-38	304921	6	A8	11.00	12.4	59.0	27.2	178	-	39	1.22	140	2910@24

 Addition from previous data book

See General Farm Tire Information, Approved Rim Contours (pages 168-172) for a listing of approved rim contours by tire size.
See Load & Inflation Tables (pages 92-163) for more details.

FLOTATION 23° — G-1

RADIAL FARM

TIRE DIMENSIONS (IN.)												CONTACT AREA	
TIRE SIZE	MATERIAL NUMBER	PLY RATING	SPEED SYMBOL RATING	DESIGN RIM WIDTH	OVERALL WIDTH	OVERALL DIA.	STATIC LOADED RADIUS	ROLLING CIRCUM.	ROLLING CIRCUM. INDEX	BAR HEIGHT 32NDS	BAR HEIGHT INCHES	FLAT PLATE (SQ. IN.)	MAX. LOAD & INFL. (LBS. @ PSI)
TUBELESS													
26X12.00-12	381772	8	A3	10.50	12.1	25.5	12	79	-	20	0.63	96	2745@42

BIAS FARM

FLOTATION 23° DEEP TREAD (LOGGER) — HF-3

TIRE DIMENSIONS (IN.)												CONTACT AREA	
TIRE SIZE	MATERIAL NUMBER	PLY RATING	SPEED SYMBOL RATING	DESIGN RIM WIDTH	OVERALL WIDTH	OVERALL DIA.	STATIC LOADED RADIUS	ROLLING CIRCUM.	ROLLING CIRCUM. INDEX	BAR HEIGHT 32NDS	BAR HEIGHT INCHES	FLAT PLATE (SQ. IN.)	MAX. LOAD & INFL. (LBS. @ PSI)
TUBELESS													
68X50.00-32	343137	16	A2	44.00	48.5	69.0	30	204	-	80	2.50	825	19400@35
73X44.00-32	343366	16	A2	36.00	42.0	74.3	32.5	219	-	77	2.41	730	24000@40

FRONTS & IMPLEMENTS

FLOTATION 23° EXTRA-DEEP TREAD LOGGER — HF-3

TIRE DIMENSIONS (IN.)												CONTACT AREA	
TIRE SIZE	MATERIAL NUMBER	PLY RATING	SPEED SYMBOL RATING	DESIGN RIM WIDTH	OVERALL WIDTH	OVERALL DIA.	STATIC LOADED RADIUS	ROLLING CIRCUM.	ROLLING CIRCUM. INDEX	BAR HEIGHT 32NDS	BAR HEIGHT INCHES	FLAT PLATE (SQ. IN.)	MAX. LOAD & INFL. (LBS. @ PSI)
TUBELESS													
66X43.00-26	354333	14	A2	36.00	41.5	70.7	33	213	-	109	3.41	625	19000@35
66X43.00-25	354325	14	A2	36.00	41.5	70.7	32.5	213	-	109	3.41	625	19400@35

FORESTRY & FLOTATION

DISCONTINUED

FLOTATION SUPER ALL TERRAIN — HF-1

TIRE DIMENSIONS (IN.)												CONTACT AREA	
TIRE SIZE	MATERIAL NUMBER	LOAD INDEX	SPEED SYMBOL RATING	DESIGN RIM WIDTH	OVERALL WIDTH	OVERALL DIA.	STATIC LOADED RADIUS	ROLLING CIRCUM.	ROLLING CIRCUM. INDEX	BAR HEIGHT 32NDS	BAR HEIGHT INCHES	FLAT PLATE (SQ. IN.)	MAX. LOAD & INFL. (LBS. @ PSI)
TUBELESS													
265/55D16.5	365350	93	A8	8.25	10.1	27.9	13	83	-	10	0.31	60	1430@23
320/55D16.5	365384	102	A8	9.75	12.3	29.7	13	87	-	11	0.34	77	1870@23
460/60D24	365418	128	A8	15.00	18.1	45.7	20	135	-	17	0.53	160	3960@23
380/70D19.5	365639	122	A8	11.75	14.9	40.3	18	119	-	16	0.50	133	3300@23

LOAD & INFLATION TABLES

GENERAL TIRE INFORMATION

WARRANTY

Addition from previous data book
 See General Farm Tire Information, Approved Rim Contours (pages 168-172) for a listing of approved rim contours by tire size.
 See Load & Inflation Tables (pages 92-163) for more details.

FORESTRY SPECIAL WITH CRC — LS2

TIRE DIMENSIONS (IN.)												CONTACT AREA	
TIRE SIZE	MATERIAL NUMBER	PLY RATING	SPEED SYMBOL RATING	DESIGN RIM WIDTH	OVERALL WIDTH	OVERALL DIA.	STATIC LOADED RADIUS	ROLLING CIRCUM.	ROLLING CIRCUM. INDEX	BAR HEIGHT 32NDS	BAR HEIGHT INCHES	FLAT PLATE (SQ. IN.)	MAX. LOAD & INFL. (LBS. @ PSI)
TUBELESS													
23.1-26	361798	10	A2	20.00	23.1	63.5	29	188	-	67	2.09	261	10000@25
28L-26	362494	14	A2	25.00	28.1	64.5	29.2	192	-	70	2.19	302	13200@30
16.9-30	361844	10	A2	15.00	16.9	59.2	27.3	178	-	61	1.91	162	8050@35
24.5-32	362704	14	A2	21.00	24.5	70.9	32.5	209	-	67	2.09	350	15200@35
24.5-32	000408	18	A2	21.00	24.5	70.9	33	209	-	70	2.19	350	16800@40
30.5L-32	371538	20	A2	27.00	30.5	74.0	33.2	219	-	72	2.25	378	18700@35
DH35.5LB32	371572	20	A2	31.00	35.5	79.2	35.6	235	-	81	2.53	641	22700@30

GUIDE GRIP 3-RIB — F-2

TIRE DIMENSIONS (IN.)												CONTACT AREA	
TIRE SIZE	MATERIAL NUMBER	LOAD INDEX	SPEED SYMBOL RATING	DESIGN RIM WIDTH	OVERALL WIDTH	OVERALL DIA.	STATIC LOADED RADIUS	ROLLING CIRCUM.	ROLLING CIRCUM. INDEX	BAR HEIGHT 32NDS	BAR HEIGHT INCHES	FLAT PLATE (SQ. IN.)	MAX. LOAD & INFL. (LBS. @ PSI)
TUBE TYPE													
5.00-15	375278	4	A8	3.00	5.1	25.6	11.7	76	-	12	0.38	19	715@44

IRRIGATION SPECIAL — R-1

TIRE DIMENSIONS (IN.)												CONTACT AREA	
TIRE SIZE	MATERIAL NUMBER	PLY RATING	SPEED SYMBOL RATING	DESIGN RIM WIDTH	OVERALL WIDTH	OVERALL DIA.	STATIC LOADED RADIUS	ROLLING CIRCUM.	ROLLING CIRCUM. INDEX	BAR HEIGHT 32NDS	BAR HEIGHT INCHES	FLAT PLATE (SQ. IN.)	MAX. LOAD & INFL. (LBS. @ PSI)
TUBE TYPE													
11.2-24	349984	4	-	10.00	11.2	43.1	20	130	-	32	1.00	90	3480@24

PERFORMER 85 — R-1W

TIRE DIMENSIONS (IN.)												CONTACT AREA	
TIRE SIZE	MATERIAL NUMBER	LOAD INDEX	SPEED SYMBOL RATING	DESIGN RIM WIDTH	OVERALL WIDTH	OVERALL DIA.	STATIC LOADED RADIUS	ROLLING CIRCUM.	ROLLING CIRCUM. INDEX	BAR HEIGHT 32NDS	BAR HEIGHT INCHES	FLAT PLATE (SQ. IN.)	MAX. LOAD & INFL. (LBS. @ PSI)
TUBELESS													
340/85R28	000550	127	D	12.00	13.9	51.2	23.0	154	39	52	1.63	-	3860@23
420/85R38	000598	144	D	15.00	17.2	66.1	29.8	199	44	62	1.94	255	6150@23

 Addition from previous data book

See General Farm Tire Information, Approved Rim Contours (pages 168-172) for a listing of approved rim contours by tire size.
See Load & Inflation Tables (pages 92-163) for more details.

POWER IMPLEMENT — I-3

RADIAL FARM

TIRE DIMENSIONS (IN.)												CONTACT AREA	
TIRE SIZE	MATERIAL NUMBER	PLY RATING	SPEED SYMBOL RATING	DESIGN RIM WIDTH	OVERALL WIDTH	OVERALL DIA.	STATIC LOADED RADIUS	ROLLING CIRCUM.	ROLLING CIRCUM. INDEX	BAR HEIGHT 32NDS	BAR HEIGHT INCHES	FLAT PLATE (SQ. IN.)	MAX. LOAD & INFL. (LBS. @ PSI)
TUBELESS													
12.5L-15	340561	8	B	10.00	12.5	33.3	15.0	101	-	22	0.69	110	3000@36
13.50-16.1	342688	8	B	11.00	15.0	41.1	17.8	124	-	23	0.72	166	4300@32
16.5L-16.1	340618	6	B	14.00	16.0	41.0	17.7	124	-	25	0.79	198	3960@24

BIAS FARM

RADIAL 23° — R-1W

FRONTS & IMPLEMENTS

TIRE DIMENSIONS (IN.)												CONTACT AREA	
TIRE SIZE	MATERIAL NUMBER	LOAD INDEX	SPEED SYMBOL RATING	DESIGN RIM WIDTH	OVERALL WIDTH	OVERALL DIA.	STATIC LOADED RADIUS	ROLLING CIRCUM.	ROLLING CIRCUM. INDEX	BAR HEIGHT 32NDS	BAR HEIGHT INCHES	FLAT PLATE (SQ. IN.)	MAX. LOAD & INFL. (LBS. @ PSI)
TUBELESS													
18.4R34	354740	139	B	16.00	18.8	65.1	28.8	194	44	49	1.53	305	5360@18
18.4R38	359823	146	B	16.00	18.8	69.1	30.8	206	45	49	1.53	325	6600@24
18.4R42	362212	153	B	16.00	18.8	73.1	32.8	218	46	49	1.53	335	8050@30

FORESTRY & FLOTATION

RADIAL 4000 — R-1W

DISCONTINUED

TIRE DIMENSIONS (IN.)												CONTACT AREA	
TIRE SIZE	MATERIAL NUMBER	LOAD INDEX	SPEED SYMBOL RATING	DESIGN RIM WIDTH	OVERALL WIDTH	OVERALL DIA.	STATIC LOADED RADIUS	ROLLING CIRCUM.	ROLLING CIRCUM. INDEX	BAR HEIGHT 32NDS	BAR HEIGHT INCHES	FLAT PLATE (SQ. IN.)	MAX. LOAD & INFL. (LBS. @ PSI)
TUBELESS													
360/70R20	365843	129	B	11.00	14.1	41.4	19	126	-	40	1.25	-	4080@35

LOAD & INFLATION TABLES

RADIAL 9000 — R-1W

GENERAL TIRE INFORMATION

TIRE DIMENSIONS (IN.)												CONTACT AREA	
TIRE SIZE	MATERIAL NUMBER	LOAD INDEX	SPEED SYMBOL RATING	DESIGN RIM WIDTH	OVERALL WIDTH	OVERALL DIA.	STATIC LOADED RADIUS	ROLLING CIRCUM.	ROLLING CIRCUM. INDEX	BAR HEIGHT 32NDS	BAR HEIGHT INCHES	FLAT PLATE (SQ. IN.)	MAX. LOAD & INFL. (LBS. @ PSI)
TUBELESS													
540/65R24	359165	140	B	16.00	2.05	52.5	23.3	157	40	55	1.72	280	5520@23
290/95R34	359211	131	B	9.00	11.7	55.8	25.9	168	41	49	1.53	155	4300@35
320/85R38	360074	138	B	10.00	12.5	59.7	27.6	180	42	51	1.59	165	5200@41
230/95R48	356263	134	B	7.00	9.0	65.2	30.8	197	44	49	1.53	125	4680@52

WARRANTY

Addition from previous data book
 See General Farm Tire Information, Approved Rim Contours (pages 168-172) for a listing of approved rim contours by tire size.
 See Load & Inflation Tables (pages 92-163) for more details.

RADIAL ALL NON-SKID (ANS) — R-3

TIRE DIMENSIONS (IN.)												CONTACT AREA	MAX. LOAD & INFL. (LBS. @ PSI)
TIRE SIZE	MATERIAL NUMBER	LOAD INDEX	SPEED SYMBOL RATING	DESIGN RIM WIDTH	OVERALL WIDTH	OVERALL DIA.	STATIC LOADED RADIUS	ROLLING CIRCUM.	ROLLING CIRCUM. INDEX	BAR HEIGHT 32NDS	BAR HEIGHT INCHES	FLAT PLATE (SQ. IN.)	
TUBELESS													
800/60R32	379171	175	B	27.00	32.6	70.3	32	210	45	38	1.19	387	15200@46

RADIAL ALL TRACTION 23° — R-1W

TIRE DIMENSIONS (IN.)												CONTACT AREA	MAX. LOAD & INFL. (LBS. @ PSI)
TIRE SIZE	MATERIAL NUMBER	LOAD INDEX	SPEED SYMBOL RATING	DESIGN RIM WIDTH	OVERALL WIDTH	OVERALL DIA.	STATIC LOADED RADIUS	ROLLING CIRCUM.	ROLLING CIRCUM. INDEX	BAR HEIGHT 32NDS	BAR HEIGHT INCHES	FLAT PLATE (SQ. IN.)	
TUBELESS													
23.1R34	352969	151	B	20.00	23.1	71.2	31.1	210	45	52	1.63	425	7600@18
480/85R34	362392	149	B	16.00	18.8	65.4	28.8	194	44	50	1.56	320	7150@23
520/85R34	369600	165	B	18.00	21.2	76.2	34.3	228	47	52	1.63	420	11400@41
IF520/85R34	380395	168	B	18.00	21.3	69.0	30.0	202	45	52	1.63	336	12300@41
420/85R38	379120	144	B	15.00	17.2	66.5	29.9	198	44	49	1.53	255	6150@23

RADIAL ALL TRACTION DT — R-1W

TIRE DIMENSIONS (IN.)												CONTACT AREA	MAX. LOAD & INFL. (LBS. @ PSI)
TIRE SIZE	MATERIAL NUMBER	LOAD INDEX	SPEED SYMBOL RATING	DESIGN RIM WIDTH	OVERALL WIDTH	OVERALL DIA.	STATIC LOADED RADIUS	ROLLING CIRCUM.	ROLLING CIRCUM. INDEX	BAR HEIGHT 32NDS	BAR HEIGHT INCHES	FLAT PLATE (SQ. IN.)	
TUBELESS													
320/85R24	362681	122	B	10.00	12.6	45.1	20.4	137	37	51	1.59	150	3300@23
340/85R24	362698	125	B	11.00	13.5	47.0	21.2	143	38	53	1.66	165	3640@23
750/65R26	376791	166	B	25.00	29.2	64.6	28.9	192	-	67	2.09	453	11700@35
480/70R28	351563	140	B	15.00	19.1	56.5	25.5	168	41	55	1.72	245	5520@23
600/65R28	360058	147	B	18.00	23.0	58.7	26.1	174	42	65	2.03	330	6800@23
600/70R28	377522	161	B	18.00	23.5	60.6	27	178	42	65	2.03	355	10200@41
VF600/70R28	001602	173	B	21.00	23.7	61.1	26.7	181	-	65	2.03	389	14300@41
480/80R30	362732	145	B	15.00	18.9	60.6	27.1	179	42	62	1.94	290	6400@23
IF620/75R30	377535	164	D	21.00	24.6	66.6	28.4	198	44	67	2.09	403	11000@23
800/65R32	357685	172	B	27.00	32.1	73.3	32.7	216	46	74	2.31	575	13900@35
IF710/70R42	373697	179	B	25.00	29.4	80.2	35.3	240	48	74	2.31	59	17100@35

 Addition from previous data book

See General Farm Tire Information, Approved Rim Contours (pages 168-172) for a listing of approved rim contours by tire size.
See Load & Inflation Tables (pages 92-163) for more details.

RADIAL ALL TRACTION RC — R-1W

RADIAL FARM

TIRE DIMENSIONS (IN.)												CONTACT AREA	MAX. LOAD & INFL. (LBS. @ PSI)
TIRE SIZE	MATERIAL NUMBER	LOAD INDEX	SPEED SYMBOL RATING	DESIGN RIM WIDTH	OVERALL WIDTH	OVERALL DIA.	STATIC LOADED RADIUS	ROLLING CIRCUM.	ROLLING CIRCUM. INDEX	BAR HEIGHT 32NDS	BAR HEIGHT INCHES	FLAT PLATE (SQ. IN.)	
TUBELESS													
IF380/90R46	000629	168	D	13.00	15.7	73.3	33.7	220	46	57	1.79	273	12300@64
VF380/90R46	380412	173	D	13.00	15.7	73.3	33.4	220	46	57	1.79	303	14300@64

BIAS FARM

RADIAL CHAMPION SPADE GRIP — R-2

FRONTS & IMPLEMENTS

TIRE DIMENSIONS (IN.)												CONTACT AREA	MAX. LOAD & INFL. (LBS. @ PSI)
TIRE SIZE	MATERIAL NUMBER	LOAD INDEX	SPEED SYMBOL RATING	DESIGN RIM WIDTH	OVERALL WIDTH	OVERALL DIA.	STATIC LOADED RADIUS	ROLLING CIRCUM.	ROLLING CIRCUM. INDEX	BAR HEIGHT 32NDS	BAR HEIGHT INCHES	FLAT PLATE (SQ. IN.)	
TUBELESS													
18.4R28	352748	141	A8	16.00	18.4	61.0	27	180	-	100	3.13	250	5680@24
16.9R30	359386	141	A8	15.00	17.2	60.2	27.3	179	-	94	2.94	235	5680@30
18.4R38	353140	146	A8	16.00	18.4	69.9	31.6	208	-	100	3.13	290	6600@24

FORESTRY & FLOTATION

RADIAL DEEP TREAD 23° — R-1W

DISCONTINUED

TIRE DIMENSIONS (IN.)												CONTACT AREA	MAX. LOAD & INFL. (LBS. @ PSI)
TIRE SIZE	MATERIAL NUMBER	LOAD INDEX	SPEED SYMBOL RATING	DESIGN RIM WIDTH	OVERALL WIDTH	OVERALL DIA.	STATIC LOADED RADIUS	ROLLING CIRCUM.	ROLLING CIRCUM. INDEX	BAR HEIGHT 32NDS	BAR HEIGHT INCHES	FLAT PLATE (SQ. IN.)	
TUBELESS													
800/70R38	378525	181	B	25.00	31.3	81.9	36	243	48	74	2.31	580	18200@41
480/80R38	362749	149	B	15.00	18.9	69.1	31.4	206	45	63	1.97	350	7150@23
IF800/70R38CFO	000928	184	B	27.00	33.2	80.2	36.6	243	48	74	2.31	687	19800@35
IF850/75R42	376162	186	B	30.00	36.6	92.3	40	272	50	78	2.44	872	20900@23
480/80R46	362256	158	B	16.00	19.1	77.2	35.4	231	47	63	1.97	370	9350@35
IF480/80R46	004451	164	B	16.00	19.5	77.5	35.2	232	47	63	1.97	414	11000@35
VF480/80R46	009134	169	B	16.00	19.5	77.5	34.9	232	47	63	1.97	443	12800@35

LOAD & INFLATION TABLES

RANCHER — G-1

GENERAL TIRE INFORMATION

TIRE DIMENSIONS (IN.)												CONTACT AREA	MAX. LOAD & INFL. (LBS. @ PSI)
TIRE SIZE	MATERIAL NUMBER	PLY RATING	SPEED SYMBOL RATING	DESIGN RIM WIDTH	OVERALL WIDTH	OVERALL DIA.	STATIC LOADED RADIUS	ROLLING CIRCUM.	ROLLING CIRCUM. INDEX	BAR HEIGHT 32NDS	BAR HEIGHT INCHES	FLAT PLATE (SQ. IN.)	
TUBELESS													
8.0/75-15	361941	6	A6	6.50	7.8	27.0	13	83	28	25	0.78	-	1760@36

WARRANTY

Addition from previous data book
 See General Farm Tire Information, Approved Rim Contours (pages 168-172) for a listing of approved rim contours by tire size.
 See Load & Inflation Tables (pages 92-163) for more details.

RIB IMPLEMENT — I-1

TIRE DIMENSIONS (IN.)												CONTACT AREA	
TIRE SIZE	MATERIAL NUMBER	PLY RATING	SPEED SYMBOL RATING	DESIGN RIM WIDTH	OVERALL WIDTH	OVERALL DIA.	STATIC LOADED RADIUS	ROLLING CIRCUM.	ROLLING CIRCUM. INDEX	BAR HEIGHT 32NDS	BAR HEIGHT INCHES	FLAT PLATE (SQ. IN.)	MAX. LOAD & INFL. (LBS. @ PSI)
TUBE TYPE													
5.00-15	375346	4	B	3.00	5.1	25.2	11.5	73	-	6	0.19	26	965@36
31X13.50-15	008554	8	B	10.00	13.8	30.8	13.8	84	-	12	0.38	105	2600@45

SUPER ALL TRACTION 23° — R-1

TIRE DIMENSIONS (IN.)												CONTACT AREA	
TIRE SIZE	MATERIAL NUMBER	PLY RATING	SPEED SYMBOL RATING	DESIGN RIM WIDTH	OVERALL WIDTH	OVERALL DIA.	STATIC LOADED RADIUS	ROLLING CIRCUM.	ROLLING CIRCUM. INDEX	BAR HEIGHT 32NDS	BAR HEIGHT INCHES	FLAT PLATE (SQ. IN.)	MAX. LOAD & INFL. (LBS. @ PSI)
TUBELESS													
30.5L-32	344087	12	A8	27.00	30.1	71.6	32	212	-	54	1.69	400	9350@20
18.4-34	343676	12	A8	16.00	19.3	65.4	29	190	-	50	1.56	300	6600@32
30.5L-32	351067	14	A8	27.00	30.1	71.6	32.0	212	-	54	1.69	450	9900@22
20.8-38	343633	10	A8	18.00	22.0	72.1	32.4	212	-	51	1.59	380	6950@22
23.1-34	344109	8	A8	20.00	23.8	71.6	31.9	210	-	53	1.66	420	6400@16
12.4-38	355577	14	A8	11.00	12.4	59.6	26.8	180	-	45	1.41	145	4770@56
20.8-42	352888	14	A8	18.00	22.0	76.2	34.7	224	-	52	1.63	400	9100@32
TUBE TYPE													
28L-26	351938	14	A8	25.00	28.1	63.6	29	188	-	57	1.78	415	8250@24
20.8-42	343668	10	-	18.00	22.0	76.2	35	224	-	52	1.63	400	7400@22
18.4-42	343641	10	A8	16.00	19.3	73.5	33.3	217	-	50	1.56	345	6600@26

SUPER ALL TRACTION II 23° — R-1

TIRE DIMENSIONS (IN.)												CONTACT AREA	
TIRE SIZE	MATERIAL NUMBER	PLY RATING	SPEED SYMBOL RATING	DESIGN RIM WIDTH	OVERALL WIDTH	OVERALL DIA.	STATIC LOADED RADIUS	ROLLING CIRCUM.	ROLLING CIRCUM. INDEX	BAR HEIGHT 32NDS	BAR HEIGHT INCHES	FLAT PLATE (SQ. IN.)	MAX. LOAD & INFL. (LBS. @ PSI)
TUBELESS													
200/85D14	365571	88	A8	7.00	7.7	27.4	12	82	-	32	1.00	48	1230@23
250/85D16.5	365401	102	A8	8.25	9.8	33.0	15	99	-	40	1.25	69	1870@23
9.5-24	371351	6	A8	8.00	9.5	41.2	18.9	123	-	40	1.25	84	1870@30
11.2-24	365163	4	A8	10.00	11.2	43.4	19.8	128	-	41	1.28	103	1650@18
12.4-28	365452	6	A8	11.00	12.4	49.6	22.6	147	-	43	1.34	131	2540@24
13.6-28	365265	6	A8	12.00	13.6	51.6	23.4	153	-	44	1.38	153	2830@22
16.9-28	365469	6	A8	15.00	16.9	56.5	25.4	167	-	47	1.47	221	3640@18
16.9-30	365282	6	A8	15.00	16.9	58.5	26.4	173	-	47	1.47	228	3740@18
18.4-30	365486	8	A8	16.00	18.4	61.1	27	181	-	49	1.53	275	4800@20
18.4-34	367203	8	A8	16.00	18.4	65.1	29	193	-	49	1.53	291	5080@20

 Addition from previous data book

See General Farm Tire Information, Approved Rim Contours (pages 168-172) for a listing of approved rim contours by tire size.
See Load & Inflation Tables (pages 92-163) for more details.

SUPER ALL TRACTION FWD — R-1

RADIAL FARM

BIAS FARM

TIRE DIMENSIONS (IN.)												CONTACT AREA	MAX. LOAD & INFL. (LBS. @ PSI)
TIRE SIZE	MATERIAL NUMBER	PLY RATING	SPEED SYMBOL RATING	DESIGN RIM WIDTH	OVERALL WIDTH	OVERALL DIA.	STATIC LOADED RADIUS	ROLLING CIRCUM.	ROLLING CIRCUM. INDEX	BAR HEIGHT 32NDS	BAR HEIGHT INCHES	FLAT PLATE (SQ. IN.)	
TUBELESS													
14.9-26	343897	10	A8	13.00	14.8	52.4	23.5	154	-	48	1.50	170	4080@32
16.9-26	343900	10	A8	15.00	17.3	54.8	24.6	161	-	49	1.53	220	4540@28
14.9-28	343935	10	A8	13.00	15.2	54.6	24.9	161	-	48	1.50	175	4180@32
14.9-30	343951	10	A8	13.00	15.2	56.1	25.8	167	-	47	1.47	185	4300@32

SUPER ALL TRACTION DUPLEX — NHS

FRONTS & IMPLEMENTS

TIRE DIMENSIONS (IN.)												CONTACT AREA	MAX. LOAD & INFL. (LBS. @ PSI)
TIRE SIZE	MATERIAL NUMBER	LOAD INDEX	SPEED SYMBOL RATING	DESIGN RIM WIDTH	OVERALL WIDTH	OVERALL DIA.	STATIC LOADED RADIUS	ROLLING CIRCUM.	ROLLING CIRCUM. INDEX	BAR HEIGHT 32NDS	BAR HEIGHT INCHES	FLAT PLATE (SQ. IN.)	
TUBELESS													
215/65D14	365588	103	A8	7.00	8.3	25.0	11	74	-	17	0.53	44	1980@52

FORESTRY & FLOTATION

TRACTION FIELD & ROAD — R-1

DISCONTINUED

TIRE DIMENSIONS (IN.)												CONTACT AREA	MAX. LOAD & INFL. (LBS. @ PSI)
TIRE SIZE	MATERIAL NUMBER	PLY RATING	SPEED SYMBOL RATING	DESIGN RIM WIDTH	OVERALL WIDTH	OVERALL DIA.	STATIC LOADED RADIUS	ROLLING CIRCUM.	ROLLING CIRCUM. INDEX	BAR HEIGHT 32NDS	BAR HEIGHT INCHES	FLAT PLATE (SQ. IN.)	
TUBELESS													
8.3-24	351644	4	A8	7.00	8.3	38.9	18.1	117	-	38	1.19	63	1230@22
11.2-24	351725	6	A8	10.00	11.2	43.0	20.0	129	-	43	1.34	96	2090@26
13.6-28	361917	12	A8	12.00	13.6	51.5	23.6	153	-	47	1.47	145	4180@42
12.4-42	355097	6	A8	9.00	11.6	63.1	29.8	188	-	45	1.41	160	3080@24
TUBE TYPE													
14.9-26	345288	6	A8	13.00	14.9	52.0	23.5	153	-	48	1.50	166	3080@20
16.9-26	355119	6	A8	15.00	16.9	54.0	24.2	160	-	48	1.50	206	3520@18
23.1-30	338613	8	A8	20.00	23.1	67.4	29.8	197	-	53	1.66	383	6000@16
9.5-36	338443	4	A8	8.00	9.5	53.0	25.1	158	-	40	1.25	95	1760@20
13.6-38	338036	4	A8	12.00	13.6	61.5	28.4	184	-	47	1.47	168	2540@14
14.9-38	338516	6	A8	13.00	14.9	64.0	29.5	190	-	48	1.50	200	3740@20
16.9-38	338141	6	A8	15.00	16.9	66.3	30.4	198	-	49	1.53	252	4180@18
9.5-42	338532	6	A8	8.00	9.5	59.0	28.1	176	-	45	1.41	100	2400@30

LOAD & INFLATION TABLES

GENERAL TIRE INFORMATION

WARRANTY

Addition from previous data book
 See General Farm Tire Information, Approved Rim Contours (pages 168-172) for a listing of approved rim contours by tire size.
 See Load & Inflation Tables (pages 92-163) for more details.

TURF & FIELD — G-2

TIRE DIMENSIONS (IN.)													CONTACT AREA	MAX. LOAD & INFL. (LBS. @ PSI)
TIRE SIZE	MATERIAL NUMBER	PLY RATING	SPEED SYMBOL RATING	DESIGN RIM WIDTH	OVERALL WIDTH	OVERALL DIA.	STATIC LOADED RADIUS	ROLLING CIRCUM.	ROLLING CIRCUM. INDEX	BAR HEIGHT 32NDS	BAR HEIGHT INCHES	FLAT PLATE (SQ. IN.)		
TUBELESS														
20X8.00-10	381755	4	A3	6.00	7.5	19.9	9	58	-	8	0.25	-	910@24	
23X8.50-12	381789	4	A3	7.00	8.5	23.2	10	69	-	10	0.31	-	1100@22	
23X10.50-12	381738	4	A3	8.50	10.0	21.0	10	69	-	11	0.34	-	1320@20	
24X8.50-12	381721	4	A3	7.00	8.6	23.6	10	70	-	11	0.34	-	1120@22	
25X8.50-14	381687	4	A3	7.00	8.5	25.4	11	72	-	11	0.34	-	1320@22	
25X8.50-14	381704	6	A3	7.00	8.4	25.5	11	72	-	11	0.34	-	1650@32	
27X8.50-15	381670	4	A3	7.00	8.6	27.1	12	77	-	11	0.34	-	1625@30	
24X8.50-12	381721	4	A3	7.00	8.6	23.6	10	70	-	11	0.34	-	1120@22	

- RADIAL FARM
- BIAS FARM
- FRONTS & IMPLEMENTS
- FORESTRY & FLOTATION
- DISCONTINUED
- LOAD & INFLATION TABLES
- GENERAL TIRE INFORMATION
- WARRANTY

Addition from previous data book

See General Farm Tire Information, Approved Rim Contours (pages 168-172) for a listing of approved rim contours by tire size.
See Load & Inflation Tables (pages 92-163) for more details.

FOR RIM AND WHEEL LOAD INFORMATION, SEE IMPORTANT NOTES ON PAGES 168-172.

LOAD & INFLATION TABLES

TABLE	PAGES	DESCRIPTION
A	90-97	Radial Ply Agricultural Tractor Drive Wheel Tires
B	98-117	Metric Radial Ply Agricultural Tractor Drive Wheel Tires
C	118-125	AD ₂ IF Load Designation for Radial Agricultural Drive Wheel Tires
C2	126-129	AD ₂ VF Load Designation for Radial Agricultural Drive Wheel Tires
C3	130-131	AD ₂ IF and VF Load for Radial Implement Tires
E	132-135	Diagonal (Bias) Ply Agricultural Tractor Drive Wheel Tires — Tires Used as Singles
F1	136-137	Radial Ply Agricultural Drive Wheel Tires Used on Agricultural Harvesting Equipment in Cyclic Loading Field Service and Road Transport (Excluding Hillside Combines) — Tires Used as Singles
F2	138	IF CFO Radial Ply Agricultural Drive Wheel Tires Used on Agricultural Harvesting Equipment in Cyclic Loading Field Service and Road Transport (Excluding Hillside Combines) — Tires Used as Singles
F3	139-140	Diagonal (Bias) Ply Agricultural Drive Wheel Tires Used on Agricultural Harvesting Equipment in Cyclic Loading Field Service and Road Transport (Excluding Hillside Combines) — Tires Used as Singles
F4	141	VF CFO Radial Ply Agricultural Drive Wheel Tires Used on Agricultural Harvesting Equipment In Cyclic Loading Field Service and Road Transport (Excluding Hillside Combines) — Tires Used as Singles
G	142	Diagonal (Bias) Ply Agricultural R-4 Drive Wheel Tires Used on Industrial Tractors — Tires Used as Singles Without Sustained High Torque
H	143-144	High Flotation Tires Used in Agricultural, Logging and Off-the-Road Service
H1	145	High Flotation Tires Used in Logging Service
I	146	Diagonal (Bias) Ply Log Skidder Drive Wheel Tires Used in Logging or Forestry Service Other Than on Cable or Grapple Skidders — Tires Used as Singles
J	147	Diagonal (Bias) Ply Log Skidder Drive Wheel Tires Used on Cable or Grapple Skidders — Tires Used as Singles
K	148	Metric Forestry Tires Used in Agricultural, Logging and Off-the-Road Service
L	149-150	Diagonal (Bias) Ply Agricultural Tractor Steering Wheel Tires Used in Field Service (Including Hillside Combines)
M	151-152	Diagonal (Bias) Ply Agricultural Implement Tires
N	153	Diagonal (Bias) Ply Low Section Height Implement
O	154	Farm Implement Highway Special (F1) Tires for Towed Highway and Agricultural Service
P	155	Irrigation Tires at Creep Speed
Q	156	Special Application I-3 Implement Tires — All Traction Utility
R	157	Duplex Farm Tires
S	158	Tires Used in Skid Steer/Mini-Loader Aerial Lift Service
S1	159	Smaller-Size High Flotation Tires for Agricultural and Skid Steer/Mini-Loader Service
S2	160	Tires Used in Aerial Lift Applications
T	161	Agricultural Tractor Drive Wheel Tires for Small Tractors
U	162	Tires for Utility Vehicles and Lawn and Garden Tractors
V	163	Special Application I-3 Implement Tires — Super Traction Loader

RADIAL FARM

BIAS FARM

FRONTS & IMPLEMENTS

FORESTRY & FLOTATION

DISCONTINUED

LOAD & INFLATION TABLES

GENERAL TIRE INFORMATION

WARRANTY

FOR RIM AND WHEEL LOAD INFORMATION, SEE IMPORTANT NOTES ON PAGES 168-172.

TABLE A – RADIAL PLY AGRICULTURAL TRACTOR DRIVE WHEEL TIRES

TIRE TYPE NOMENCLATURE		MAX SPEED	
TRA	TIRE TYPE	A8/B	D
R-1	Drive Wheel, Regular Tread	30 mph	65 km/h
R-1W	Drive Wheel, Wet Traction Tread	30 mph	65 km/h
R-2	Cane & Rice, Drive Wheel, Deep Tread	25 mph	-

BASIC TIRE LOAD RATINGS FOR TIRE SELECTION METRIC ENGLISH UNITS OF MEASURE (kg@kPa)

TIRE SIZE	INFLATION		LOAD LIMITS AT VARIOUS COLD INFLATION PRESSURES													
	kPa	Symbol	40	60	70	80	100	110	120	140	150	160	180	190	210	250
LOAD LIMITS IN KG., INFLATION PRESSURE IN kPa																
*7.50R16		LI							84			89			94	98
	SINGLES		265	307	355	387	425	462	500	530	560	580	615	650	670	750
	DUALS		230	270	310	340	370	410	440	470	490	510	540	570	590	660
	TRIPLES		220	250	290	320	350	380	410	430	460	480	500	530	550	620
**7.50R18		LI							85			91			96	99
	SINGLES		280	325	375	412	450	487	515	560	580	615	650	670	710	900
	DUALS		250	290	320	360	400	420	450	490	510	540	570	90	620	790
	TRIPLES		230	270	310	340	370	400	420	460	480	500	530	550	580	740
12.4R46		LI							125			125			129	133
	SINGLES		730	880	980	1090	1180	1285	1400	1500	1550	1650	1700	1800	1850	2060
	DUALS		640	770	860	960	1040	1130	1230	1320	1360	1450	1500	1580	1630	1810
	TRIPLES		600	720	800	890	970	1050	1150	1230	1270	1350	1390	1480	1520	1690
12.4R54		LI							122			128			133	137
	SINGLES		800	950	1090	1215	1320	1400	1500	1600	1700	1800	1900	2000	2060	2300
	DUALS		700	840	960	1070	1160	1230	1320	1410	1500	1580	1670	1760	1810	2020
	TRIPLES		660	780	890	1000	1080	1150	1230	1310	1390	1480	1560	1640	1690	1890
13.6R28		LI							117			123			126	
	SINGLES		670	800	900	1000	1090	1180	1285	1360	1450	1550	1600	1650	1700	
	DUALS		590	700	790	880	960	1040	1130	1200	1280	1360	1410	1450	1500	
	TRIPLES		550	660	740	820	890	970	1050	1120	1190	1270	1310	1350	1390	
14.9R26		LI							121			127			132	
	SINGLES		775	925	1030	1150	1250	1360	1450	1550	1650	1750	1800	1900	2000	
	DUALS		680	810	910	1010	1100	1200	1280	1360	1450	1540	1580	1670	1760	
	TRIPLES		640	760	840	940	1030	1120	1190	1270	1350	1440	1480	1560	1640	
14.9R28		LI							122			128			133	
	SINGLES		800	950	1060	1180	1320	1400	1500	1600	1700	1800	1900	1950	2060	
	DUALS		700	840	930	1040	1160	1230	1320	1410	1500	1580	1670	1720	1810	
	TRIPLES		660	780	870	970	1080	1150	1230	1310	1390	1480	1560	1600	1690	
14.9R30		LI							123			129			134	
	SINGLES		825	975	1120	1215	1360	1450	1550	1650	1750	1850	1950	2000	2120	
	DUALS		730	860	990	1070	1200	1280	1360	1450	1540	1630	1730	1760	1870	
	TRIPLES		680	800	920	1000	1120	1190	1270	1350	1440	1520	1600	1640	1740	

FOR RIM AND WHEEL LOAD INFORMATION, SEE IMPORTANT NOTES ON PAGES 168-172.

RADIAL FARM
BIAS FARM
FRONTS & IMPLEMENTS
FORESTRY & FLOTATION
DISCONTINUED
LOAD & INFLATION TABLES
GENERAL TIRE INFORMATION
WARRANTY

TABLE A – RADIAL PLY AGRICULTURAL TRACTOR DRIVE WHEEL TIRES

BASIC TIRE LOAD RATINGS FOR TIRE SELECTION

ENGLISH UNITS OF MEASURE (lbs@psi)

TIRE SIZE	INFLATION		LOAD LIMITS AT VARIOUS COLD INFLATION PRESSURES														
	psi		6	8	10	12	14	16	18	20	22	24	26	28	30	36	
	Symbol								*			**			***	****	
LOAD LIMITS IN LBS., INFLATION PRESSURE IN PSI																	
14.9R34		LI															
	SINGLES		1930	2270	2600	2910	3200	3420	3640	3860	4080	4300	4540	4680	4940	5520	
	DUALS		1700	2000	2290	2560	2820	3010	3200	3400	3590	3780	4000	4120	4350	4860	
	TRIPLES		1580	1860	2130	2390	2620	2800	2980	3170	3350	3530	3720	3840	4050	4530	
14.9R46		LI															
	SINGLES		2270	2680	3080	3420	3740	3960	4300	4540	4800	5080	5360	5520	5840	6400	
	DUALS		2000	2360	2710	3010	3290	3480	3780	4000	4220	4470	4720	4860	5140	5630	
	TRIPLES		1860	2200	2530	2800	3070	3250	3530	3720	3940	4170	4400	4530	4790	5250	
15.5R38		LI															
	SINGLES		1930	2270	2600	2910	3200	3420	3640								
	DUALS		1700	2000	2290	2560	2820	3010	3200								
	TRIPLES		1580	1860	2130	2390	2620	2800	2980								
16.9R24		LI															
	SINGLES		1980	2340	2680	3000	3300	3520	3740	4080	4300	4680					
	DUALS		1740	2060	2360	2640	2900	3100	3290	3590	3780	4120					
	TRIPLES		1620	1920	2200	2460	2710	2890	3070	3350	3530	3840					
16.9R26		LI															
	SINGLES		2040	2470	2760	3060	3420	3640	3960	4180	4400	4800					
	DUALS		1800	2170	2430	2710	3010	3200	3480	3680	3870	4220					
	TRIPLES		1670	2030	2260	2530	2800	2980	3250	3430	3610	3940					
16.9R28		LI															
	SINGLES		2150	2540	2910	2600	3250	3740	4080	4300	4540	4940					
	DUALS		1890	2240	2560	2290	3100	3290	3590	3780	4000	4350					
	TRIPLES		1760	2080	2390	2130	2890	3070	3350	3530	3720	4050					
16.9R30		LI															
	SINGLES		2200	2600	3000	3300	3640	3860	4180	4400	4680	5080	5200	5360	5680	6150	
	DUALS		1940	2290	2640	2900	3200	3400	3680	3870	4120	4470	4580	4720	5000	5410	
	TRIPLES		1800	2130	2460	2710	2980	3170	3430	3610	3840	4170	4260	4400	4660	5040	
16.9R38		LI															
	SINGLES		2470	2910	3300	3740	4080	4400	4680	4940	5360	5680					
	DUALS		2170	2560	2900	3290	3590	3870	4120	4350	4720	5000					
	TRIPLES		2030	2390	2710	3070	3350	3610	3840	4050	4400	4660					
18.4R26		LI															
	SINGLES		2470	2910	3300	3740	4080	4400	4680	4940	5360	5520					
	DUALS		2170	2560	2900	3290	3590	3870	4120	4350	4720	4860					
	TRIPLES		2030	2390	2710	3070	3350	3610	3840	4050	4400	4530					
18.4R28		LI															
	SINGLES		2540	3000	3420	3860	4180	4540	4800	5200	5520	4680	6000	6400	6600		
	DUALS		2240	2640	3010	3400	3680	4000	4220	4580	4860	5000	5280	5630	5810		
	TRIPLES		2080	2460	2800	3170	3430	3720	3940	4260	4530	4660	4920	5250	5410		

FOR RIM AND WHEEL LOAD INFORMATION, SEE IMPORTANT NOTES ON PAGES 168-172.

RADIAL FARM

BIAS FARM

FRONTS & IMPLEMENTS

FORESTRY & FLOTATION

DISCONTINUED

LOAD & INFLATION TABLES

GENERAL TIRE INFORMATION

WARRANTY

TABLE A – RADIAL PLY AGRICULTURAL TRACTOR DRIVE WHEEL TIRES

BASIC TIRE LOAD RATINGS FOR TIRE SELECTION METRIC UNITS OF MEASURE (kg@kPa)

TIRE SIZE	INFLATION		LOAD LIMITS AT VARIOUS COLD INFLATION PRESSURES													
	kPa		40	60	70	80	100	110	120	140	150	160	180	190	210	250
	Symbol								*			**			***	****
LOAD LIMITS IN KG., INFLATION PRESSURE IN kPa																
14.9R34		LI							125			131			136	140
		SINGLES	875	1030	1180	1320	1450	1550	1650	1750	1850	1950	2060	2120	2240	2500
		DUALS	770	910	1040	1160	1280	1360	1450	1540	1630	1720	1810	1870	1970	2200
		TRIPLES	720	840	970	1080	1190	1270	1350	1440	1520	1600	1690	1740	1840	2050
14.9R46		LI							131			137			142	145
		SINGLES	1030	1215	1400	1550	1700	1800	1950	2060	2180	2300	2430	2500	2650	2900
		DUALS	910	1070	1230	1360	1500	1580	1720	1810	1920	2020	2140	2200	2330	2550
		TRIPLES	840	1000	1150	1270	1390	1480	1600	1690	1790	1890	1990	2050	2170	2380
15.5R38		LI							125							
		SINGLES	875	1030	1180	1320	1450	1550	1650							
		DUALS	770	910	1040	1160	1280	1360	1450							
		TRIPLES	720	840	970	1080	1190	1270	1350							
16.9R24		LI							126			134				
		SINGLES	900	1060	1215	1360	1500	1600	1700	1850	1950	2120				
		DUALS	790	930	1070	1200	1320	1410	1500	1630	1720	1870				
		TRIPLES	740	870	1000	1120	1230	1310	1390	1520	1600	1740				
16.9R26		LI							128			135				
		SINGLES	925	1120	1250	1400	1550	1650	1800	1900	2000	2180				
		DUALS	810	990	1100	1230	1360	1450	1580	1670	1760	1920				
		TRIPLES	760	920	1030	1150	1270	1350	1480	1560	1640	1790				
16.9R28		LI							129			136				
		SINGLES	975	1150	1320	1450	1600	1700	1850	1950	2060	2240				
		DUALS	860	1010	1160	1280	1410	1500	1630	1720	1810	1970				
		TRIPLES	800	940	1080	1190	1310	1390	1520	1600	1690	1840				
16.9R30		LI							130			137			141	144
		SINGLES	1000	1180	1360	1550	1650	1750	1900	2000	2120	2300	2360	2430	2575	2800
		DUALS	880	1040	1200	1360	1450	1540	1670	1760	1870	2020	2080	2140	2270	2460
		TRIPLES	820	970	1120	1270	1350	1440	1560	1640	1740	1890	1940	1990	2110	2300
16.9R38		LI							134			141				
		SINGLES	1120	1320	1500	1700	1850	2000	2120	2240	2430	2575				
		DUALS	990	1160	1320	1500	1630	1760	1870	1970	2140	2270				
		TRIPLES	920	1080	1230	1390	1520	1640	1740	1840	1990	2110				
18.4R26		LI							134			140				
		SINGLES	1120	1320	1500	1700	1850	2000	2120	2240	2430	2575				
		DUALS	990	1160	1320	1500	1630	1760	1870	1970	2140	2270				
		TRIPLES	920	1080	1230	1390	1520	1640	1740	1840	1990	2110				
18.4R28		LI							135			141			146	
		SINGLES	1150	1360	1550	1900	2060	2240	2430	2575	2725	2900	3000	3150	3250	
		DUALS	1010	1200	1360	1670	1810	1970	2140	2270	2400	2460	2640	2770	2860	
		TRIPLES	940	1120	1270	1560	1690	1840	1990	2110	2230	2300	2460	2580	2670	

RADIAL FARM
BIAS FARM
FRONTS & IMPLEMENTS
FORESTRY & FLOTATION
DISCONTINUED
LOAD & INFLATION TABLES
GENERAL TIRE INFORMATION
WARRANTY

FOR RIM AND WHEEL LOAD INFORMATION, SEE IMPORTANT NOTES ON PAGES 168-172.

TABLE A – RADIAL PLY AGRICULTURAL TRACTOR DRIVE WHEEL TIRES

BASIC TIRE LOAD RATINGS FOR TIRE SELECTION

ENGLISH UNITS OF MEASURE (lbs@psi)

TIRE SIZE	INFLATION		LOAD LIMITS AT VARIOUS COLD INFLATION PRESSURES													
	psi		6	8	10	12	14	16	18	20	22	24	26	28	30	36
	Symbol								*			**			***	****
LOAD LIMITS IN LBS., INFLATION PRESSURE IN PSI																
18.4R30		LI							137			143			147	
	SINGLES		2600	3080	3520	3960	4300	4680	5080	5360	5680	6000	6150	6400	6800	
	DUALS		2290	2710	3100	3490	3780	4120	4470	4720	5000	5280	5410	5630	5980	
	TRIPLES		2130	2530	2890	3250	3530	3840	4170	4400	4660	4920	5040	5250	5580	
18.4R34		LI							139			144			149	
	SINGLES		2830	3300	3740	4180	4540	4940	5360	5680	6000	6150	6600	6950	7150	
	DUALS		2490	2900	3290	3680	4000	4250	4720	5000	5280	5410	5810	6120	6290	
	TRIPLES		2320	2710	3070	3430	3720	4050	4400	4660	4920	5040	5410	5700	5860	
18.4R38		LI							141			144			151	155
	SINGLES		3000	3520	3960	4400	4800	5200	5680	6000	6400	6600	6950	7400	7600	8550
	DUALS		2640	3100	3480	3870	4220	4580	5000	5280	5630	5810	6120	6510	6690	7520
	TRIPLES		2460	2890	3250	3610	3940	4260	4660	4920	5250	5410	5700	6070	6230	7010
18.4R42		LI							143			148			153	
	SINGLES		3080	3740	4180	4680	5080	5520	6000	6400	6600	6950	7400	7600	8050	
	DUALS		2710	3290	3680	4120	4470	4860	5280	5630	5810	6120	6510	6690	7080	
	TRIPLES		2530	3070	3430	3840	4170	4530	4920	5250	5410	5700	6070	6230	6600	
18.4R46		LI							144			150			155	
	SINGLES		3300	3860	4400	4940	5360	5840	6150	6600	6950	7400	7850	8050	8550	
	DUALS		2900	3400	3870	4350	4720	5140	5410	5810	6120	6510	6910	7080	7520	
	TRIPLES		2710	3170	3610	4050	4400	4790	5040	5410	5700	6070	6440	6600	7010	
20.8R34		LI							145							
	SINGLES		3420	3960	4540	5080	5520	6000	6400							
	DUALS		3010	3480	4000	4470	4860	5280	5630							
	TRIPLES		2800	3250	3720	4170	4530	4920	5250							
20.8R38		LI							147			153				
	SINGLES		3640	4300	4800	5360	5840	6400	6800	7150	7600	8050				
	DUALS		3200	3780	4220	4720	5140	5630	5980	6290	6690	7080				
	TRIPLES		2980	3530	3940	4400	4790	5250	5580	5860	6230	6600				
20.8R42		LI							149			155				
	SINGLES		3740	4540	5080	5680	6150	6800	7150	7600	8050	8550				
	DUALS		3290	4000	4470	5000	5410	5980	6290	6690	7080	7520				
	TRIPLES		3070	3720	4170	4660	5040	5580	5840	6230	6600	7010				
***23.1R42		LI							147			153			157	
	SINGLES		3520	4180	4800	5360	5840	6400	6800	7150	7600	8050	8250	8800	9100	
	DUALS		3100	3680	4220	4720	5140	5630	5980	6290	6690	7080	7260	7740	8010	
	TRIPLES		2890	3430	3940	4400	4790	5250	5580	5860	6230	6600	6770	7220	7460	
23.1R34		LI							151							
	SINGLES		3960	4680	5360	6000	6600	7150	7600							
	DUALS		3480	4120	4720	5280	5810	6290	6690							
	TRIPLES		3250	3840	4400	4920	5410	5860	6230							

*** 23.1R26: 11700 lbs @ 46 psi / (LI 166)

FOR RIM AND WHEEL LOAD INFORMATION, SEE IMPORTANT NOTES ON PAGES 168-172.

RADIAL FARM

BIAS FARM

FRONTS & IMPLEMENTS

FORESTRY & FLOTATION

DISCONTINUED

LOAD & INFLATION TABLES

GENERAL TIRE INFORMATION

WARRANTY

TABLE A – RADIAL PLY AGRICULTURAL TRACTOR DRIVE WHEEL TIRES

BASIC TIRE LOAD RATINGS FOR TIRE SELECTION METRIC UNITS OF MEASURE (kg@kPa)

TIRE SIZE	INFLATION		LOAD LIMITS AT VARIOUS COLD INFLATION PRESSURES													
	kPa		40	60	70	80	100	110	120	140	150	160	180	190	210	250
	Symbol								*			**			***	****
LOAD LIMITS IN KG., INFLATION PRESSURE IN kPa																
18.4R30		LI							137			143			147	
	SINGLES		1180	1400	1600	1800	1950	2120	2300	2430	2575	2725	2800	2900	3075	
	DUALS		1040	1230	1410	1580	1720	1870	2020	2140	2270	2400	2460	2550	2710	
	TRIPLES		970	1150	1310	1480	1600	1740	1890	1990	2110	2230	2300	2380	2520	
18.4R34		LI							139			144			149	
	SINGLES		1285	1500	1700	1900	2060	2240	2430	2575	2725	2800	3000	3150	3250	
	DUALS		1130	1320	1500	1670	1810	1970	2140	2270	2400	2460	2640	2770	2860	
	TRIPLES		1050	1230	1390	1560	1690	1840	1990	2110	2240	2300	2460	2580	2670	
18.4R38		LI							141			144			151	155
	SINGLES		1360	1600	1800	2000	2180	230	2575	2725	2900	3000	3150	3350	3450	3875
	DUALS		1200	1410	1580	1760	1920	2080	2270	2400	2550	2640	2770	2950	3040	3410
	TRIPLES		1120	1310	1480	1640	1790	1940	2110	2230	2380	2460	2580	2750	2830	3180
18.4R42		LI							143			148			153	
	SINGLES		1400	1700	1900	2120	2300	2500	2725	2900	3000	3150	3350	3450	3650	
	DUALS		1230	1500	1670	1870	2020	2200	2400	2550	2640	2770	2950	3040	320	
	TRIPLES		1150	1390	1560	1740	1890	2050	2230	2380	2460	2580	2750	2830	2990	
18.4R46		LI							144			150			155	
	SINGLES		1500	1750	2000	2240	2430	2650	2800	3000	3150	3350	3550	3650	3875	
	DUALS		1320	1540	1760	1970	2140	2330	2460	2640	2770	2950	3120	3210	3410	
	TRIPLES		1230	1440	1640	1840	1990	2170	2300	2460	2580	2750	2910	2990	3180	
20.8R34		LI							145							
	SINGLES		1550	1800	2060	2300	2500	2725	2900							
	DUALS		1360	1580	1810	2020	2200	2400	2550							
	TRIPLES		1270	1480	1690	1890	2050	2230	2380							
20.8R38		LI							147			153				
	SINGLES		1650	1950	2180	2430	2650	2900	3075	3250	3450	3650				
	DUALS		1450	1720	1920	2140	2330	2550	2710	2860	3040	3210				
	TRIPLES		1350	1600	1790	1990	2170	2380	2520	2670	2830	2990				
20.8R42		LI							149			155				
	SINGLES		1700	2060	2300	2575	2800	3075	3250	3450	3650	3875				
	DUALS		1500	1810	2020	2270	2460	2710	2860	3040	3210	3410				
	TRIPLES		1390	1690	1890	2110	2300	2520	2670	2830	2990	3180				
***23.1R42		LI							147			153			157	
	SINGLES		1600	1900	2180	2430	2650	2900	3075	3250	3450	3650	3750	4000	4125	
	DUALS		1410	1670	1920	2140	2330	2550	2710	2860	3040	3210	3300	3520	3630	
	TRIPLES		1310	1560	1790	1990	2170	2380	2520	2670	2830	2990	3080	3280	3380	
23.1R34		LI							151							
	SINGLES		1830	2120	2430	2725	2800	3075	3250							
	DUALS		1580	1870	2140	2400	2460	2710	2860							
	TRIPLES		1480	1740	1990	2230	2300	2520	2670							

*** 23.1R26: 5300 kg @ 320 kPa / (LI 166)

FOR RIM AND WHEEL LOAD INFORMATION, SEE IMPORTANT NOTES ON PAGES 168-172.

RADIAL FARM
BIAS FARM
FRONTS & IMPLEMENTS
FORESTRY & FLOTATION
DISCONTINUED
LOAD & INFLATION TABLES
GENERAL TIRE INFORMATION
WARRANTY

TABLE A – RADIAL PLY AGRICULTURAL TRACTOR DRIVE WHEEL TIRES

BASIC TIRE LOAD RATINGS FOR TIRE SELECTION

ENGLISH UNITS OF MEASURE (lbs@psi)

TIRE SIZE	INFLATION		LOAD LIMITS AT VARIOUS COLD INFLATION PRESSURES														
	psi	Symbol	6	8	10	12	14	16	18	20	22	24	26	28	30	36	
									*			**			***	****	
LOAD LIMITS IN LBS., INFLATION PRESSURE IN PSI																	
24.5R32		LI															
	SINGLES		4300	5080	5840	6400	7150	7600	8250								
	DUALS		3780	4470	5140	5630	6290	6690	7260								
	TRIPLES		3530	4170	4790	5250	5860	6230	6770								
30.5LR32		LI															
	SINGLES		5080	6150	6950	7600	8550	9100	9650	10500	11000	11700	12000	12800	13200		
	DUALS		4470	5410	6120	6690	7520	8010	8690	9240	9680	10300	10560	11260	11620		
	TRIPLES		4170	5040	5700	6230	7010	7460	7910	8610	9020	9590	9840	10500	10820		

NOTES:

- Boldface denotes maximum load for the Symbol shown and the Service Description (Load Index Speed Symbol).
- For shipping purposes, tire inflation pressures may be increased to 30 psi (210 kPa) (consult tire manufacture for minimum shipping pressure). This higher inflation pressure must be reduced to operating inflation before the machine is removed from the carrier.
- For transport service above 20 mph (30 km/h), recommended minimum inflation pressure is 8 psi (60 kPa).
- When running lower inflation pressures, it is extremely important to use an accurate air pressure gauge.
- For hillside operations and for moldboard plowing with single drive tires in the furrow, add 4 psi (30 kPa).
- For R-2 tires, above loads apply, however maximum speed is **25 mph (40 km/h)**.
- For above tires (except R-2) used in cyclic loading field service see Load Table F1 on pages 195-196.
- For above R-2 tires used in cyclic loading service (except hillside combines) without sustained high torque with speeds up to 5 mph (10 km/h) above loads may be increased 70% [with 6 psi (40 kPa) increase in inflation pressure]. This load increase is also applicable to tires used on vehicles with mechanisms capable of maintaining tires and wheels in vertical position on slopes to 11° (20% grade).
- For transport service and operations which do not require sustained high torque, the load limits shown at right at various speeds apply with no change in inflation pressure [R-2 maximum speed is 25 mph (40 km/h)].

MAX SPEED	% CHANGE IN TABLE
10 mph (15 km/h)	+34% (except hillside combines)
15 mph (25 km/h)	+11% (except hillside combines)
20 mph (30 km/h)	7%
25 mph (40 km/h)	None
30 mph (50 km/h)	None

FOR RIM AND WHEEL LOAD INFORMATION, SEE IMPORTANT NOTES ON PAGES 168-172.

TABLE A – RADIAL PLY AGRICULTURAL TRACTOR DRIVE WHEEL TIRES

BASIC TIRE LOAD RATINGS FOR TIRE SELECTION

METRIC UNITS OF MEASURE (kg@kPa)

TIRE SIZE	INFLATION		LOAD LIMITS AT VARIOUS COLD INFLATION PRESSURES														
	kPa	Symbol	40	60	70	80	100	110	120	140	150	160	180	190	210	250	
									*			**			***	****	
LOAD LIMITS IN KG., INFLATION PRESSURE IN kPa																	
24.5R32		LI							154								
	SINGLES		1950	2301	2650	2900	3250	3450	3750								
	DUALS		1720	2030	2330	2550	2860	3040	3300								
	TRIPLES		1600	1890	2170	2380	2670	2830	3080								
30.5LR32		LI							159			166			170		
	SINGLES		2300	2800	3150	3450	3875	4125	4375	4750	5000	5300	5450	5800	6000		
	DUALS		2020	2460	2770	3040	3410	3630	3850	4180	4400	4660	4800	5100	5280		
	TRIPLES		1890	2300	2580	2830	3180	3380	3590	3900	4100	4350	4470	4760	4920		

NOTES:

- Boldface denotes maximum load for the Symbol shown and the Service Description (Load Index Speed Symbol).
- For shipping purposes, tire inflation pressures may be increased to 30 psi (210 kPa) (consult tire manufacture for minimum shipping pressure). This higher inflation pressure must be reduced to operating inflation before the machine is removed from the carrier.
- For transport service above 20 mph (30 km/h), recommended minimum inflation pressure is 8 psi (60 kPa).
- When running lower inflation pressures, it is extremely important to use an accurate air pressure gauge.
- For hillside operations and for moldboard plowing with single drive tires in the furrow, add 4 psi (30 kPa).
- For R-2 tires, above loads apply, however maximum speed is **25 mph (40 km/h)**.
- For above tires (except R-2) used in cyclic loading field service see Load Table F1 on pages 195-196.
- For above R-2 tires used in cyclic loading service (except hillside combines) without sustained high torque with speeds up to 5 mph (10 km/h) above loads may be increased 70% [with 6 psi (40 kPa) increase in inflation pressure]. This load increase is also applicable to tires used on vehicles with mechanisms capable of maintaining tires and wheels in vertical position on slopes to 11° (20% grade).
- For transport service and operations which do not require sustained high torque, the load limits shown at right at various speeds apply with no change in inflation pressure [R-2 maximum speed is 25 mph (40 km/h)].

MAX SPEED	% CHANGE IN TABLE
10 mph (15 km/h)	+34% (except hillside combines)
15 mph (25 km/h)	+11% (except hillside combines)
20 mph (30 km/h)	7%
25 mph (40 km/h)	None
30 mph (50 km/h)	None

FOR RIM AND WHEEL LOAD INFORMATION, SEE IMPORTANT NOTES ON PAGES 168-172.

TABLE B – METRIC RADIAL PLY AGRICULTURAL TRACTOR DRIVE WHEEL TIRES

TIRE TYPE NOMENCLATURE		MAX SPEED	
TRA	TIRE TYPE	A/B	D
R-1	Drive Wheel, Regular Tread	30 mph	40 mph
R-1W	Drive Wheel, Wet Traction Tread	30 mph	40 mph
R-2	Cane & Rice, Drive Wheel, Deep Tread	25 mph	—

BASIC TIRE LOAD RATINGS FOR TIRE SELECTION ENGLISH UNITS OF MEASURE (lbs@psi)

TIRE SIZE	INFLATION psi Symbol	LOAD LIMITS AT VARIOUS COLD INFLATION PRESSURES														
		6	9	12	15	17	20	23	26	29	35	41	46	52	58	64
LOAD LIMITS IN LBS., INFLATION PRESSURE IN PSI																
230/95R48	LI					114		121		123	126	129	132	134		
	SINGLES	1430	1710	2040	2270	2600	2910	3200	3300	3420	3740	4080	4400	4680		
	DUALS	1260	1500	1800	2000	2290	2560	2820	2900	3010	3290	3590	3870	4120		
	TRIPLES	1170	1400	1670	1860	2130	2390	2620	2710	2800	3070	3350	3610	3840		
280/70R16	LI					95		102		108	112					
	SINGLES	855	1020	1200	1360	1520	1710	1870	2040	2200	2470					
	DUALS	750	900	1060	1200	1340	1500	1650	1800	1940	2170					
	TRIPLES	700	840	980	1120	1250	1400	1530	1670	1800	2030					
280/70R18	LI					97		104		110	114					
	SINGLES	910	1070	1280	1430	1610	1820	1980	2150	2340	2600					
	DUALS	800	940	1130	1260	1420	1600	1740	1890	2060	2290					
	TRIPLES	750	880	1050	1170	1320	1490	1620	1760	1920	2130					
280/70R20	LI					99		106		112	116					
	SINGLES	935	1140	1320	1520	1710	1870	2090	2270	2470	2760					
	DUALS	820	1000	1160	1340	1500	1650	1840	2000	2170	2430					
	TRIPLES	770	930	1080	1250	1400	1530	1710	1860	2030	2260					
280/85R24	LI					108		115								
	SINGLES	1230	1480	1710	1930	2200	2470	2680								
	DUALS	1080	1300	1500	1700	1940	2170	2360								
	TRIPLES	1010	1210	1400	1580	1800	2030	2200								
290/95R34	LI					119		125		129	131					
	SINGLES	1650	2040	2340	2680	3000	3300	3640	3860	4080	4300					
	DUALS	1450	1800	2060	2360	2640	2900	3200	3400	3590	3780					
	TRIPLES	1350	1670	1920	2200	2460	2710	2980	3170	3350	3530					
300/70R20	LI					102		110		116	120					
	SINGLES	1050	1280	1480	1650	1870	2090	2340	2540	2760	3080					
	DUALS	920	1130	1300	1450	1650	1840	2060	2240	2430	2710					
	TRIPLES	860	1050	1210	1350	1530	1710	1920	2080	2260	2530					
320/85R24	LI					115		122								
	SINGLES	1480	1820	2090	2400	2680	3000	3300								
	DUALS	1300	1600	1840	2110	2360	2640	2900								
	TRIPLES	1210	1490	1710	1970	2200	2460	2710								
320/85R28	LI					118		124								
	SINGLES	1610	1930	2270	2600	2910	3200	3520								
	DUALS	1420	1700	2000	2290	2560	2820	3100								
	TRIPLES	1320	1580	1860	2130	2390	2620	2890								

FOR RIM AND WHEEL LOAD INFORMATION, SEE IMPORTANT NOTES ON PAGES 168-172.

RADIAL FARM
BIAS FARM
FRONTS & IMPLEMENTS
FORESTRY & FLOTATION
DISCONTINUED
LOAD & INFLATION TABLES
GENERAL TIRE INFORMATION
WARRANTY

TABLE B – METRIC RADIAL PLY AGRICULTURAL TRACTOR DRIVE WHEEL TIRES

TIRE TYPE NOMENCLATURE		MAX SPEED	
TRA	TIRE TYPE	A8/B	D
R-1	Drive Wheel, Regular Tread	50 km/h	65 km/h
R-1W	Drive Wheel, Wet Traction Tread	50 km/h	65 km/h
R-2	Cane & Rice, Drive Wheel, Deep Tread	40 km/h	—

BASIC TIRE LOAD RATINGS FOR TIRE SELECTION
METRIC UNITS OF MEASURE (kg@kPa)

TIRE SIZE	INFLATION	LOAD LIMITS AT VARIOUS COLD INFLATION PRESSURES															
		kPa	40	60	80	100	120	140	160	180	200	240	280	320	360	400	440
		bar	0.4	0.6	0.8	1.0	1.2	1.4	1.6	1.8	2.0	2.4	2.8	3.2	3.6	4.0	4.4
LOAD LIMITS IN KG., INFLATION PRESSURE IN kPa																	
230/95R48	LI							114		121		123	126	129	132	134	
	SINGLES		650	775	925	1030	1180	1320	1450	1500	1550	1700	1850	2000	2120		
	DUALS		570	680	810	910	1040	1160	1280	1320	1360	1500	1630	1760	1870		
	TRIPLES		530	640	760	840	970	1080	1190	1230	1270	1390	1520	1640	1740		
280/70R16	LI						95		102		108	112					
	SINGLES		387	462	545	615	690	775	850	925	1000	1120					
	DUALS		340	410	480	540	610	680	750	810	880	990					
	TRIPLES		320	380	450	500	570	640	700	760	820	920					
280/70R18	LI						97		104		110	114					
	SINGLES		412	487	580	650	730	825	900	975	1060	1180					
	DUALS		360	430	510	570	640	730	790	860	930	1040					
	TRIPLES		340	400	480	530	600	680	740	800	870	970					
280/70R20	LI						99		106		112	116					
	SINGLES		425	515	600	690	775	850	950	1030	1120	1250					
	DUALS		370	450	530	610	680	750	840	910	990	1100					
	TRIPLES		350	420	490	570	640	700	780	840	920	1030					
280/85R24	LI						108		115								
	SINGLES		560	670	775	875	1000	1120	1215								
	DUALS		490	590	680	770	880	990	1070								
	TRIPLES		460	550	640	720	820	920	1000								
290/95R34	LI						119		125		129	131					
	SINGLES		750	925	1060	1215	1360	1500	1650	1750	1850	1950					
	DUALS		660	810	930	1070	1200	1320	1450	1540	1630	1720					
	TRIPLES		620	760	870	1000	1120	1230	1350	1440	1520	1600					
300/70R20	LI						102		110		116	120					
	SINGLES		475	580	670	750	850	950	1060	1150	1250	1400					
	DUALS		420	510	590	660	750	840	930	1010	1100	1230					
	TRIPLES		390	480	550	620	700	780	870	940	1030	1150					
320/85R24	LI						115		122								
	SINGLES		670	825	950	1090	1215	1360	1500								
	DUALS		590	730	840	960	1070	1200	1320								
	TRIPLES		550	680	780	890	1000	1120	1230								
320/85R28	LI						118		124								
	SINGLES		730	875	1030	1180	1320	1450	1600								
	DUALS		640	770	910	1040	1160	1280	1410								
	TRIPLES		600	720	840	970	1080	1190	1310								

FOR RIM AND WHEEL LOAD INFORMATION, SEE IMPORTANT NOTES ON PAGES 168-172.



RADIAL FARM

BIAS FARM

FRONTS & IMPLEMENTS

FORESTRY & FLOTATION

DISCONTINUED

LOAD & INFLATION TABLES

GENERAL TIRE INFORMATION

WARRANTY

TABLE B – METRIC RADIAL PLY AGRICULTURAL TRACTOR DRIVE WHEEL TIRES

BASIC TIRE LOAD RATINGS FOR TIRE SELECTION

ENGLISH UNITS OF MEASURE (lbs@psi)

TIRE SIZE	INFLATION		LOAD LIMITS AT VARIOUS COLD INFLATION PRESSURES														
	psi	Symbol	6	9	12	15	17	20	23	26	29	35	41	46	52	58	64
	LOAD LIMITS IN LBS., INFLATION PRESSURE IN PSI																
320/85R34		LI					121		127		131	133					
	SINGLES		1760	2150	2470	2830	3200	3520	3860	4080	4300	4540					
	DUALS		1550	1890	2170	2490	2820	3100	3400	3590	3780	4000					
	TRIPLES		1440	1760	2030	2320	2620	2890	3170	3350	3530	3720					
320/85R38		LI					123		129		133	135	138	141	143		
	SINGLES		1870	2270	2600	3000	3420	3740	4080	4300	4540	4800	5200	5680	6000		
	DUALS		1650	2000	2290	2640	3010	3290	3590	3780	4000	4220	4580	5000	5280		
	TRIPLES		1530	1860	2130	2460	2800	3070	3350	3530	3720	3940	4260	4660	4920		
320/90R42		LI					126		133		136	139					
	SINGLES		2090	2470	2910	3300	3740	4180	4540	4800	4940	5360					
	DUALS		1840	2170	2560	2900	3290	3680	4000	4220	4350	4720					
	TRIPLES		1710	2030	2390	2710	3070	3430	3720	3940	4050	4400					
320/90R46		LI					127		135		138	140	144	146	148		
	SINGLES		2150	2600	3000	3420	3860	4300	4800	5080	5200	5520	6150	6600	6950		
	DUALS		1890	2290	2640	3010	3400	3780	4220	4470	4580	4860	5410	5810	6120		
	TRIPLES		1760	2130	2460	2800	3170	3530	3940	4170	4260	4530	5040	5410	5700		
320/90R50		LI					129		136		140	142	145	148			
	SINGLES		2270	2760	3200	3640	4080	4540	4940	5200	5520	5840	6400	6950			
	DUALS		2000	2430	2820	3200	3590	4000	4350	4580	4860	5140	5630	6120			
	TRIPLES		1860	2260	2620	2980	3350	3720	4050	4260	4530	4790	5250	5700			
320/90R54		LI					131		138		141	143	146	149			
	SINGLES		2340	2830	3300	3740	4300	4680	5200	5520	5680	6000	6600	7150			
	DUALS		2060	2490	2900	3290	3780	4120	4580	4860	5000	5280	5810	6290			
	TRIPLES		1920	2320	2710	3070	3530	3840	4260	4530	4660	4920	5410	5860			
340/85R24		LI					119		125								
	SINGLES		1650	1980	2270	2600	3000	3300	3640								
	DUALS		1450	1740	2000	2290	2640	2900	3200								
	TRIPLES		1350	1620	1860	2130	2460	2710	2980								
340/85R28		LI					121		127								
	SINGLES		1760	2090	2470	2830	3200	3520	3860								
	DUALS		1550	1840	2170	2490	2820	3100	3400								
	TRIPLES		1440	1710	2030	2320	2620	2890	3170								
360/70R20		LI					113		120		125	129					
	SINGLES		1390	1650	1930	2200	2540	2760	3080	3300	3640	4080					
	DUALS		1220	1450	1700	1940	2240	2430	2710	2900	3200	3590					
	TRIPLES		1140	1350	1580	1800	2080	2260	2530	2710	2980	3350					
360/70R28		LI					118		125								
	SINGLES		1610	1930	2270	2600	2910	3300	3640								
	DUALS		1420	1700	2000	2290	2560	2900	3200								
	TRIPLES		1320	1580	1860	2130	2390	2710	2990								
380/70R24		LI					119		125								
	SINGLES		1650	1980	2270	2600	3000	3300	3640								
	DUALS		1450	1740	2000	2290	2640	2900	3200								
	TRIPLES		1350	1620	1860	2130	2460	2710	2980								

FOR RIM AND WHEEL LOAD INFORMATION, SEE IMPORTANT NOTES ON PAGES 168-172.

RADIAL FARM
 BIAS FARM
 FRONTS & IMPLEMENTS
 FORESTRY & FLOTATION
 DISCONTINUED
 LOAD & INFLATION TABLES
 GENERAL TIRE INFORMATION
 WARRANTY

TABLE B – METRIC RADIAL PLY AGRICULTURAL TRACTOR DRIVE WHEEL TIRES

BASIC TIRE LOAD RATINGS FOR TIRE SELECTION

METRIC UNITS OF MEASURE (kg@kPa)

TIRE SIZE	INFLATION		LOAD LIMITS AT VARIOUS COLD INFLATION PRESSURES														
	kPa		40	60	80	100	120	140	160	180	200	240	280	320	360	400	440
	bar		0.4	0.6	0.8	1.0	1.2	1.4	1.6	1.8	2.0	2.4	2.8	3.2	3.6	4.0	4.4
LOAD LIMITS IN KG., INFLATION PRESSURE IN kPa																	
320/85R34		LI					121		127		131	133					
	SINGLES		800	975	1120	1285	1450	1600	1750	1850	1950	2060					
	DUALS		700	860	990	1130	1280	1410	1540	1630	1720	1810					
	TRIPLES		660	800	920	1050	1190	1310	1440	1520	1600	1690					
320/85R38		LI					123		129		133	135	138	141	143		
	SINGLES		850	1030	1180	1360	1550	1700	1850	1950	2060	2180	2360	2575	2725		
	DUALS		750	910	1040	1200	1360	1500	1630	1720	1810	1920	2080	2270	2400		
	TRIPLES		700	840	970	1120	1270	1390	1520	1600	1690	1790	1940	2110	2230		
320/90R42		LI					126		133		136	139					
	SINGLES		950	1120	1320	1500	1700	1900	2060	2180	2240	2430					
	DUALS		840	990	1160	1320	1500	1670	1810	1920	1970	2140					
	TRIPLES		780	920	1080	1230	1390	1560	1690	1790	1840	1990					
320/90R46		LI					127		135		138	140	144	146	148		
	SINGLES		975	1180	1360	1550	1750	1950	2180	2300	2360	2500	2800	3000	3150		
	DUALS		860	1040	1200	1360	1540	1720	1920	2020	2080	2200	2460	2640	2770		
	TRIPLES		800	970	1120	1270	1440	1600	1790	1890	1940	2050	2300	2460	2580		
320/90R50		LI					129		136		140	142	145	148			
	SINGLES		1030	1250	1450	1650	1850	2060	2240	2360	2500	2650	2900	3150			
	DUALS		910	1100	1280	1450	1630	1810	1970	2080	2200	2330	2550	2770			
	TRIPLES		840	1030	1190	1350	1520	1690	1840	1940	2050	2170	2380	2580			
320/90R54		LI					131		138		141	143	146	149			
	SINGLES		1060	1285	1500	1700	1950	2120	2360	2500	2575	2725	3000	3250			
	DUALS		930	1130	1320	1500	1720	1870	2080	2200	2270	2400	2640	2860			
	TRIPLES		870	1050	1230	1390	1600	1740	1940	2050	2110	2230	2460	2670			
340/85R24		LI					119		125								
	SINGLES		750	900	1030	1180	1360	1500	1650								
	DUALS		660	790	910	1040	1200	1320	1450								
	TRIPLES		620	740	840	970	1120	1230	1350								
340/85R28		LI					121		127								
	SINGLES		800	950	1120	1285	1450	1600	1750								
	DUALS		700	840	990	1130	1280	1410	1540								
	TRIPLES		660	780	920	1050	1190	1310	1440								
360/70R20		LI					113		120		125	129					
	SINGLES		630	750	875	1000	1150	1250	1400	1500	1650	1850					
	DUALS		550	660	770	880	1010	1100	1230	1320	1450	1630					
	TRIPLES		520	620	720	820	940	1030	1150	1230	1350	1520					
360/70R28		LI					118		125								
	SINGLES		730	875	1030	1180	1320	1500	1650								
	DUALS		640	770	910	1040	1160	1320	1450								
	TRIPLES		600	720	850	970	1080	1230	1350								
380/70R24		LI					119		125								
	SINGLES		750	900	1030	1180	1360	1500	1650								
	DUALS		660	790	910	1040	1200	1320	1450								
	TRIPLES		620	740	840	970	1120	1230	1350								

FOR RIM AND WHEEL LOAD INFORMATION, SEE IMPORTANT NOTES ON PAGES 168-172.

RADIAL FARM

BIAS FARM

FRONTS & IMPLEMENTS

FORESTRY & FLOTATION

DISCONTINUED

LOAD & INFLATION TABLES

GENERAL TIRE INFORMATION

WARRANTY

TABLE B – METRIC RADIAL PLY AGRICULTURAL TRACTOR DRIVE WHEEL TIRES

BASIC TIRE LOAD RATINGS FOR TIRE SELECTION

ENGLISH UNITS OF MEASURE (lbs@psi)

TIRE SIZE	INFLATION		LOAD LIMITS AT VARIOUS COLD INFLATION PRESSURES														
	psi	Symbol	6	9	12	15	17	20	23	26	29	35	41	46	52	58	64
	LOAD LIMITS IN LBS., INFLATION PRESSURE IN PSI																
380/70R28		LI					121		127								
	SINGLES		1760	2090	2470	2830	3200	3520	3860								
	DUALS		1550	1840	2170	2490	2820	3100	3400								
	TRIPLES		1440	1710	2030	2320	2620	2890	3170								
380/80R38		LI					130		137		140	142					
	SINGLES		2270	2760	3200	3640	4180	4540	5080	5360	5520	5840					
	DUALS		2000	2430	2820	3200	3680	4000	4470	4720	4860	5140					
	TRIPLES		1860	2260	2620	2980	3430	3720	4170	4400	4530	4790					
380/85R24		LI					124		131								
	SINGLES		1930	2340	2760	3080	3520	3860	4300								
	DUALS		1700	2060	2430	2710	3100	3400	3780								
	TRIPLES		1580	1920	2260	2530	2890	3170	3530								
380/85R26		LI					125		132								
	SINGLES		2040	2400	2830	3200	3640	4080	4400								
	DUALS		1800	2110	1780	2820	3200	3590	3870								
	TRIPLES		1670	1970	2320	2620	2980	3350	3610								
380/85R28		LI					126		133								
	SINGLES		2090	2540	2910	3300	3740	4180	4540								
	DUALS		1840	2240	2560	2900	3290	3680	4000								
	TRIPLES		1710	2080	2390	2710	3070	3430	3720								
380/85R30		LI					127		135								
	SINGLES		2150	2600	3000	3420	3860	4300	4800								
	DUALS		1890	2290	2640	3010	3400	3780	4220								
	TRIPLES		1760	2130	2460	2800	3170	3530	3940								
380/85R34		LI					129		137		140	142	145				
	SINGLES		2270	2760	3200	3640	4080	4540	5080	5360	5520	5840	6400				
	DUALS		2000	2430	2820	3200	3590	4000	4470	4720	5860	5140	5630				
	TRIPLES		1860	2260	2620	2980	3350	3720	4170	4400	4530	4790	5250				
385/85R34		LI					130		138		141	143	146				
	SINGLES		2340	2830	3300	3740	4180	4680	5200	5360	5680	6000	6600				
	DUALS		2060	2490	2900	3290	3680	4120	4580	4720	5000	5280	5810				
	TRIPLES		1920	2320	2710	3070	3430	3840	4260	4400	4660	4920	5410				
380/90R46		LI					137		144		147	149	152				
	SINGLES		2830	3300	3860	4400	5080	5520	6150	6400	6800	7150	7850				
	DUALS		2490	2900	3400	3870	4470	4860	5410	5630	5980	6290	6910				
	TRIPLES		2320	2710	3170	3610	4170	4530	5040	5250	5580	5860	6440				
380/90R50		LI					138		145		148	151					
	SINGLES		2910	3520	4080	4680	5200	5840	6400	6800	6950	7600					
	DUALS		2560	3100	3590	4120	4580	5140	5630	5980	6120	6690					
	TRIPLES		2390	2890	3350	3840	4260	4790	5250	5580	5700	6230					
380/90R54		LI					140		146		150	152					
	SINGLES		3000	3640	4300	4800	5520	6000	6600	6950	7400	7850					
	DUALS		2640	3200	3780	4220	4860	5280	5810	6120	6510	6910					
	TRIPLES		2460	2980	3530	3940	4530	4920	5410	5700	6070	6440					

FOR RIM AND WHEEL LOAD INFORMATION, SEE IMPORTANT NOTES ON PAGES 168-172.

RADIAL FARM
BIAS FARM
FRONTS & IMPLEMENTS
FORESTRY & FLOTATION
DISCONTINUED
LOAD & INFLATION TABLES
GENERAL TIRE INFORMATION
WARRANTY

TABLE B – METRIC RADIAL PLY AGRICULTURAL TRACTOR DRIVE WHEEL TIRES

BASIC TIRE LOAD RATINGS FOR TIRE SELECTION

METRIC UNITS OF MEASURE (kg@kPa)

TIRE SIZE	INFLATION		LOAD LIMITS AT VARIOUS COLD INFLATION PRESSURES														
	kPa		40	60	80	100	120	140	160	180	200	240	280	320	360	400	440
	bar		0.4	0.6	0.8	1.0	1.2	1.4	1.6	1.8	2.0	2.4	2.8	3.2	3.6	4.0	4.4
LOAD LIMITS IN KG., INFLATION PRESSURE IN kPa																	
380/70R28		LI					121	127									
	SINGLES		800	950	1120	1285	1450	1600	1750								
	DUALS		700	840	990	1130	1280	1410	1540								
	TRIPLES		660	780	920	1050	1190	1310	1440								
380/80R38		LI					130	137		140	142						
	SINGLES		1030	1250	1450	1650	1900	2060	2300	2430	2500	2650					
	DUALS		910	1100	1280	1450	1670	1810	2020	2140	2200	2330					
	TRIPLES		840	1030	1190	1350	1560	1690	1890	1990	2050	2170					
380/85R24		LI					124	131									
	SINGLES		875	1060	1250	1400	1600	1750	1950								
	DUALS		770	930	1100	1230	1410	1540	1720								
	TRIPLES		720	870	1030	1150	1310	1440	1600								
380/85R26		LI					125	132									
	SINGLES		925	1090	1285	1450	1650	1850	2000								
	DUALS		810	960	1130	1280	1450	1630	1760								
	TRIPLES		760	890	1050	1190	1350	1520	1640								
380/85R28		LI					126	133									
	SINGLES		950	1150	1320	1500	1700	1900	2060								
	DUALS		840	1010	1160	1320	1500	1670	1810								
	TRIPLES		780	940	1080	1230	1390	1560	1690								
380/85R30		LI					127	135									
	SINGLES		975	1180	1360	1550	1750	1950	2180								
	DUALS		860	1040	1200	1360	1540	1720	1920								
	TRIPLES		800	970	1120	1270	1440	1600	1790								
380/85R34		LI					129	137		140	142	145					
	SINGLES		1030	1250	1450	1650	1850	2060	2300	2430	2500	2650	2900				
	DUALS		910	1100	1280	1450	1630	1810	2020	2140	2200	2330	2550				
	TRIPLES		840	1030	1190	1350	1520	1690	1890	1990	2050	2170	2380				
385/85R34		LI					130	138		141	143	146					
	SINGLES		1060	1285	1500	1700	1900	2120	2360	2430	2575	2725	3000				
	DUALS		930	1130	1320	1500	1670	1870	2080	2140	2270	2400	2640				
	TRIPLES		870	1050	1230	1390	1560	1740	1940	1990	2110	2230	2460				
380/90R46		LI					137	144		147	149	152					
	SINGLES		1285	1500	1750	2000	2300	2500	2800	2900	3075	3250	3550				
	DUALS		1130	1320	1540	1760	2020	2200	2460	2550	2710	2860	3120				
	TRIPLES		1050	1230	1440	1640	1890	2050	2300	2380	2520	2670	2910				
380/90R50		LI					138	145		148	151						
	SINGLES		1320	1600	1850	2120	2360	2650	2900	3075	3150	3450					
	DUALS		1160	1410	1630	1870	2080	2330	2550	2710	2770	3040					
	TRIPLES		1080	1310	1520	1740	1940	2170	2380	2520	2580	2830					
380/90R54		LI					140	146		150	152						
	SINGLES		1360	1650	1950	2180	2500	2725	3000	3150	3350	3550					
	DUALS		1200	1450	1720	1920	2200	2400	2640	2770	2950	3120					
	TRIPLES		1120	1350	1600	1790	2050	2230	2460	2580	2750	2910					

FOR RIM AND WHEEL LOAD INFORMATION, SEE IMPORTANT NOTES ON PAGES 168-172.

TABLE B – METRIC RADIAL PLY AGRICULTURAL TRACTOR DRIVE WHEEL TIRES

BASIC TIRE LOAD RATINGS FOR TIRE SELECTION

ENGLISH UNITS OF MEASURE (lbs@psi)

TIRE SIZE	INFLATION psi Symbol	LOAD LIMITS AT VARIOUS COLD INFLATION PRESSURES														
		6	9	12	15	17	20	23	26	29	35	41	46	52	58	64
		LOAD LIMITS IN LBS., INFLATION PRESSURE IN PSI														
380/105R50	LI					143		150		153	155	158	161	163	165	168
	SINGLES	3300	3960	4680	5360	6000	6600	7400	7600	8050	8550	9350	10200	10700	11400	12300
	DUALS	2900	3480	4120	4720	5280	5810	6510	6690	7080	7520	8230	8980	9420	10030	10825
	TRIPLES	2710	3250	3840	4400	4920	5410	6070	6230	6600	7010	7670	8360	8770	9350	10085
380/85R34	LI					129		137		140	142	145				
	SINGLES	2270	2760	3200	3640	4080	4540	5080	5360	5520	5840	6400				
	DUALS	2000	2430	1820	3200	3590	4000	4470	4720	4860	5140	5630				
	TRIPLES	1860	2260	2620	2980	3350	3720	4170	4400	4530	4790	5250				
400/75R38	LI					130		138								
	SINGLES	2340	2830	3300	3740	4180	4680	5200								
	DUALS	2060	2490	2900	3290	3670	4120	4580								
	TRIPLES	1920	2320	2700	3070	3430	3840	4260								
420/70R24	LI					123		130								
	SINGLES	1930	2270	2680	3080	3420	3860	4180								
	DUALS	1700	2000	2360	2710	3010	3400	3680								
	TRIPLES	1580	1860	2200	2530	2800	3170	3430								
420/80R46	LI					139		145		149	151	154	156	159	161	
	SINGLES	2910	3520	4080	4680	5360	5840	6400	6800	7150	7600	8250	8800	9650	10200	
	DUALS	2560	3100	3590	4120	4720	5140	5630	5980	6290	6690	7260	7740	8490	8980	
	TRIPLES	2390	2890	3350	3840	4400	4790	5250	5580	5860	6230	6770	7220	7910	8360	
420/85R24	LI					129		137								
	SINGLES	2270	2760	3200	3640	4080	4540	5080								
	DUALS	2000	2430	2820	3200	3590	4000	4470								
	TRIPLES	1860	2260	2620	2980	3350	3720	4170								
420/85R26	LI					131		138								
	SINGLES	2340	2830	3300	3740	4300	4680	5200								
	DUALS	2060	2490	2900	3290	3780	4120	4580								
	TRIPLES	1920	2320	2710	3070	3530	3840	4260								
420/85R28	LI					132		139								
	SINGLES	2470	2910	3420	3860	4400	4940	5360								
	DUALS	2170	2560	3010	3400	3870	4350	4720								
	TRIPLES	2030	2390	2800	3170	3610	4050	4400								
420/85R30	LI					133		140								
	SINGLES	2540	3000	3520	4080	4540	5080	5520								
	DUALS	2240	2640	3100	3590	4000	4470	4860								
	TRIPLES	2080	2460	2890	3350	3720	4170	4530								
420/85R34	LI					135		142		145	147					
	SINGLES	2680	3200	3740	4300	4800	5360	5840	6150	6400	6800					
	DUALS	2360	2820	3290	3780	4220	4720	5140	5410	5630	5980					
	TRIPLES	2200	2620	3070	3530	3940	4400	4790	5040	5250	5580					
420/85R38	LI					137		144								
	SINGLES	2830	3420	3960	4540	5080	5680	6150								
	DUALS	2490	3010	3480	4000	4470	5000	5410								
	TRIPLES	2320	2800	3250	3720	4170	4660	5040								

FOR RIM AND WHEEL LOAD INFORMATION, SEE IMPORTANT NOTES ON PAGES 168-172.

RADIAL FARM
 BIAS FARM
 FRONTS & IMPLEMENTS
 FORESTRY & FLOTATION
 DISCONTINUED
 LOAD & INFLATION TABLES
 GENERAL TIRE INFORMATION
 WARRANTY

TABLE B – METRIC RADIAL PLY AGRICULTURAL TRACTOR DRIVE WHEEL TIRES

BASIC TIRE LOAD RATINGS FOR TIRE SELECTION

METRIC UNITS OF MEASURE (kg@kPa)

TIRE SIZE	INFLATION		LOAD LIMITS AT VARIOUS COLD INFLATION PRESSURES														
	kPa		40	60	80	100	120	140	160	180	200	240	280	320	360	400	440
	bar		0.4	0.6	0.8	1.0	1.2	1.4	1.6	1.8	2.0	2.4	2.8	3.2	3.6	4.0	4.4
LOAD LIMITS IN KG., INFLATION PRESSURE IN kPa																	
380/105R50		LI					143		150		153	155	158	161	163	165	168
	SINGLES		1500	1800	2120	2430	2725	3000	3350	3450	3650	3875	4250	4625	4875	5150	5600
	DUALS		1320	1580	1870	2140	2400	2640	2950	3040	3210	3410	3740	4070	4290	4530	4930
	TRIPLES		1230	1480	1740	1990	2230	2460	2750	2830	2990	3180	3490	3790	4000	4220	4590
380/85R34		LI					129		137		140	142	145				
	SINGLES		1030	1250	1450	1650	1850	2060	2300	2430	2500	2650	2900				
	DUALS		910	1100	1280	1450	1630	1810	2020	2140	2200	2330	2550				
	TRIPLES		850	1030	1190	1350	1520	1690	1890	1990	2050	2170	2380				
400/75R38		LI					130		138								
	SINGLES		1060	1285	1500	1700	1900	2120	2360								
	DUALS		930	1130	1320	1500	1670	1870	2080								
	TRIPLES		870	1050	1230	1390	1620	1740	1940								
420/70R24		LI					123		130								
	SINGLES		875	1030	1215	1400	1550	1750	1900								
	DUALS		770	910	1070	1230	1360	1540	1670								
	TRIPLES		720	840	1000	1150	1270	1440	1560								
420/80R46		LI					139		145		149	151	154	156	159	161	
	SINGLES		1320	1600	1850	2120	2430	2650	2900	3075	3250	3450	3750	4000	4375	4625	
	DUALS		1160	1410	1630	1870	2140	2330	2550	2710	2860	3040	3300	3520	3850	4070	
	TRIPLES		1080	1310	1520	1740	1990	2170	2380	2520	2670	2830	3080	3280	3590	3790	
420/85R24		LI					129		137								
	SINGLES		1030	1250	1450	1650	1850	2060	2300								
	DUALS		910	1100	1280	1450	1630	1810	2020								
	TRIPLES		840	1030	1190	1350	1520	1690	1890								
420/85R26		LI					131		138								
	SINGLES		1060	1285	1500	1700	1950	2120	2360								
	DUALS		930	1130	1320	1500	1720	1870	2080								
	TRIPLES		870	1050	1230	1390	1600	1740	1940								
420/85R28		LI					132		139								
	SINGLES		1120	1320	1550	1750	2000	2240	2430								
	DUALS		990	1160	1360	1540	1760	1970	2140								
	TRIPLES		920	1080	1270	1440	1640	1840	1990								
420/85R30		LI					133		140								
	SINGLES		1150	1360	1600	1850	2060	2300	2500								
	DUALS		1010	1200	1410	1630	1810	2020	2200								
	TRIPLES		940	1120	1310	1520	1690	1890	2050								
420/85R34		LI					135		142		145	147					
	SINGLES		1215	1450	1700	1950	2180	2430	2650	2800	2900	3075					
	DUALS		1070	1280	1500	1720	1920	2140	2330	2460	2550	2710					
	TRIPLES		1000	1190	1390	1600	1790	1990	2170	2300	2380	2520					
420/85R38		LI					137		144								
	SINGLES		1285	1550	1800	2060	2300	2575	2800								
	DUALS		1130	1360	1580	1810	2020	2270	2460								
	TRIPLES		1050	1270	1480	1690	1890	2110	2300								

FOR RIM AND WHEEL LOAD INFORMATION, SEE IMPORTANT NOTES ON PAGES 168-172.

TABLE B – METRIC RADIAL PLY AGRICULTURAL TRACTOR DRIVE WHEEL TIRES

BASIC TIRE LOAD RATINGS FOR TIRE SELECTION

ENGLISH UNITS OF MEASURE (lbs@psi)

TIRE SIZE	INFLATION		LOAD LIMITS AT VARIOUS COLD INFLATION PRESSURES														
	psi	Symbol	6	9	12	15	17	20	23	26	29	35	41	46	52	58	64
	LOAD LIMITS IN LBS., INFLATION PRESSURE IN PSI																
420/90R30		LI					135		142		145						
	SINGLES		2680	3200	3740	4180	4800	5360	5840	6150	6400						
	DUALS		2360	2820	3290	3680	4220	4720	5140	5410	5630						
	TRIPLES		2200	2620	3070	3430	3940	4400	4790	5040	5250						
440/65R24		LI					123										
	SINGLES		1870	2270	2600	3000	3420	3740	3960								
	DUALS		1650	2000	2290	2640	3010	3290	3480								
	TRIPLES		1530	1860	2130	2460	2800	3070	3250								
440/65R28		LI					125		131								
	SINGLES		2040	2400	2830	3200	3640	3960	4300								
	DUALS		1800	2110	2490	2820	3200	3490	3780								
	TRIPLES		1670	1970	2320	2620	2990	3250	3530								
460/85R30		LI					138		145								
	SINGLES		2910	3520	4080	4680	5200	5840	6400								
	DUALS		2560	3100	3590	4120	4580	5140	5630								
	TRIPLES		2390	2890	3350	3840	4260	4790	5250								
460/85R34		LI					140	144	147								
	SINGLES		3080	3640	4300	4940	5520	6150	6800								
	DUALS		2710	3200	3780	4350	4860	5410	5980								
	TRIPLES		2530	2980	3530	4050	4530	5040	5580								
460/85R38		LI					142		149								
	SINGLES		3200	3860	4540	5200	5840	6400	7150								
	DUALS		2820	3400	4000	4580	5140	5630	6290								
	TRIPLES		2620	3170	3720	4260	4790	5250	5860								
460/85R42		LI					144		150								
	SINGLES		3420	4080	4800	5360	6150	6800	7400								
	DUALS		3010	3590	4220	4720	5410	5980	6510								
	TRIPLES		2800	3350	3940	4400	5040	5580	6070								
480/85R24		LI					127		133		137	140					
	SINGLES		2150	2600	3000	3420	3860	4180	4540	4800	5080	5520					
	DUALS		1890	2290	2640	3010	3400	3680	4000	4220	4470	4860					
	TRIPLES		1760	2130	2460	2800	3170	3430	3720	3940	4170	4530					
480/65R28		LI					130		136								
	SINGLES		2270	2760	3200	3640	4180	4540	4940								
	DUALS		2000	2430	2820	3200	3680	4000	4350								
	TRIPLES		1860	2260	2620	2990	3430	3720	4051								
480/70R24		LI					131		138								
	SINGLES		2340	2830	3300	3740	4300	4680	5200								
	DUALS		2060	2490	2900	3290	3780	4120	4580								
	TRIPLES		1920	2320	2710	3070	3530	3840	4260								
480/70R28		LI					133		140								
	SINGLES		2540	3000	3520	4080	4540	5080	5520								
	DUALS		2240	2640	3100	3590	4000	4470	4860								
	TRIPLES		2080	2460	2890	3350	3720	4170	4530								

FOR RIM AND WHEEL LOAD INFORMATION, SEE IMPORTANT NOTES ON PAGES 168-172.

RADIAL FARM
BIAS FARM
FRONTS & IMPLEMENTS
FORESTRY & FLOTATION
DISCONTINUED
LOAD & INFLATION TABLES
GENERAL TIRE INFORMATION
WARRANTY

TABLE B – METRIC RADIAL PLY AGRICULTURAL TRACTOR DRIVE WHEEL TIRES

BASIC TIRE LOAD RATINGS FOR TIRE SELECTION

METRIC UNITS OF MEASURE (kg@kPa)

TIRE SIZE	INFLATION		LOAD LIMITS AT VARIOUS COLD INFLATION PRESSURES														
	kPa		40	60	80	100	120	140	160	180	200	240	280	320	360	400	440
	bar		0.4	0.6	0.8	1.0	1.2	1.4	1.6	1.8	2.0	2.4	2.8	3.2	3.6	4.0	4.4
LOAD LIMITS IN KG., INFLATION PRESSURE IN kPa																	
420/90R30		LI						135	142	145							
	SINGLES		1215	1450	1700	1900	2180	2430	2650	2800	2900						
	DUALS		1070	1280	1500	1670	1920	2140	2330	2460	2550						
	TRIPLES		1000	1190	1390	1560	1790	1990	2170	2300	2380						
440/65R24		LI						123									
	SINGLES		850	1030	1180	1360	1550	1700	1800								
	DUALS		750	910	1040	1200	1360	1500	1580								
	TRIPLES		700	850	970	1120	1270	1390	1480								
440/65R28		LI						125		131							
	SINGLES		925	1090	1285	1450	1650	1800	1950								
	DUALS		810	960	1130	1280	1450	1580	1720								
	TRIPLES		760	890	1050	1190	1350	1480	1600								
460/85R30		LI						138		145							
	SINGLES		1320	1600	1850	2120	2360	2650	2900								
	DUALS		1160	1410	1630	1870	2080	2330	2550								
	TRIPLES		1080	1310	1520	1740	1940	2170	2380								
460/85R34		LI						140	144	147							
	SINGLES		1400	1650	1950	2240	2500	2800	3075								
	DUALS		1230	1450	1720	1970	2200	2460	2710								
	TRIPLES		1150	1350	1600	1840	2050	2300	2520								
460/85R38		LI						142		149							
	SINGLES		1450	1750	2060	2360	2650	2900	3250								
	DUALS		1280	1540	1810	2080	2330	2550	2860								
	TRIPLES		1190	1440	1690	1940	2170	2380	2670								
460/85R42		LI						144		150							
	SINGLES		1550	1850	2180	2430	2800	3075	3350								
	DUALS		1360	1630	1920	2140	2460	2710	2950								
	TRIPLES		1270	1520	1790	1990	2300	2520	2750								
480/85R24		LI						127		133		137	140				
	SINGLES		975	1180	1360	1550	1750	1900	2060	2180	2300	2500					
	DUALS		860	1040	1200	1360	1540	1670	1810	1920	2020	2200					
	TRIPLES		800	970	1120	1270	1440	1560	1690	1790	1890	2050					
480/65R28		LI						130		136							
	SINGLES		1030	1250	1450	1650	1900	2060	2240								
	DUALS		910	1100	1280	1450	1670	1810	1970								
	TRIPLES		850	1030	1190	1350	1560	1690	1840								
480/70R24		LI						131		138							
	SINGLES		1060	1285	1500	1700	1950	2120	2360								
	DUALS		930	1130	1320	1500	1720	1870	2080								
	TRIPLES		870	1050	1230	1390	1600	1740	1940								
480/70R28		LI						133		140							
	SINGLES		1150	1360	1600	1850	2060	2300	2500								
	DUALS		1010	1200	1410	1630	1810	2020	2200								
	TRIPLES		940	1120	1310	1520	1690	1890	2050								

FOR RIM AND WHEEL LOAD INFORMATION, SEE IMPORTANT NOTES ON PAGES 168-172.

TABLE B – METRIC RADIAL PLY AGRICULTURAL TRACTOR DRIVE WHEEL TIRES

BASIC TIRE LOAD RATINGS FOR TIRE SELECTION

ENGLISH UNITS OF MEASURE (lbs@psi)

TIRE SIZE	INFLATION		LOAD LIMITS AT VARIOUS COLD INFLATION PRESSURES														
	psi	Symbol	6	9	12	15	17	20	23	26	29	35	41	46	52	58	64
	LOAD LIMITS IN LBS., INFLATION PRESSURE IN PSI																
480/70R30		LI					134		141		145	147	150	152			
	SINGLES		2600	3080	3640	4180	4680	5200	5680	6000	6400	6800	7400	7850			
	DUALS		2290	2710	3200	3680	4120	4580	5000	5280	5630	5980	6510	6910			
	TRIPLES		2130	2530	2980	3430	3840	4260	4660	4920	5250	5580	6070	6440			
480/70R34		LI					136		143		146	149	152	155			
	SINGLES		2760	3300	3860	4400	4940	5520	6000	6400	6600	7150	7850	8550			
	DUALS		2430	2900	3400	3870	4350	4860	5280	5630	5810	6290	6910	7520			
	TRIPLES		2260	2710	3170	3610	4050	4530	4920	5250	5410	5860	6440	7010			
480/70R38		LI					138		145								
	SINGLES		2910	3520	4080	4680	5200	5840	6400								
	DUALS		2560	3100	3590	4120	4580	5140	5630								
	TRIPLES		2390	2890	3350	3840	4260	4790	5250								
480/80R30		LI					139		145		149	151	154	156	159		
	SINGLES		2910	3520	4080	4680	5360	5840	6400	6800	7150	7600	8250	8800	9650		
	DUALS		2560	3100	3590	4120	4720	5140	5630	5980	6290	6690	7260	7740	8490		
	TRIPLES		2390	2890	3350	3840	4400	4790	5250	5580	5860	6230	6770	7220	7910		
480/80R38		LI					142		149								
	SINGLES		3300	3960	4540	5200	5840	6600	7150								
	DUALS		2900	3480	4000	4580	5140	5810	6290								
	TRIPLES		2710	3250	3720	4260	4790	5410	5860								
480/80R42		LI					144		151		154						
	SINGLES		3420	4080	4800	5520	6150	6950	7600	8050	8250						
	DUALS		3010	3590	4220	4860	5410	6120	6690	7080	7260						
	TRIPLES		2800	3350	3940	4530	5040	5700	6230	6600	6770						
480/80R46		LI					145		152		155	158					
	SINGLES		3640	4300	5080	5680	6400	7150	7850	8250	8550	9350					
	DUALS		3200	3780	4470	5000	5630	6290	6910	7260	7520	8230					
	TRIPLES		2980	3530	4170	4660	5250	5860	6440	6770	7010	7670					
480/80R50		LI					147		154		157	159					
	SINGLES		3740	4540	5200	6000	6800	7600	8250	8550	9100	9650					
	DUALS		3290	4000	4580	5280	5980	6690	7260	7520	8010	8490					
	TRIPLES		3070	3720	4260	4920	5580	6230	6770	7010	7460	7910					
480/85R34		LI					142		149								
	SINGLES		3300	3960	4540	5200	5840	6600	7150								
	DUALS		2900	3480	4000	4580	5140	5810	6290								
	TRIPLES		2710	3250	3720	4260	4790	5410	5860								
520/70R38		LI					143		150								
	SINGLES		3300	3960	4680	5200	6000	6600	7400								
	DUALS		2900	3480	4120	4580	5280	5810	6510								
	TRIPLES		2710	3250	3840	4260	4920	5410	6070								
520/85R34		LI					146		154		157	159	162				
	SINGLES		3740	4400	5200	6000	6600	7400	8250	8550	9100	9650	10500				
	DUALS		3290	3870	4580	5280	5810	6510	7260	7520	8010	8490	9240				
	TRIPLES		3070	3610	4260	4920	5410	6070	6770	7010	7460	7910	8610				

FOR RIM AND WHEEL LOAD INFORMATION, SEE IMPORTANT NOTES ON PAGES 168-172.

RADIAL FARM

BIAS FARM

FRONTS & IMPLEMENTS

FORESTRY & FLOTATION

DISCONTINUED

LOAD & INFLATION TABLES

GENERAL TIRE INFORMATION

WARRANTY

TABLE B – METRIC RADIAL PLY AGRICULTURAL TRACTOR DRIVE WHEEL TIRES

BASIC TIRE LOAD RATINGS FOR TIRE SELECTION

METRIC UNITS OF MEASURE (kg@kPa)

TIRE SIZE	INFLATION		LOAD LIMITS AT VARIOUS COLD INFLATION PRESSURES															
	kPa		40	60	80	100	120	140	160	180	200	240	280	320	360	400	440	
	bar		0.4	0.6	0.8	1.0	1.2	1.4	1.6	1.8	2.0	2.4	2.8	3.2	3.6	4.0	4.4	
LOAD LIMITS IN KG., INFLATION PRESSURE IN kPa																		
480/70R30		LI					134	141		145	147	150	152					
	SINGLES		1180	1400	1650	1900	2120	2360	2575	2725	2900	3075	3350	3550				
	DUALS		1040	1230	1450	1670	1870	2080	2270	2400	2550	2710	2950	3120				
	TRIPLES		970	1150	1350	1560	1740	1940	2110	2230	2380	2520	2750	2910				
480/70R34		LI					136	143		146	149	152	155					
	SINGLES		1250	1500	1750	2000	2240	2500	2725	2900	3000	3250	3550	3875				
	DUALS		1100	1320	1540	1760	1970	2200	2400	2550	2640	2860	3120	3410				
	TRIPLES		1030	1230	1440	1640	1840	2050	2240	2380	2460	2670	2910	3180				
480/70R38		LI					138	145										
	SINGLES		1320	1600	1850	2120	2360	2650	2900									
	DUALS		1160	1410	1630	1870	2080	2330	2550									
	TRIPLES		1080	1310	1520	1740	1940	2170	2380									
480/80R30		LI					139	145										
	SINGLES		1320	1600	1850	2120	2430	2650	2900	3075	3250	3450	3750	4000	4375			
	DUALS		1160	1410	1630	1870	2140	2330	2550	2710	2860	3040	3300	3520	3850			
	TRIPLES		1080	1310	1520	1740	1990	2170	2380	2520	2670	2830	3080	3280	3590			
480/80R38		LI					142	149										
	SINGLES		1500	1800	2060	2360	2650	3000	3250									
	DUALS		1320	1580	1810	2080	2330	2640	2860									
	TRIPLES		1230	1480	1690	1940	2170	2460	2670									
480/80R42		LI					144	151		154								
	SINGLES		1550	1850	2180	2500	2800	3150	3450	3650	3750							
	DUALS		1360	1630	1920	2200	2460	2770	3040	3210	3300							
	TRIPLES		1270	1520	1790	2050	2300	2580	2830	2990	3080							
480/80R46		LI					145	152		155	158							
	SINGLES		1650	1950	2300	2575	2900	3250	3550	3750	3875	4250						
	DUALS		1450	1720	2020	2270	2550	2860	3120	3300	3410	3740						
	TRIPLES		1350	1600	1890	2110	2380	2670	2910	3080	3180	3490						
480/80R50		LI					147	154		157	159							
	SINGLES		1700	2060	2360	2725	3075	3450	3750	3875	4125	4375						
	DUALS		1500	1810	2080	2400	2710	3040	3300	3410	3630	3850						
	TRIPLES		1390	1690	1940	2230	2520	2830	3080	3180	3380	3590						
480/85R34		LI					142	149										
	SINGLES		1500	1800	2060	2360	2650	3000	3250									
	DUALS		1320	1580	1810	2080	2330	2640	2860									
	TRIPLES		1230	1480	1690	1940	2170	2460	2670									
520/70R38		LI					143	150										
	SINGLES		1500	1800	2120	2360	2725	3000	3350									
	DUALS		1320	1580	1870	2080	2400	2640	2950									
	TRIPLES		1230	1480	1740	1940	2240	2460	2750									
520/85R34		LI					146	154		157	159	162						
	SINGLES		1700	2000	2360	2725	3000	3350	3750	3875	4125	4375	4750					
	DUALS		1500	1760	2080	2400	2640	2950	3300	3410	3630	3850	4180					
	TRIPLES		1390	1640	1940	2230	2460	2750	3080	3180	3380	3590	3900					

FOR RIM AND WHEEL LOAD INFORMATION, SEE IMPORTANT NOTES ON PAGES 168-172.

TABLE B – METRIC RADIAL PLY AGRICULTURAL TRACTOR DRIVE WHEEL TIRES

BASIC TIRE LOAD RATINGS FOR TIRE SELECTION

ENGLISH UNITS OF MEASURE (lbs@psi)

TIRE SIZE	INFLATION		LOAD LIMITS AT VARIOUS COLD INFLATION PRESSURES														
	psi	Symbol	6	9	12	15	17	20	23	26	29	35	41	46	52	58	64
	LOAD LIMITS IN LBS., INFLATION PRESSURE IN PSI																
520/85R38		LI					148		155								
	SINGLES		3860	4680	5520	6150	6950	7850	8550								
	DUALS		3400	4120	4860	5410	6120	6910	7520								
	TRIPLES		3170	3840	4530	5040	5700	6440	7010								
520/85R42		LI					150		157		160	162	165				
	SINGLES		4080	4940	5680	6600	7400	8250	9100	9350	9900	10500	11400				
	DUALS		3590	4350	5000	5810	6510	7260	8010	8230	8710	9240	10030				
	TRIPLES		3350	4050	4660	5410	6070	6770	7460	7670	8120	8610	9350				
520/85R46		LI					151		158								
	SINGLES		4300	5080	6000	6800	7600	8550	9350								
	DUALS		3780	4470	5280	5980	6690	7520	8230								
	TRIPLES		3530	4170	4920	5580	6230	7010	7670								
540/65R24		LI					134		140								
	SINGLES		2600	3080	3640	4080	4680	5080	5520								
	DUALS		2290	2710	3200	3590	4120	4470	4860								
	TRIPLES		2130	2530	2980	3350	3840	4170	4530								
540/65R28		LI					136		142								
	SINGLES		2760	3300	3860	4400	4940	5520	5840								
	DUALS		2430	2900	3400	3870	4350	4860	5140								
	TRIPLES		2260	2710	3170	3610	4050	4530	4790								
540/65R30		LI					137		143		147	150					
	SINGLES		2830	3420	3960	4540	5080	5680	6000	6400	6800	7400					
	DUALS		2490	3010	3480	4000	4470	5000	5280	5630	5980	6510					
	TRIPLES		2320	2800	3250	3720	4170	4660	4920	5250	5580	6070					
540/65R34		LI					140		145		149	152					
	SINGLES		3000	3640	4180	4800	5520	6000	6400	6800	7150	7850					
	DUALS		2640	3200	3680	4220	4860	5280	5630	5980	6290	6910					
	TRIPLES		2460	2980	3430	3940	4530	4920	5250	5580	5860	6440					
540/65R38		LI					141		147								
	SINGLES		3200	3860	4400	5080	5680	6150	6800								
	DUALS		2820	3400	3870	4470	5000	5410	5980								
	TRIPLES		2620	3170	3610	4170	4660	5040	5580								
580/85R42		LI					156		163		166	168					
	SINGLES		4800	5840	6800	7850	8800	9650	10700	11000	11700	12300					
	DUALS		4220	5140	5980	6910	7740	8490	9420	9680	10300	10820					
	TRIPLES		3940	4790	5580	6440	7220	7910	8770	9020	9590	10080					
600/65R28		LI					142		147		152	154					
	SINGLES		3300	3860	4540	5200	5840	6400	6800	7400	7850	8250					
	DUALS		2900	3400	4000	4580	5140	5630	5980	6510	6910	7260					
	TRIPLES		2710	3170	3720	4260	4790	5250	5580	6070	6440	6770					
600/65R34		LI					145		152								
	SINGLES		3520	4300	4940	5680	6400	6950	7600								
	DUALS		3100	3780	4350	5000	5630	6120	6690								
	TRIPLES		2890	3530	4050	4660	5250	5700	6230								

FOR RIM AND WHEEL LOAD INFORMATION, SEE IMPORTANT NOTES ON PAGES 168-172.

RADIAL FARM
BIAS FARM
FRONTS & IMPLEMENTS
FORESTRY & FLOTATION
DISCONTINUED
LOAD & INFLATION TABLES
GENERAL TIRE INFORMATION
WARRANTY

TABLE B – METRIC RADIAL PLY AGRICULTURAL TRACTOR DRIVE WHEEL TIRES

BASIC TIRE LOAD RATINGS FOR TIRE SELECTION

METRIC UNITS OF MEASURE (kg@kPa)

TIRE SIZE	INFLATION		LOAD LIMITS AT VARIOUS COLD INFLATION PRESSURES														
	kPa		40	60	80	100	120	140	160	180	200	240	280	320	360	400	440
	bar		0.4	0.6	0.8	1.0	1.2	1.4	1.6	1.8	2.0	2.4	2.8	3.2	3.6	4.0	4.4
LOAD LIMITS IN KG., INFLATION PRESSURE IN kPa																	
520/85R38		LI						148	155								
	SINGLES		1750	2120	2500	2800	3150	3550	3875								
	DUALS		1540	1870	2200	2460	2770	3120	3410								
	TRIPLES		1440	1740	2050	2300	2580	2910	3180								
520/85R42		LI						150	157		160	162	165				
	SINGLES		1850	2240	2575	3000	3350	3750	4125	4250	4500	4750	5150				
	DUALS		1630	1970	2270	2640	2950	3300	3630	3740	3960	4180	4530				
	TRIPLES		1520	1840	2110	2460	2750	3080	3380	3490	3690	3900	4220				
520/85R46		LI						151	158								
	SINGLES		1950	2300	2725	3075	3450	3875	4250								
	DUALS		1720	2020	2400	2710	3040	3410	3740								
	TRIPLES		1600	1890	2230	2520	2830	3180	3490								
540/65R24		LI						134	140								
	SINGLES		1180	1400	1650	1850	2120	2300	2500								
	DUALS		1040	1230	1450	1630	1870	2020	2200								
	TRIPLES		970	1150	1350	1520	1740	1890	2050								
540/65R28		LI						136	142								
	SINGLES		1250	1500	1750	2000	2240	2500	2650								
	DUALS		1100	1320	1540	1760	1970	2200	2330								
	TRIPLES		1030	1230	1440	1640	1840	2050	2170								
540/65R30		LI						137	143		147	150					
	SINGLES		1285	1550	1800	2060	2300	2575	2725	2900	3075	3350					
	DUALS		1130	1360	1580	1810	2020	2270	2400	2550	2710	2950					
	TRIPLES		1050	1270	1480	1690	1890	2110	2230	2380	2520	2750					
540/65R34		LI						140	145		149	152					
	SINGLES		1360	1650	1900	2180	2500	2725	2900	3075	3250	3550					
	DUALS		1200	1450	1670	1920	2200	2400	2550	2710	2860	3120					
	TRIPLES		1120	1350	1560	1790	2050	2230	2380	2520	2670	2910					
540/65R38		LI						141	147								
	SINGLES		1450	1750	2000	2300	2575	2800	3075								
	DUALS		1280	1540	1760	2020	2270	2460	2710								
	TRIPLES		1190	1440	1640	1890	2110	2300	2520								
580/85R42		LI						156	163		166	168					
	SINGLES		2180	2650	3075	3550	4000	4375	4875	5000	5300	5600					
	DUALS		1920	2330	2710	3120	3520	3850	4290	4400	4660	4930					
	TRIPLES		1790	2170	2520	2910	3280	3590	4000	4100	4350	4590					
600/65R28		LI						142	148		152	154					
	SINGLES		1500	1750	2060	2360	2650	2900	3150	3350	3550	3750					
	DUALS		1320	1540	1810	2080	2330	2550	2770	2950	3120	3300					
	TRIPLES		1230	1440	1690	1940	2170	2380	2580	2750	2910	3080					
600/65R34		LI						145	151								
	SINGLES		1600	1950	2240	2575	2900	3150	3450								
	DUALS		1410	1720	1970	2270	2550	2770	3040								
	TRIPLES		1310	1600	1840	2110	2380	2580	2830								

FOR RIM AND WHEEL LOAD INFORMATION, SEE IMPORTANT NOTES ON PAGES 168-172.

TABLE B – METRIC RADIAL PLY AGRICULTURAL TRACTOR DRIVE WHEEL TIRES

BASIC TIRE LOAD RATINGS FOR TIRE SELECTION

ENGLISH UNITS OF MEASURE (lbs@psi)

TIRE SIZE	INFLATION		LOAD LIMITS AT VARIOUS COLD INFLATION PRESSURES														
	psi	Symbol	6	9	12	15	17	20	23	26	29	35	41	46	52	58	64
	LOAD LIMITS IN LBS., INFLATION PRESSURE IN PSI																
600/65R38		LI					147		153		156	159	162	165			
	SINGLES		3740	4540	5200	6000	6800	7400	8050	8550	8800	9650	10500	11400			
	DUALS		3290	4000	4580	5280	5980	6510	7080	7520	7740	8490	9240	10030			
	TRIPLES		3070	3720	4260	4920	5580	6070	6600	7010	7220	7910	8610	9350			
600/70R28		LI					145		152		155	157	161	164			
	SINGLES		3640	4300	5080	5680	6400	7150	7850	8250	8550	9100	10200	11000			
	DUALS		3200	3780	4470	5000	5630	6290	6910	7260	7520	8000	8980	9680			
	TRIPLES		2980	3530	4170	4660	5250	5860	6440	6770	7010	7460	8360	9020			
600/70R30		LI					146		152		156	158	162				
	SINGLES		3640	4400	5200	5840	6600	7400	7850	8550	8800	9350	10500				
	DUALS		3200	3870	4580	5140	5810	6510	6910	7520	7740	8230	9240				
	TRIPLES		2980	3610	4260	4790	5410	6070	6440	7010	7220	7670	8610				
620/70R42		LI					153		160		164	166					
	SINGLES		4540	5360	6400	7150	8050	9100	9900	10500	11000	11700					
	DUALS		4000	4720	5630	6290	7080	8010	8710	9240	9680	10300					
	TRIPLES		3720	4400	5250	5860	6600	7460	8120	8610	9020	9590					
620/70R46		LI					155		162		165	167	170	173	175	177	180
	SINGLES		4680	5680	6600	7600	8550	9350	10500	11000	11400	12000	13200	14300	15200	16100	17600
	DUALS		4120	5000	5800	6700	7500	8250	9250	9700	10000	10600	11600	12600	13400	14200	15500
	TRIPLES		3840	4660	5420	6250	7000	7650	8600	9000	9350	9850	10800	11700	12500	13200	14400
620/75R30		LI					150		157		160	163					
	SINGLES		4180	4940	5840	6600	7400	8250	9100	9650	9900	10700					
	DUALS		3680	4350	5140	5810	6510	7260	8010	8490	8710	9420					
	TRIPLES		3430	4050	4790	5410	6070	6770	7460	7910	8120	8770					
650/65R38		LI					151		157		160	163	166				
	SINGLES		4180	5080	5840	6800	7600	8250	9100	9650	9900	10700	11700				
	DUALS		3680	4470	5140	5980	6690	7260	8000	8500	8712	9416	10296				
	TRIPLES		3430	4170	4790	5580	6230	6770	7460	7910	8120	8770	9600				
650/65R42		LI					153		158								
	SINGLES		4400	5360	6150	7150	8050	8800	9350								
	DUALS		3870	4720	5410	6290	7080	7740	8230								
	TRIPLES		3610	4400	5040	5860	6600	7220	7670								
650/75R32		LI					154		160		164	167	169	172			
	SINGLES		4540	5520	6400	7400	8250	9100	9900	10700	11000	12000	12800	13900			
	DUALS		4000	4860	5630	6510	7260	8010	8700	9420	9680	10600	11260	12230			
	TRIPLES		3720	4530	5250	6070	6770	7460	8100	8770	9020	9850	10500	11400			
650/85R38		LI					160		167		170	173					
	SINGLES		5520	6600	7850	8800	9900	11000	12000	12800	13200	14300					
	DUALS		4860	5810	6910	7740	8710	9680	10560	11260	11620	12580					
	TRIPLES		4530	5410	6440	7220	8120	9020	9840	10500	10820	11730					
710/70R38		LI					159		166		169	171					
	SINGLES		5360	6400	7400	8550	9650	10700	11700	12300	12800	13600					
	DUALS		4720	5630	6510	7520	8490	9420	10300	10820	11260	11970					
	TRIPLES		4400	5250	6070	7010	7910	8770	9590	10090	10500	11150					

FOR RIM AND WHEEL LOAD INFORMATION, SEE IMPORTANT NOTES ON PAGES 168-172.

RADIAL FARM

BIAS FARM

FRONTS & IMPLEMENTS

FORESTRY & FLOTATION

DISCONTINUED

LOAD & INFLATION TABLES

GENERAL TIRE INFORMATION

WARRANTY

TABLE B – METRIC RADIAL PLY AGRICULTURAL TRACTOR DRIVE WHEEL TIRES

BASIC TIRE LOAD RATINGS FOR TIRE SELECTION

METRIC UNITS OF MEASURE (kg@kPa)

TIRE SIZE	INFLATION		LOAD LIMITS AT VARIOUS COLD INFLATION PRESSURES															
	kPa		40	60	80	100	120	140	160	180	200	240	280	320	360	400	440	
	bar		0.4	0.6	0.8	1.0	1.2	1.4	1.6	1.8	2.0	2.4	2.8	3.2	3.6	4.0	4.4	
LOAD LIMITS IN KG., INFLATION PRESSURE IN kPa																		
600/65R38		LI					147		153		156	159	162	165				
		SINGLES	1700	2060	2360	2725	3075	3350	3650	3875	4000	4375	4750	5150				
		DUALS	1500	1810	2080	2400	2710	2950	3210	3410	3520	3850	4180	4530				
		TRIPLES	1390	1690	1940	2230	2520	2750	2990	3180	3280	3590	3900	4220				
600/70R28		LI					145		152		155	157	161	164				
		SINGLES	1650	1950	2300	2575	2900	3250	3550	3750	3875	4125	4625	5000				
		DUALS	1450	1720	2020	2270	2550	2860	3120	3300	3410	3630	4070	4400				
		TRIPLES	1350	1600	1890	2110	2380	2670	2910	3080	3180	3380	3800	4100				
600/70R30		LI					146		153		156	158	162					
		SINGLES	1650	2000	2360	2650	3000	3350	3650	3875	4000	4250	4750					
		DUALS	1450	1760	2080	2330	2640	2950	3210	3410	3520	3740	4180					
		TRIPLES	1350	1640	1940	2170	2460	2750	2990	3180	3280	3490	3900					
620/70R42		LI					153		160		164	166						
		SINGLES	2060	2430	2900	3250	3650	4125	4500	4750	5000	5300						
		DUALS	1810	2140	2550	2860	3210	3630	3960	4180	4400	4660						
		TRIPLES	1690	1990	2380	2670	2990	3380	3690	3900	4100	4350						
620/70R46		LI	2120	2575	3000	3450	3875	4250	4750	5000	5150	5450	6000	6500	6900	7300	8000	
		SINGLES	1870	2270	2640	3040	3420	3740	4180	4400	4540	4800	5280	5720	6050	6400	7050	
		DUALS	1740	2110	2460	2830	3180	3480	3900	4100	4220	4460	4920	5340	5660	5980	6550	
		TRIPLES																
620/75R30		LI					150		157		160	163						
		SINGLES	1900	2240	2650	3000	3350	3750	4125	4375	4500	4875						
		DUALS	1670	1970	2330	2640	2950	3300	3630	3850	3960	4290						
		TRIPLES	1560	1840	2170	2460	2750	3080	3380	3590	3690	4000						
650/65R38		LI					151		157		160	163	166					
		SINGLES	1900	2300	2650	3075	3450	3750	4125	4375	4500	4875	5300					
		DUALS	1670	2020	2330	2710	3040	3300	3630	3850	3960	4290	4660					
		TRIPLES	1560	1890	2170	2520	2830	3080	3380	3590	3690	4000	4350					
650/65R42		LI					153		158									
		SINGLES	2000	2430	2800	3250	3650	4000	4250									
		DUALS	1760	2140	2460	2860	3210	3520	3740									
		TRIPLES	1640	1990	2300	2670	2990	3280	3470									
650/75R32		LI					154		160		164	167	169	172				
		SINGLES	2060	2500	2900	3350	3750	4125	4500	4875	5000	5450	5800	6300				
		DUALS	1810	2200	2550	2950	3300	3630	3960	4290	4400	4800	5100	5540				
		TRIPLES	1690	2050	2380	2750	3080	3380	3700	4000	4100	4460	4760	5170				
650/85R38		LI					160		167		170	173						
		SINGLES	2500	3000	3550	4000	4500	5000	5450	5800	6000	6500						
		DUALS	2200	2640	3120	3520	3960	4400	4800	5100	5280	5720						
		TRIPLES	2050	2460	2910	3280	3690	4100	4470	4760	4920	5330						
710/70R38		LI					159		166		169	171						
		SINGLES	2430	2900	3350	3875	4375	4875	5300	5600	5800	6150						
		DUALS	2140	2550	2950	3410	3850	4290	4660	4930	5100	5410						
		TRIPLES	1990	2380	2750	3180	3590	4000	4350	4590	4760	5040						

FOR RIM AND WHEEL LOAD INFORMATION, SEE IMPORTANT NOTES ON PAGES 168-172.

RADIAL FARM

BIAS FARM

FRONTS & IMPLEMENTS

FORESTRY & FLOTATION

DISCONTINUED

LOAD & INFLATION TABLES

GENERAL TIRE INFORMATION

WARRANTY

TABLE B – METRIC RADIAL PLY AGRICULTURAL TRACTOR DRIVE WHEEL TIRES

BASIC TIRE LOAD RATINGS FOR TIRE SELECTION

ENGLISH UNITS OF MEASURE (bs@psi)

TIRE SIZE	INFLATION psi Symbol	LOAD LIMITS AT VARIOUS COLD INFLATION PRESSURES														
		6	9	12	15	17	20	23	26	29	35	41	46	52	58	64
		LOAD LIMITS IN KG., INFLATION PRESSURE IN kPa														
710/70R42	LI					160		168		171	173					
	SINGLES	5520	6600	7850	8800	9900	11000	12300	12800	13600	14300					
	DUALS	4860	5810	6910	7740	8710	9680	10820	11260	11970	12580					
	TRIPLES	4530	5410	6440	7220	8120	9020	10090	10500	11150	11730					
710/75R34	LI					159		167		170	172					
	SINGLES	5360	6400	7600	8550	9650	10700	12000	12300	13200	13900					
	DUALS	4720	5630	6690	7520	8490	9420	10560	10820	11620	12230					
	TRIPLES	4400	5250	6230	7010	7910	8770	9840	10090	10820	11400					
750/65R26	LI					153		159		163	166	169				
	SINGLES	4540	5360	6400	7150	8050	8800	9650	10200	10700	11700	12800				
	DUALS	4000	4720	5630	6290	7080	7740	8490	8980	9420	10300	11260				
	TRIPLES	3720	4400	5250	5860	6600	7220	7910	8360	8770	9590	10500				
800/65R32	LI					159		166		169	172					
	SINGLES	5360	6600	7600	8800	9650	10700	11700	12300	12800	13900					
	DUALS	4720	5810	6690	7740	8490	9420	10300	10820	11260	12230					
	TRIPLES	4400	5410	6230	7220	7910	8770	9590	10090	10500	11400					
800/70R38	LI					166		173		176	178	181				
	SINGLES	6400	7600	9100	10200	11700	12800	14300	14800	15700	16500	18200				
	DUALS	5630	6690	8010	8980	10300	11260	12580	13020	13820	14520	16020				
	TRIPLES	5250	6230	7460	8360	9590	10500	11730	12140	12870	13530	14920				
900/50R42	LI					161		168								
	SINGLES	5680	6800	7850	9100	10200	11400	12300								
	DUALS	5000	5980	6910	8010	8980	10030	10820								
	TRIPLES	4660	5580	6440	7460	8360	9350	10090								
900/60R32	LI					163		169		173	176					
	SINGLES	5840	7150	8250	9350	10700	11700	12800	13900	14300	15700					
	DUALS	5140	6290	7260	8230	9420	10300	11260	12230	12580	13820					
	TRIPLES	4790	5860	6770	7670	8770	9590	10500	11400	11730	12870					
900/65R32	LI					166		172		176	178					
	SINGLES	6600	7850	9100	10500	11700	12800	13900	14800	15700	16500					
	DUALS	5810	6910	8010	9240	10300	11260	12230	13020	13820	14520					
	TRIPLES	5410	6440	7460	8610	9590	10500	11400	12140	12870	13530					
900/75R32	LI					172		179		182	184					
	SINGLES	7850	9350	10700	12300	13900	15700	17100	17600	18700	19800					
	DUALS	6910	8230	9420	10820	12230	13820	15050	15490	16460	17420					
	TRIPLES	6440	7670	8770	10090	11400	12870	14020	14430	15330	16240					

FOR RIM AND WHEEL LOAD INFORMATION, SEE IMPORTANT NOTES ON PAGES 168-172.

RADIAL FARM

BIAS FARM

FRONTS & IMPLEMENTS

FORESTRY & FLOTATION

DISCONTINUED

LOAD & INFLATION TABLES

GENERAL TIRE INFORMATION

WARRANTY

TABLE B – METRIC RADIAL PLY AGRICULTURAL TRACTOR DRIVE WHEEL TIRES

BASIC TIRE LOAD RATINGS FOR TIRE SELECTION

METRIC UNITS OF MEASURE (kg@kPa)

TIRE SIZE	INFLATION psi Symbol	LOAD LIMITS AT VARIOUS COLD INFLATION PRESSURES														
		6	9	12	15	17	20	23	26	29	35	41	46	52	58	64
		LOAD LIMITS IN KG., INFLATION PRESSURE IN kPa														
710/70R42	LI					160		168		171	173					
	SINGLES	2500	3000	3550	4000	4500	5000	5600	5800	6150	6500					
	DUALS	2200	2640	3120	3520	3960	4400	4930	5100	5410	5720					
	TRIPLES	2050	2460	2910	3280	3690	4100	4590	4760	5040	5330					
710/75R34	LI					159		167		170	172					
	SINGLES	2430	2900	3450	3875	4375	4875	5450	5600	6000	6300					
	DUALS	2140	2550	3040	3410	3850	4290	4800	4930	5280	5540					
	TRIPLES	1990	2380	2830	3180	3590	4000	4470	4590	4920	5170					
750/65R26	LI					153		159		163	166	169				
	SINGLES	2060	2430	2900	3250	3650	4000	4375	4625	4875	5300	5800				
	DUALS	1810	2140	2550	2860	3210	3520	3850	4070	4290	4660	5100				
	TRIPLES	1690	1990	2380	2670	2990	3280	3590	3790	4000	4350	4760				
800/65R32	LI					159		166		169	172					
	SINGLES	2430	3000	3450	4000	4375	4875	5300	5600	5800	6300					
	DUALS	2140	2640	3040	3520	3850	4290	4660	4930	5100	5540					
	TRIPLES	1990	2460	2830	3280	3590	4000	4350	4590	4760	5170					
800/70R38	LI					166		173		176	178	181				
	SINGLES	2900	3450	4125	4625	5300	5800	6500	6700	7100	7500	8250				
	DUALS	2550	3040	3630	4070	4660	5100	5720	5900	6250	6600	7260				
	TRIPLES	2380	2830	3380	3790	4350	4760	5330	5490	5820	6150	6770				
900/50R42	LI					161		168								
	SINGLES	2575	3075	3550	4125	4625	5150	5600								
	DUALS	2270	2710	3120	3630	4070	4530	4930								
	TRIPLES	2110	2520	2910	3380	3790	4220	4590								
900/60R32	LI					166		172		176	178					
	SINGLES	3000	3550	4125	4750	5300	5800	6300	6700	7100	7500					
	DUALS	2640	3120	3630	4180	4660	5100	5540	5900	6250	6600					
	TRIPLES	2460	2910	3380	3900	4350	4760	5170	5490	5820	6150					
900/65R32	LI					166		172		176	178					
	SINGLES	6600	7850	9100	10500	11700	12800	13900	14800	15700	16500					
	DUALS	5810	6910	8010	9240	10300	11260	12230	13020	13820	14520					
	TRIPLES	5410	6440	7460	8610	9590	10500	11400	12140	12870	13530					
900/75R32	LI					172		179		182	184					
	SINGLES	3550	4250	4875	5600	6300	7100	7750	8000	8500	9000					
	DUALS	3120	3740	4290	4930	5540	6250	6820	7040	7480	7920					
	TRIPLES	2910	3490	4000	4590	5170	5820	6360	6560	6970	7380					

FOR RIM AND WHEEL LOAD INFORMATION, SEE IMPORTANT NOTES ON PAGES 168-172.

RADIAL FARM
BIAS FARM
FRONTS & IMPLEMENTS
FORESTRY & FLOTATION
DISCONTINUED
LOAD & INFLATION TABLES
GENERAL TIRE INFORMATION
WARRANTY

TABLE B — METRIC RADIAL PLY AGRICULTURAL TRACTOR DRIVE WHEEL TIRES

BASIC TIRE LOAD RATINGS FOR TIRE SELECTION

ENGLISH UNITS OF MEASURE (lbs@psi)

TIRE SIZE	INFLATION		LOAD LIMITS AT VARIOUS COLD INFLATION PRESSURES														
	psi	Symbol	6	9	12	15	17	20	23	26	29	35	41	46	52	58	64
	LOAD LIMITS IN LBS., INFLATION PRESSURE IN PSI																
1050/50R25	SINGLES	LI	5840	6950	8050	9350	10500	11700	12800	13600	14300						
	DUALS		5140	6120	7080	8230	9240	10300	11260	11970	12580						
	TRIPLES		4790	5700	6600	7670	8610	9590	10500	11150	11730						

NOTES:

- For shipping purposes, tire inflation pressures may be increased to 30 psi (210 kPa). Inflation pressure must be adjusted to correct operating inflation before placing tires in service.
- For transport service above 20 mph (30 km/h), recommended minimum inflation pressure is 8 psi (60 kPa).
- For tires used in cyclic loading service, see Table F1 on pages 195-196.
- For transport service and operations that do not require sustained high torque, the load limits shown at right at various speeds apply with no change in inflation pressure.

Speed Symbol	Service Speed	% Change to loads in above		
		A8	B	D
A8	Stationary	+130%	+130%	+130%
	15 km/h [10 mph]	+34%	+34%	+34%
	25 km/h [15 mph]	+11%	+11%	+18.5%
	30 km/h [25 mph]	+7%	+7%	+15%
	40 km/h [25 mph]	None	None	+9.5%
B	50 km/h [30 mph]	-	None	+5%
D	65 km/h [40 mph]	-	-	None

RADIAL FARM

BIAS FARM

FRONTS & IMPLEMENTS

FORESTRY & FLOTATION

DISCONTINUED

LOAD & INFLATION TABLES

GENERAL TIRE INFORMATION

WARRANTY

FOR RIM AND WHEEL LOAD INFORMATION, SEE IMPORTANT NOTES ON PAGES 168-172.

TABLE B – METRIC RADIAL PLY AGRICULTURAL TRACTOR DRIVE WHEEL TIRES

BASIC TIRE LOAD RATINGS FOR TIRE SELECTION

METRIC UNITS OF MEASURE (kg@kPa)

TIRE SIZE	INFLATION		LOAD LIMITS AT VARIOUS COLD INFLATION PRESSURES														
	kPa		40	60	80	100	120	140	160	180	200	240	280	320	360	400	440
	bar		0.4	0.6	0.8	1.0	1.2	1.4	1.6	1.8	2.0	2.4	2.8	3.2	3.6	4.0	4.4
LOAD LIMITS IN KG., INFLATION PRESSURE IN kPa																	
	LI					162	169		173								
1050/50R25	SINGLES		2650	3150	3650	4240	4760	5300	5800	6170	6490						
	DUALS		2330	2770	3210	3730	4190	4660	5100	5429.6	5710						
	TRIPLES		2170	2580	3000	3480	3900	4350	4760	5060	5320						

NOTES:

- For shipping purposes, tire inflation pressures may be increased to 30 psi (210 kPa). Inflation pressure must be adjusted to correct operating inflation before placing tires in service.
- For transport service above 20 mph (30 km/h), recommended minimum inflation pressure is 8 psi (60 kPa).
- For tires used in cyclic loading service, see Table F1 on pages 195-196.
- For transport service and operations that do not require sustained high torque, the load limits shown at right at various speeds apply with no change in inflation pressure.

Speed Symbol	Service Speed	% Change to loads in above		
		A8	B	D
A8	Stationary	+130%	+130%	+130%
	15 km/h [10 mph]	+34%	+34%	+34%
	25 km/h [15 mph]	+11%	+11%	+18.5%
	30 km/h [25 mph]	+7%	+7%	+15%
	40 km/h [25 mph]	None	None	+9.5%
B	50 km/h [30 mph]	-	None	+5%
D	65 km/h [40 mph]	-	-	None

FOR RIM AND WHEEL LOAD INFORMATION, SEE IMPORTANT NOTES ON PAGES 168-172.

TABLE C – AD₂ IF LOAD DESIGNATION FOR RADIAL AGRICULTURAL DRIVE WHEEL TIRES

TIRE TYPE NOMENCLATURE		MAX SPEED	
TRA	TIRE TYPE	A/B	D
R-1	Drive Wheel, Regular Tread	30 mph	40 mph
R-1W	Drive Wheel, Wet Traction Tread	30 mph	40 mph
R-2	Cane & Rice, Drive Wheel, Deep Tread	30 mph	—

BASIC TIRE LOAD RATINGS FOR TIRE SELECTION ENGLISH UNITS OF MEASURE (lbs@psi)

TIRE SIZE	INFLATION	psi Symbol	LOAD LIMITS AT VARIOUS COLD INFLATION PRESSURES															
			6	9	12	15	17	20	23	26	29	35	41	46	52	58	64	70
			LOAD LIMITS IN LBS., INFLATION PRESSURE IN PSI															
AD ₂ IF380/80R38	LI						136		143		146	149						
	SINGLES		2270	3300	3860	4400	4940	5520	6000	6400	6600	7150						
	DUALS		2000	2900	3400	3870	4350	4860	5280	5630	5810	6290						
AD ₂ IF380/85R34	LI					132	136		143		146	149						
	SINGLES		2760	3300	3860	4400	4940	5520	6000	6400	6600	7150						
	DUALS		2430	2900	3400	3880	4340	4860	5280	5640	5800	6300						
AD ₂ IF380/90R46	LI					143		150	152	153	155	158	161	163	165	168		
	SINGLES		3300	4080	4680	5360	6000	6800	7400	7850	8050	8550	9350	10200	10700	11400	12300	
	DUALS		2900	3590	4120	4720	5280	5980	6510	6910	7080	7520	8230	8980	9420	10030	10820	
AD ₂ IF380/95R38	LI					137	141		148		151	154						
	SINGLES		3200	3860	4400	5080	5680	6400	6950	7400	7600	8250						
	DUALS		2820	3400	3870	4470	5000	5630	6120	6510	6690	7260						
AD ₂ IF380/105R50	LI					145	149		156		159	161	165	167	169	171	174	177
	SINGLES		3960	4800	5520	6400	7150	8050	8800	9100	9650	10200	11400	12000	12800	13600	14800	16100
	DUALS		3480	4220	4860	5630	6290	7080	7740	8010	8490	8980	10030	10560	11260	11970	13020	14170
AD ₂ IF420/80R46	LI					141	145		152		155	157	160	163	165	167		
	SINGLES		3520	4180	4940	5680	6400	7150	7850	8250	8550	9100	9900	10700	11400	12000		
	DUALS		3100	3680	4350	5000	5630	6290	6910	7260	7520	8010	8710	9420	10030	10560		
AD ₂ IF420/85R34	LI					142		148		152								
	SINGLES		2680	3860	4540	5080	5840	6400	6950	7400	7850							
	DUALS		2360	3400	4000	4470	5140	5630	6120	6510	6910							
AD ₂ IF420/85R38	LI					143		150		153								
	SINGLES		2830	4080	4680	5360	6000	6800	7400	7850	8050							
	DUALS		2490	3590	4120	4720	5280	5980	6510	6910	7080							
AD ₂ IF420/90R30	LI					137	141		148		151							
	SINGLES		3200	3860	4400	5080	5680	6400	6950	7400	7600							
	DUALS		2820	3400	3880	4480	5000	5640	6100	6500	6700							
AD ₂ IF420/90R30	LI					137	141		148		151							
	SINGLES		3200	3860	4400	5080	5680	6400	6950	7400	7600							
	DUALS		2820	3400	3880	4480	5000	5640	6100	6500	6700							

FOR RIM AND WHEEL LOAD INFORMATION, SEE IMPORTANT NOTES ON PAGES 168-172.

RADIAL FARM
 BIAS FARM
 FRONTS & IMPLEMENTS
 FORESTRY & FLOTATION
 DISCONTINUED
 LOAD & INFLATION TABLES
 GENERAL TIRE INFORMATION
 WARRANTY

TABLE C – AD₂ IF LOAD DESIGNATION FOR RADIAL AGRICULTURAL DRIVE WHEEL TIRES

TIRE TYPE NOMENCLATURE		MAX SPEED	
TRA	TIRE TYPE	A8/B	D
R-1	Drive Wheel, Regular Tread	50 km/h	65 km/h
R-1W	Drive Wheel, Wet Traction Tread	50 km/h	65 km/h
R-2	Cane & Rice, Drive Wheel, Deep Tread	50 km/h	—

BASIC TIRE LOAD RATINGS FOR TIRE SELECTION METRIC UNITS OF MEASURE (kg@kPa)

TIRE SIZE	INFLATION		LOAD LIMITS AT VARIOUS COLD INFLATION PRESSURES															
	kPa		40	60	80	100	120	140	160	180	200	240	280	320	360	400	440	480
	bar		0.4	0.6	0.8	1.0	1.2	1.4	1.6	1.8	2.0	2.4	2.8	3.2	3.6	4.0	4.4	4.8
LOAD LIMITS IN KG., INFLATION PRESSURE IN kPa																		
AD ₂ IF380/80R38		LI					136		143		146	149						
	SINGLES		1030	1500	1750	2000	2240	2500	2725	2900	3000	3250						
	DUALS		910	1320	1540	1760	1970	2200	2400	2550	2640	2860						
	TRIPLES		840	1230	1440	1640	1840	2050	2230	2380	2460	2670						
AD ₂ IF380/85R34		LI				132	136		143		146	149						
	SINGLES		1250	1500	1750	2000	2240	2500	2730	2900	3000	3260						
	DUALS		1100	1320	1540	1760	1970	2200	2400	2550	2640	2860						
	TRIPLES		1030	1230	1440	1640	1840	2050	2230	2380	2460	2670						
AD ₂ IF380/90R46		LI				143		150		153	155	158	161	163	165	168		
	SINGLES		1500	1850	2120	2430	2725	3075	3350	3550	3650	3875	4250	4625	4875	5150	5600	
	DUALS		1320	1630	1870	2140	2400	2710	2950	3120	3210	3410	3740	4070	4290	4530	4930	
	TRIPLES		1230	1520	1740	1990	2230	2520	2750	2910	2990	3180	3490	3790	4000	4220	4590	
AD ₂ IF380/95R38		LI				137	141		148		151	154						
	SINGLES		1450	1750	2000	2300	2575	2900	3150	3350	3450	3750						
	DUALS		1280	1540	1760	2020	2270	2550	2770	2950	3040	3300						
	TRIPLES		1190	1440	1640	1890	2110	2380	2580	2750	2830	3075						
AD ₂ IF380/105R50		LI				149		156		159	161	165	167	169	171	174	177	
	SINGLES		1800	2180	2500	2900	3250	3650	4000	4125	4375	4625	5150	5450	5800	6150	6700	7300
	DUALS		1580	1920	2200	2550	2860	3210	3520	3630	3850	4070	4530	4800	5100	5410	5900	6420
	TRIPLES		1480	1790	2050	2380	2670	2990	3280	3380	3590	3790	4220	4470	4760	5040	5490	5990
AD ₂ IF420/80R46		LI				141	145		152		155	157	160	163	165	167		
	SINGLES		1600	1900	2240	2575	2900	3250	3550	3750	3875	4125	4500	4875	5150	5450		
	DUALS		1410	1670	1970	2270	2550	2860	3120	3300	3410	3630	3960	4290	4530	4800		
	TRIPLES		1310	1560	1840	2110	2380	2670	2910	3080	3180	3380	3690	4000	4220	4470		
AD ₂ IF420/85R34		LI				142		148		152								
	SINGLES		1215	1750	2060	2300	2650	2900	3150	3350	3550							
	DUALS		1070	1540	1810	2020	2330	2550	2770	2950	3120							
	TRIPLES		1000	1440	1690	1890	2170	2380	2580	2750	2910							
AD ₂ IF420/85R38		LI				143		150		153								
	SINGLES		1285	1850	2120	2430	2725	3075	3350	3550	3650							
	DUALS		1130	1630	1870	2140	2400	2710	2950	3120	3210							
	TRIPLES		1050	1520	1740	1990	2230	2520	2750	2910	2990							
AD ₂ IF420/90R30		LI				137	141		148		151							
	SINGLES		1450	1750	2000	2300	2580	2900	3160	3360	3460							
	DUALS		1280	1540	1760	2020	2270	2550	2770	2950	3040							
	TRIPLES		1190	1440	1640	1890	2110	2380	2580	2750	2830							

FOR RIM AND WHEEL LOAD INFORMATION, SEE IMPORTANT NOTES ON PAGES 168-172.

TABLE C – AD₂ IF LOAD DESIGNATION FOR RADIAL AGRICULTURAL DRIVE WHEEL TIRES

BASIC TIRE LOAD RATINGS FOR TIRE SELECTION

ENGLISH UNITS OF MEASURE (lbs@psi)

TIRE SIZE	INFLATION		LOAD LIMITS AT VARIOUS COLD INFLATION PRESSURES															
	psi	Symbol	6	9	12	15	17	20	23	26	29	35	41	46	52	58	64	70
	LOAD LIMITS IN LBS., INFLATION PRESSURE IN PSI																	
AD ₂ IF480/80R46		LI				148	152		158		162	164						
	SINGLES		4300	5200	6000	6950	7850	8550	9350	9900	10500	11000						
	DUALS		3780	4580	5280	6100	6900	7500	8250	8700	9250	9700						
	TRIPLES		3520	4260	4920	5700	6450	7000	7650	8100	8600	9000						
AD ₂ IF480/80R50		LI					153		160		163	166						
	SINGLES		3740	5360	6400	7150	8050	9100	9900	10500	10700	11700						
	DUALS		3290	4720	5630	6290	7080	8010	8710	9240	9420	10300						
	TRIPLES		3070	4400	5250	5860	6600	7460	8120	8610	8770	9590						
AD ₂ IF480/85R34		LI				145	149		155		158							
	SINGLES		3960	4680	5520	6400	7150	7850	8550	9100	9350							
	DUALS		3480	4120	4860	5630	6290	6910	7520	8010	8230							
	TRIPLES		3250	3840	4530	5250	5860	6440	7010	7460	7670							
AD ₂ IF480/95R50		LI					158		165									
	SINGLES		4300	6150	7150	8250	9350	10500	11400									
	DUALS		3780	5410	6290	7260	8230	9240	10030									
	TRIPLES		3530	5040	5860	6770	7670	8610	9350									
AD ₂ IF520/85R34		LI				149	153		160		163	165	168					
	SINGLES		4400	5360	6150	7150	8050	8800	9900	10200	10700	11400	12300					
	DUALS		3870	4720	5410	6290	7080	7740	8710	8980	9420	10030	10820					
	TRIPLES		3610	4400	5040	5860	6600	7220	8120	8360	8770	9350	10090					
AD ₂ IF520/85R42		LI				152	156		163		166	169						
	SINGLES		4940	5840	6950	7850	8800	9900	10700	11400	11700	12800						
	DUALS		4350	5140	6120	6910	7740	8710	9420	10030	10300	11260						
	TRIPLES		4050	4790	5700	6440	7220	8120	8770	9350	9590	10500						
AD ₂ IF520/85R46		LI					157		165									
	SINGLES		4300	6150	7150	8250	9100	10200	11400									
	DUALS		3780	5410	6290	7260	8010	8980	10030									
	TRIPLES		3530	5040	5860	6770	7460	8360	9350									
AD ₂ IF580/80R34		LI				153	157		164		167	169	172					
	SINGLES		4940	6000	6950	8050	9100	9900	11000	11700	12000	12800	13900					
	DUALS		4350	5280	6120	7080	8010	8710	9680	10300	10560	11260	12230					
	TRIPLES		4050	4920	5700	6600	7460	8120	9020	9590	9840	10500	11400					
AD ₂ IF580/85R42		LI				158	162		169		172	174	178					
	SINGLES		5840	6950	8050	9350	10500	11700	12800	13600	13900	14800	16500					
	DUALS		5140	6100	7100	8250	9250	10300	11300	12000	12200	13000	14500					
	TRIPLES		4780	5700	6600	7650	8600	9600	10500	11200	11400	12100	13500					
AD ₂ IF600/70R30		LI					153		159									
	SINGLES		3640	5360	6150	7150	8050	8800	9650									
	DUALS		3200	4720	5410	6290	7080	7740	8490									
	TRIPLES		2980	4400	5040	5860	6600	7220	7910									
AD ₂ IF620/75R30		LI					156		164		167	169						
	SINGLES		4180	6000	6950	8050	8800	9900	11000	11400	12000	12800						
	DUALS		3680	5280	6120	7080	7740	8710	9680	10030	10560	11260						
	TRIPLES		3430	4920	5700	6600	7220	8120	9020	9350	9840	10500						

FOR RIM AND WHEEL LOAD INFORMATION, SEE IMPORTANT NOTES ON PAGES 168-172.

RADIAL FARM

BIAS FARM

FRONTS & IMPLEMENTS

FORESTRY & FLOTATION

DISCONTINUED

LOAD & INFLATION TABLES

GENERAL TIRE INFORMATION

WARRANTY

TABLE C – AD₂ IF LOAD DESIGNATION FOR RADIAL AGRICULTURAL DRIVE WHEEL TIRES

BASIC TIRE LOAD RATINGS FOR TIRE SELECTION METRIC UNITS OF MEASURE (kg@kPa)

TIRE SIZE	INFLATION			LOAD LIMITS AT VARIOUS COLD INFLATION PRESSURES														
	kPa	40	60	80	100	120	140	160	180	200	240	280	320	360	400	440	480	
	bar	0.4	0.6	0.8	1.0	1.2	1.4	1.6	1.8	2.0	2.4	2.8	3.2	3.6	4.0	4.4	4.8	
LOAD LIMITS IN KG., INFLATION PRESSURE IN kPa																		
AD ₂ IF480/80R46		LI				148	152		158		162	164						
	SINGLES		1950	2360	2730	3160	3560	3880	4260	4500	4760	5000						
	DUALS		1720	2080	2400	2770	3120	3420	3740	3960	4180	4400						
	TRIPLES		1600	1940	2230	2580	2910	3180	3480	3700	3900	4100						
AD ₂ IF480/80R50		LI					153		160		163	166						
	SINGLES		1700	2430	2900	3250	3650	4125	4500	4750	4875	5300						
	DUALS		1500	2140	2550	2860	3210	3630	3960	4180	4290	4660						
	TRIPLES		1390	1990	2380	2670	2990	3380	3690	3900	4000	4350						
AD ₂ IF480/85R34		LI				145	149		155		158							
	SINGLES		1800	2120	2500	2900	3250	3550	3875	4125	4250							
	DUALS		1580	1870	2200	2550	2860	3120	3410	3630	3740							
	TRIPLES		1480	1740	2050	2380	2670	2910	3180	3380	3490							
AD ₂ IF480/95R50		LI					158		165									
	SINGLES		1950	2800	3250	3750	4250	4750	5150									
	DUALS		1720	2460	2860	3300	3740	4180	4530									
	TRIPLES		1600	2300	2670	3080	3490	3900	4220									
AD ₂ IF520/85R34		LI				149	153		160		163	165	168					
	SINGLES		2000	2430	2800	3250	3650	4000	4500	4625	4875	5150	5600					
	DUALS		1760	2140	2460	2860	3210	3520	3960	4070	4290	4530	4930					
	TRIPLES		1640	1990	2300	2670	2990	3280	3690	3790	4000	4220	4590					
AD ₂ IF520/85R42		LI				152	156		163		166	169						
	SINGLES		2240	2650	3150	3550	4000	4500	4875	5150	5300	5800						
	DUALS		1970	2330	2770	3120	3520	3960	4290	4530	4660	5100						
	TRIPLES		1840	2170	2580	2910	3280	3690	4000	4220	4350	4760						
AD ₂ IF520/85R46		LI					157		165									
	SINGLES		1950	2800	3250	3750	4125	4625	5150									
	DUALS		1720	2460	2860	3300	3630	4070	4530									
	TRIPLES		1600	2300	2670	3080	3380	3790	4220									
AD ₂ IF580/80R34		LI				153	157		164		167	169	172					
	SINGLES		2240	2725	3150	3650	4125	4500	5000	5300	5450	5800	6300					
	DUALS		1970	2400	2770	3210	3630	3960	4400	4660	4800	5100	5540					
	TRIPLES		1840	2230	2580	2990	3380	3690	4100	4350	4470	4760	5170					
AD ₂ IF580/85R42		LI				158	162		169		172	174	178					
	SINGLES		2650	3160	3660	4260	4760	5300	5800	6150	6300	6700	7500					
	DUALS		2330	2770	3220	3740	4180	4660	5100	5420	5540	5900	6600					
	TRIPLES		2170	2580	2990	3480	3900	4340	4760	5040	5160	5500	6150					
AD ₂ IF600/70R30		LI					153		159									
	SINGLES		1650	2430	2800	3250	3650	4000	4375									
	DUALS		1450	2140	2460	2860	3210	3520	3850									
	TRIPLES		1350	1990	2300	2670	2990	3280	3590									
AD ₂ IF620/75R30		LI					156		164		167	169						
	SINGLES		1900	2725	3150	3650	4000	4500	5000	5150	5450	5800						
	DUALS		1670	2400	2770	3210	3520	3960	4400	4530	4800	5100						
	TRIPLES		1560	2230	2580	2990	3280	3690	4100	4220	4470	4760						

FOR RIM AND WHEEL LOAD INFORMATION, SEE IMPORTANT NOTES ON PAGES 168-172.

TABLE C – AD₂ IF LOAD DESIGNATION FOR RADIAL AGRICULTURAL DRIVE WHEEL TIRES

BASIC TIRE LOAD RATINGS FOR TIRE SELECTION

ENGLISH UNITS OF MEASURE (lbs@psi)

TIRE SIZE	INFLATION psi Symbol	LOAD LIMITS AT VARIOUS COLD INFLATION PRESSURES															
		6	9	12	15	17	20	23	26	29	35	41	46	52	58	64	70
		LOAD LIMITS IN LBS., INFLATION PRESSURE IN PSI															
AD ₂ IF650/85R38	LI					167	174		177	179							
	SINGLES	5520	8050	9350	10700	12000	13200	14800	15200	16100	17100						
	DUALS	4860	7080	8230	9420	10560	11620	13020	13380	14170	15050						
	TRIPLES	4530	6600	7670	8770	9840	10820	12140	12460	13200	14020						
AD ₂ IF710/70R38	LI					165	172		175	178							
	SINGLES	5360	7600	8800	10200	11400	12800	13900	14800	15200	16500						
	DUALS	4720	6690	7740	8980	10030	11260	12230	13020	13380	14520						
	TRIPLES	4400	6230	7220	8360	9350	10500	11400	12140	12460	13530						
AD ₂ IF710/70R42	LI					167	174		177	179							
	SINGLES	5520	8050	9350	10700	12000	13200	14800	15700	16100	17100						
	DUALS	4860	7080	8230	9420	10560	11620	13020	13820	14170	15050						
	TRIPLES	4530	6600	7670	8770	9840	10820	12140	12870	13200	14020						
AD ₂ IF710/75R42	LI					169	176		179	181							
	SINGLES	5840	8550	9900	11400	12800	14300	15700	16500	17100	18200						
	DUALS	5140	7520	8710	10030	11260	12580	13820	14520	15050	16020						
	TRIPLES	4790	7010	8120	9350	10500	11730	12870	13530	14020	14920						
AD ₂ IF800/60R32	LI				158	162		169	173	176	179	181					
	SINGLES	5840	6950	8250	9350	10500	11700	12800	13600	14300	15700	17100	18200				
	DUALS	5140	6120	7260	8230	9240	10300	11260	11970	12580	13820	15000	16020				
	TRIPLES	4790	5700	6770	7670	8610	9590	10500	11150	11730	12870	14000	14920				
AD ₂ IF800/70R38	LI					172		179		182	184						
	SINGLES	6400	9350	10700	12300	13900	15200	17100	17600	18700	19800						
	DUALS	5630	8230	9420	10820	12230	13380	15050	15490	16460	17420						
	TRIPLES	5250	7670	8770	10090	11400	12460	14020	14430	15330	16240						
AD ₂ IF850/75R42	LI					179		186									
	SINGLES	7850	11400	13200	15200	17100	18700	20900									
	DUALS	6910	10030	11620	13380	15050	16460	18390									
	TRIPLES	6440	9350	10820	12460	14020	15330	17140									
AD ₂ IF900/60R32	LI				165	169		176		179	182	185	188				
	SINGLES	7150	8550	9900	11400	12800	14300	15700	16500	17100	18700	20400	22000				
	DUALS	6300	7500	8700	10000	11300	12600	13800	14500	15000	16500	18000	19400				
	TRIPLES	5860	7000	8100	9350	10500	11700	12900	13500	14000	15300	16700	18000				
AD ₂ IF900/65R32	LI				169	173		178		182	185	188	191				
	SINGLES	7850	9350	11000	12800	14300	15700	16500	17600	18700	20400	22000	24000				
	DUALS	6900	8250	9700	11300	12600	13800	14500	15500	16500	18000	19400	21100				
	TRIPLES	6450	7650	9000	10500	11700	12900	13500	14400	15300	16700	18000	19700				
AD ₂ IF900/75R32	LI				174	178											
	SINGLES	9350	11000	12800	14800	16500											
	DUALS	8250	9700	11300	13000	14500											
	TRIPLES	7650	9000	10500	12100	13500											
AD ₂ IF1100/50R42	LI					178		185		189	191	195	197				
	SINGLES			12800	14800	16500	18200	20400	21500	22700	24000	26800	28300				
	DUALS			11260	13020	14520	16020	17950	18920	19980	22350	23580	24900				
	TRIPLES			10500	12140	13530	14920	16730	17630	18610	20830	21980	23210				

FOR RIM AND WHEEL LOAD INFORMATION, SEE IMPORTANT NOTES ON PAGES 168-172.

RADIAL FARM

BIAS FARM

FRONTS & IMPLEMENTS

FORESTRY & FLOTATION

DISCONTINUED

LOAD & INFLATION TABLES

GENERAL TIRE INFORMATION

WARRANTY

TABLE C – AD₂ IF LOAD DESIGNATION FOR RADIAL AGRICULTURAL DRIVE WHEEL TIRES

BASIC TIRE LOAD RATINGS FOR TIRE SELECTION

METRIC UNITS OF MEASURE (kg@kPa)

TIRE SIZE	INFLATION		LOAD LIMITS AT VARIOUS COLD INFLATION PRESSURES															
	kPa		40	60	80	100	120	140	160	180	200	240	280	320	360	400	440	480
	bar		0.4	0.6	0.8	1.0	1.2	1.4	1.6	1.8	2.0	2.4	2.8	3.2	3.6	4.0	4.4	4.8
LOAD LIMITS IN KG., INFLATION PRESSURE IN kPa																		
		LI				167	174		177	179								
AD ₂ IF650/85R38	SINGLES		2500	3650	4250	4875	5450	6000	6700	6900	7300	7750						
	DUALS		2200	3210	3740	4290	4800	5280	5900	6070	6420	6820						
	TRIPLES		2050	2990	3490	4000	4470	4920	5490	5660	5990	6360						
AD ₂ IF710/70R38	SINGLES		2430	3450	4000	4625	5150	5800	6300	6700	6900	7500						
	DUALS		2140	3040	3520	4070	4530	5100	5540	5900	6070	6600						
	TRIPLES		1990	2830	3280	3790	4220	4760	5170	5490	5660	6150						
AD ₂ IF710/70R42	SINGLES		2500	3650	4250	4875	5450	6000	6700	7100	7300	7750						
	DUALS		2200	3210	3740	4290	4800	5280	5900	6250	6420	6820						
	TRIPLES		2050	2990	3490	4000	4470	4920	5490	5820	5990	6360						
AD ₂ IF710/75R42	SINGLES		2650	3875	4500	5150	5800	6500	7100	7500	7750	8250						
	DUALS		2330	3410	3960	4530	5100	5720	6250	6600	6820	7260						
	TRIPLES		2170	3180	3690	4220	4760	5330	5820	6150	6360	6770						
AD ₂ IF800/60R32	SINGLES		2650	3150	3750	4250	4750	5300	5800	6150	6500	7100	7750	8250				
	DUALS		2330	2770	3300	3740	4180	4660	5100	5410	5720	6250	6820	7260				
	TRIPLES		2170	2580	3080	3490	3900	4350	4760	5040	5330	5820	6360	6770				
AD ₂ IF800/70R38	SINGLES		2900	4250	4875	5600	6300	6900	7750	8000	8500	9000						
	DUALS		2550	3740	4290	4930	5540	6070	6820	7040	7480	7920						
	TRIPLES		2380	3490	4000	4590	5170	5660	6360	6560	6970	7380						
AD ₂ IF850/75R42	SINGLES		3550	5150	6000	6900	7750	8500	9500									
	DUALS		3120	4530	5280	6070	6820	7480	8360									
	TRIPLES		2910	4220	4920	5660	6360	6970	7790									
AD ₂ IF900/60R32	SINGLES		3260	3880	4500	5160	5800	6500	7100	7500	7750	8500	9250	10000				
	DUALS		2860	3420	3960	4540	5100	5720	6250	6600	6800	7500	8150	8800				
	TRIPLES		2670	3180	3700	4220	4760	5340	5820	6150	6350	6950	7600	8200				
AD ₂ IF900/65R32	SINGLES		3560	4260	5000	5800	6500	7100	7500	8000	8500	9250	####	10900				
	DUALS		3120	3740	4400	5100	5720	6250	6600	7050	7500	8150	8800	9600				
	TRIPLES		2910	3480	4100	4760	5340	5820	6150	6550	6950	7600	8200	8950				
AD ₂ IF900/75R32	SINGLES		4260	5000	5800	6700	7500											
	DUALS		3740	4400	5100	5900	6600											
	TRIPLES		3480	4100	4760	5500	6150											
AD ₂ IF1100/50R42	SINGLES				5800	6700	7500	8250	9250	9750	10300	10900	12150	12850				
	DUALS				5100	5900	6600	7260	8140	8580	9060	9590	10690	11310				
	TRIPLES				4760	5490	6150	6770	7590	8000	8450	8940	9960	10540				

FOR RIM AND WHEEL LOAD INFORMATION, SEE IMPORTANT NOTES ON PAGES 168-172.

TABLE C — AD₂ IF LOAD DESIGNATION FOR RADIAL AGRICULTURAL DRIVE WHEEL TIRES

BASIC TIRE LOAD RATINGS FOR TIRE SELECTION

ENGLISH UNITS OF MEASURE (lbs@psi)

TIRE SIZE	INFLATION		LOAD LIMITS AT VARIOUS COLD INFLATION PRESSURES															
	psi	Symbol	6	9	12	15	17	20	23	26	29	35	41	46	52	58	64	70
LOAD LIMITS IN LBS., INFLATION PRESSURE IN PSI																		
AD ₂ IF1250/50R32		LI				177	181		188		192	195	198	201				
	SINGLES		10200	12000	14300	16100	18200	20400	22000	23400	24700	26800	29100	32000				
	DUALS		5980	10560	12580	14170	16020	17950	19360	20590	21740	23580	25610	28160				
	TRIPLES		8360	9840	11730	13200	14920	16730	18040	19190	20250	21980	23860	26240				

RADIAL FARM

BIAS FARM

FRONTS &
IMPLEMENTS

FORESTRY &
FLOTATION

DISCONTINUED

LOAD & INFLATION
TABLES

GENERAL TIRE
INFORMATION

WARRANTY

FOR RIM AND WHEEL LOAD INFORMATION, SEE IMPORTANT NOTES ON PAGES 168-172.

TABLE C – AD₂ IF LOAD DESIGNATION FOR RADIAL AGRICULTURAL DRIVE WHEEL TIRES

BASIC TIRE LOAD RATINGS FOR TIRE SELECTION

METRIC UNITS OF MEASURE (kg@kPa)

TIRE SIZE	INFLATION		LOAD LIMITS AT VARIOUS COLD INFLATION PRESSURES															
	kPa		40	60	80	100	120	140	160	180	200	240	280	320	360	400	440	480
	bar		0.4	0.6	0.8	1.0	1.2	1.4	1.6	1.8	2.0	2.4	2.8	3.2	3.6	4.0	4.4	4.8
LOAD LIMITS IN KG., INFLATION PRESSURE IN kPa																		
	LI			177		181		188		192	195	198	201					
AD ₂ IF1250/50R32	SINGLES		4625	5450	6500	7300	8250	9250	10000	10600	11200	12150	13200	14500				
	DUALS		4070	4800	5720	6420	7260	8140	8800	9330	9860	10690	11620	12760				
	TRIPLES		3790	4470	5330	5990	6770	7590	8200	8690	9180	9960	10820	11890				

- RADIAL FARM
- BIAS FARM
- FRONTS & IMPLEMENTS
- FORESTRY & FLOTATION
- DISCONTINUED
- LOAD & INFLATION TABLES
- GENERAL TIRE INFORMATION
- WARRANTY

FOR RIM AND WHEEL LOAD INFORMATION, SEE IMPORTANT NOTES ON PAGES 168-172.



TABLE C2 – AD₂ VF LOAD DESIGNATION FOR RADIAL AGRICULTURAL DRIVE WHEEL TIRES

TIRE TYPE NOMENCLATURE		MAX SPEED	
TRA	TIRE TYPE	A/B	D
R-1	Drive Wheel, Regular Tread	30 mph	40 mph
R-1W	Drive Wheel, Wet Traction Tread	30 mph	40 mph
R-2	Cane & Rice, Drive Wheel, Deep Tread	30 mph	—

BASIC TIRE LOAD RATINGS FOR TIRE SELECTION ENGLISH UNITS OF MEASURE (lbs@psi)

TIRE SIZE	INFLATION	psi Symbol	LOAD LIMITS AT VARIOUS COLD INFLATION PRESSURES															
			6	9	12	15	17	20	23	26	29	35	41	46	52	58	64	70
			LOAD LIMITS IN LBS., INFLATION PRESSURE IN PSI															
AD ₂ VF380/80R38	SINGLES	LI	3			138	142		149		152	154						
	DUALS		3200	3860	4540	5200	5840	6400	7150	7400	7850	8250						
	TRIPLES		2820	3400	4000	4580	5140	5630	6290	6510	6910	7260						
AD ₂ VF380/95R38	SINGLES	LI					146		154									
	DUALS		3740	4400	5200	6000	6600	7400	8250									
	TRIPLES		3290	3870	4580	5280	5810	6510	7260									
AD ₂ VF380/90R46	SINGLES	LI				144	148		155		158	161	164	167	169	170	173	
	DUALS		3860	4680	5520	6150	6950	7850	8550	9100	9350	10200	11000	12000	12800	13200	14300	
	TRIPLES		3400	4120	4860	5410	6120	6910	7520	8010	8230	8980	9680	10560	11300	11620	12580	
AD ₂ VF380/90R50	SINGLES	LI				146	150		157		160	162	165	168	170	172	175	178
	DUALS		4080	4940	5680	6600	7400	8250	9100	9350	9900	10500	11400	12300	13200	13900	15200	16500
	TRIPLES		3600	4340	5000	5800	6500	7250	8000	8250	8700	9250	10000	10800	11600	12200	13400	14500
AD ₂ VF380/90R54	SINGLES	LI				147	151		158		161	164	167	169	172	173	176	179
	DUALS		4300	5080	6000	6800	7600	8550	9350	9900	10200	11000	12000	12800	13900	14300	15700	17100
	TRIPLES		3780	4480	5280	5980	6700	7500	8250	8700	9000	9700	10600	11300	12200	12600	13800	15000
AD ₂ VF380/105R50	SINGLES	LI				150	154		161		165	167	170	172	175	176	179	
	DUALS		3520	4160	4920	5580	6250	7000	7650	8100	8350	9000	9850	10500	11400	11700	12900	14000
	TRIPLES		4680	5520	6400	7400	8250	9350	10200	10700	11400	12000	13200	13900	15200	15700	17100	
AD ₂ VF420/85R34	SINGLES	LI				143	147				157							
	DUALS		3740	4540	5200	6000	6800	7400	8250	8550	9100							
	TRIPLES		3290	4000	4580	5280	5980	6510	7260	7520	8010							
AD ₂ VF420/85R38	SINGLES	LI				145	149		155		159							
	DUALS		3070	3720	4260	4920	5580	6070	6770	7010	7460							
	TRIPLES		3960	4680	5520	6400	7150	7850	8550	9100	9650							
AD ₂ VF480/80R46	SINGLES	LI					157		164		167	169						
	DUALS		4170	4920	5700	6600	7460	8360	9020	9590	9840	10500						
	TRIPLES		5080	6000	6950	8050	9100	10200	11000	11700	12000	12800						

FOR RIM AND WHEEL LOAD INFORMATION, SEE IMPORTANT NOTES ON PAGES 168-172.

RADIAL FARM
 BIAS FARM
 FRONTS & IMPLEMENTS
 FORESTRY & FLOTATION
 DISCONTINUED
 LOAD & INFLATION TABLES
 GENERAL TIRE INFORMATION
 WARRANTY

TABLE C2 – AD2 VF LOAD DESIGNATION FOR RADIAL AGRICULTURAL DRIVE WHEEL TIRES

TRA	TIRE TYPE	SPEED INDEX	
		A8/B	D
R-1	Drive Wheel, Regular Tread	50 km/h	65 km/h
R-1W	Drive Wheel, Wet Traction Tread	50 km/h	65 km/h
R-2	Cane & Rice, Drive Wheel, Deep Tread	50 km/h	—

BASIC TIRE LOAD RATINGS FOR TIRE SELECTION METRIC UNITS OF MEASURE (kg@kPa)

TIRE SIZE		INFLATION																
		0.4																
		kPa	40	60	80	100	120	140	160	180	200	240	280	320	360	400	440	480
bar	0.4	0.6	0.8	1.0	1.2	1.4	1.6	1.8	2.0	2.4	2.8	3.2	3.6	4.0	4.4	4.8		
AD2 VF380/80R38		LI				138	142		149		152	154						
	SINGLES		1450	1750	2060	2360	2650	2900	3250	3350	3350	8250						
	DUALS		1280	1540	1810	2080	2330	2550	2860	2950	2950	7260						
	TRIPLES		1190	1440	1690	1940	2170	2380	2670	2750	2750	6770						
AD2 VF380/95R38		LI				143	146		154									
	SINGLES		1700	2000	2360	2725	3000	3350	3750									
	DUALS		1500	1760	2080	2400	2640	2950	3300									
	TRIPLES		1390	1640	1940	2240	2460	2750	3080									
AD2 VF380/90R46		LI				144	148		155		158	161	164	167	169	170	173	
	SINGLES		1750	2120	2500	2800	3150	3550	3875	4125	4250	4625	5000	5450	5800	6000	6500	
	DUALS		1540	1870	2200	2460	2770	3120	3420	3640	3740	4080	4400	4800	5100	5280	5720	
	TRIPLES		1440	1740	2050	2300	2580	2910	3180	3380	3480	3800	4100	4460	4760	4920	5340	
AD2 VF380/90R50		LI				146	150		157		160	162	165	168	170	172	175	178
	SINGLES		4080	4940	5680	6600	7400	8250	9100	9350	9900	10500	11400	12300	13200	13900	15200	16500
	DUALS		3600	4340	5000	5800	6500	7250	8000	8250	8700	9250	10000	10800	11600	12200	13400	14500
	TRIPLES		3340	4060	4660	5420	6050	6750	7450	7650	8100	8600	9350	10100	10800	11400	12500	13500
AD2 VF380/90R54		LI				147	151		158		161	164	167	169	172	173	176	179
	SINGLES		4300	5080	6000	6800	7600	8550	9350	9900	10200	11000	12000	12800	13900	14300	15700	17100
	DUALS		3780	4480	5280	5980	6700	7500	8250	8700	9000	9700	10600	11300	12200	12600	13800	15000
	TRIPLES		3520	4160	4920	5580	6250	7000	7650	8100	8350	9000	9850	10500	11400	11700	12900	14000
AD2 VF380/105R50		LI				150	154		161		165	167	170	172	175	176	179	
	SINGLES		2120	2500	2900	3350	3750	4250	4625	4875	5150	5450	6000	6300	6900	7100	7750	
	DUALS		1870	2200	2550	2950	3300	3740	4080	4300	4540	4800	5280	5540	6050	6250	6800	
	TRIPLES		1740	2050	2380	2750	3080	3480	3800	4000	4220	4460	4920	5160	5660	5820	6350	
AD2 VF420/85R34		LI				143	147				157							
	SINGLES		1700	2060	2360	2730	3080	3350	3750	3880	4130							
	DUALS		1500	1810	2080	2400	2710	2950	3300	3410	3630							
	TRIPLES		1390	1690	1940	2240	2520	2750	3080	3180	3390							
AD2 VF420/85R38		LI				145	149		155		159							
	SINGLES		1800	2120	2500	2900	3250	3550	3880	4130	4380							
	DUALS		1580	1870	2200	2550	2860	3120	3410	3630	3850							
	TRIPLES		1480	1740	2050	2380	2670	2910	3180	3390	3590							
AD2 VF480/80R46		LI					157		164		167	169						
	SINGLES		2300	2730	3150	3650	4130	4630	5000	5300	5450	5800						
	DUALS		2020	2400	2770	3210	3634	4074	4400	4660	4800	5100						
	TRIPLES		1890	2240	2580	2990	3390	3800	4100	4350	4470	4760						

FOR RIM AND WHEEL LOAD INFORMATION, SEE IMPORTANT NOTES ON PAGES 168-172.

TABLE C2 — AD₂ VF LOAD DESIGNATION FOR RADIAL AGRICULTURAL DRIVE WHEEL TIRES

BASIC TIRE LOAD RATINGS FOR TIRE SELECTION

ENGLISH UNITS OF MEASURE (lbs@psi)

TIRE SIZE	INFLATION		LOAD LIMITS AT VARIOUS COLD INFLATION PRESSURES															
	psi	Symbol	6	9	12	15	17	20	23	26	29	35	41	46	52	58	64	70
	LOAD LIMITS IN LBS., INFLATION PRESSURE IN PSI																	
AD ₂ VF480/80R50		LI					158		166		169	171						
	SINGLES		5200	6400	7400	8250	9350	10500	11700	12000	12800	13600						
	DUALS		4580	5630	6510	7260	8230	9240	10300	10560	11260	11970						
	TRIPLES		4260	5250	6070	6770	7670	8610	9590	9840	10500	11150						
AD ₂ VF480/95R50		LI					164		170									
	SINGLES		6000	7150	8550	9650	11000	12000	13200									
	DUALS		5280	6290	7520	8490	9680	10560	11620									
	TRIPLES		4920	5860	7010	7010	9020	9840	10820									
AD ₂ VF520/85R46		LI					163		170									
	SINGLES		6000	7150	8250	9650	10700	12000	13200									
	DUALS		5280	6290	7260	8490	9420	10560	11620									
	TRIPLES		4920	5860	6770	7910	8770	9840	10820									
AD ₂ VF580/85R42		LI				163	167		174		178	180	183					
	SINGLES		6800	8050	9350	10700	12000	13600	14800	15700	16500	17600	19300					
	DUALS		5980	7080	8230	9420	10560	11970	13020	13820	14520	15490	16980					
	TRIPLES		5580	6600	7670	8770	9840	11150	12140	12870	13530	14430	15830					
AD ₂ VF600/70R28		LI				153	157		164		167	169	173					
	SINGLES		5080	6000	6950	8050	9100	9900	11000	11700	12000	12800	14300					
	DUALS		4480	5280	6100	7100	8000	8700	9700	10300	10600	11300	12600					
	TRIPLES		4160	4920	5700	6600	7450	8100	9000	9600	9850	10500	11700					
AD ₂ VF620/70R46		LI					167		173		177		179					
	SINGLES		6600	7850	9350	10500	12000	13200	14300	15200	16100	16500	17100					
	DUALS		5810	6910	8230	9240	10560	11620	12580	13380	14170	14520	15050					
	TRIPLES		5410	6440	7670	8610	9840	10820	11730	12460	13200	13530	14020					
AD ₂ VF620/75R26		LI				156	160		167		170	172						
	SINGLES		5520	6600	7600	8800	9900	11000	12000	12800	13200	13900						
	DUALS		4860	5800	6700	7750	8700	9700	10600	11300	11600	12200						
	TRIPLES		4520	5420	6250	7200	8100	9000	9850	10500	10800	11400						
AD ₂ VF650/60R34		LI					157		165		168							
	SINGLES		5080	6150	7150	8050	9100	10200	11400	11700	12300							
	DUALS		4470	5410	6290	7080	8010	8980	10030	10300	10820							
	TRIPLES		4170	5040	5860	6600	7460	8360	9350	9590	10090							
AD ₂ VF750/65R26		LI				161	165		171		174	177						
	SINGLES		6400	7600	8800	10200	11400	12300	13600	14300	14800	16100						
	DUALS		5630	6690	7740	8980	10030	10820	11970	12580	13020	14170						
	TRIPLES		5250	6230	7220	8360	9350	10090	11150	11730	12140	13200						
AD ₂ VF800/70R38		LI					177		184		187	190	193					
	SINGLES		9100	10700	12800	14300	16100	18200	19800	20900	21500	23400	25400					
	DUALS		8010	9420	11260	12580	14170	16020	17420	18390	18920	20590	22350					
	TRIPLES		7460	8770	10500	11730	13200	14920	16240	17140	17630	19190	20830					
AD ₂ VF900/60R42		LI				174	178		185		189							
	SINGLES		9350	11000	12800	14800	16500	18700	20400	21500	22700							
	DUALS		8250	9700	11300	13000	14500	16500	18000	18900	20000							
	TRIPLES		7650	9000	10500	12100	13500	15300	16700	17600	18600							

FOR RIM AND WHEEL LOAD INFORMATION, SEE IMPORTANT NOTES ON PAGES 168-172.

RADIAL FARM

BIAS FARM

FRONTS & IMPLEMENTS

FORESTRY & FLOTATION

DISCONTINUED

LOAD & INFLATION TABLES

GENERAL TIRE INFORMATION

WARRANTY

TABLE C2 – AD2 VF LOAD DESIGNATION FOR RADIAL AGRICULTURAL DRIVE WHEEL TIRES

BASIC TIRE LOAD RATINGS FOR TIRE SELECTION

METRIC UNITS OF MEASURE (kg@kPa)

TIRE SIZE		INFLATION															
		kPa	0.4														
			40	60	80	100	120	140	160	180	200	240	280	320	360	400	440
bar	0.4	0.6	0.8	1.0	1.2	1.4	1.6	1.8	2.0	2.4	2.8	3.2	3.6	4.0	4.4	4.8	
AD2 VF480/80R50		LI					158		166		169	171					
	SINGLES		2360	2900	3350	3750	4250	4750	5300	5450	5800	6150					
	DUALS		2080	2550	2950	3300	3740	4180	4660	4800	5100	5410					
	TRIPLES		1940	2380	2750	3080	3490	3900	4350	4470	4760	5040					
AD2 VF480/95R50		LI					164		170								
	SINGLES		2730	3250	3880	4380	5000	5450	6000								
	DUALS		2400	2860	3410	3850	4400	4800	5280								
	TRIPLES		2240	2670	3180	3590	4100	4470	4920								
AD2 VF520/85R46		LI															
	SINGLES		2730	3250	3750	4375	4875	5450	6000								
	DUALS		2400	2860	3300	3850	4290	4800	5280								
	TRIPLES		2240	2670	3080	3590	4000	4470	4920								
AD2 VF580/85R42		LI				163	167		174		178	180	183				
	SINGLES		3080	3660	4260	4880	5460	6150	6700	7100	7500	8000	8750				
	DUALS		2710	3220	3750	4290	4810	5410	5900	6250	6600	7040	7700				
	TRIPLES		2530	3000	3490	4000	4480	5040	5490	5820	6150	6560	7180				
AD2 VF600/70R28		LI				153	157		164		167	169	173				
	SINGLES		2300	2730	3160	3660	4120	4500	5000	5300	5460	5800	6500				
	DUALS		2020	2400	2770	3220	3640	3960	4400	4660	4800	5100	5720				
	TRIPLES		1890	2230	2580	2990	3380	3700	4100	4340	4460	4760	5340				
AD2 VF620/70R46		LI				167		173		177		179					
	SINGLES		3000	3550	4250	4750	5450	6000	6500	6900	7300	7500	7750				
	DUALS			3120	3740	4180	4800	5280	5720	6070	6420	6600	6820				
	TRIPLES			2910	3490	3900	4470	4920	5330	5660	5990	6150	6360				
AD2 VF620/75R26		LI				156	160		167		170	172					
	SINGLES		2500	3000	3460	4000	4500	5000	5460	5800	6000	6300					
	DUALS		2200	2640	3040	3520	3960	4400	4800	5100	5280	5540					
	TRIPLES		2050	2460	2830	3280	3700	4100	4460	4760	4920	5160					
AD2 VF650/60R34		LI				157		165		168							
	SINGLES		2300	2800	3250	3650	4130	4630	5150	5300	5600						
	DUALS		2020	2460	2860	3210	3630	4074	4530	4660	4930						
	TRIPLES		1890	2300	2670	2990	3390	3800	4220	4350	4590						
AD2 VF750/65R26		LI				161	165		171		174	177					
	SINGLES		2900	3450	4000	4625	5150	5600	6150	6500	6700	7300					
	DUALS		2550	3040	3520	4070	4530	4930	5410	5720	5900	6420					
	TRIPLES		2380	2830	3280	3790	4220	4590	5040	5330	5490	5990					
AD2 VF800/70R38		LI				173	177		184		187	190	193				
	SINGLES			4130	4880	5800	7300	8250	9000	9500	9750	10600	11500				
	DUALS			3630	4300	5100	6420	7260	7920	8360	8580	9339	10120				
	TRIPLES			3390	4000	4760	5990	6770	7380	7790	8000	8690	9430				
AD2 VF900/60R42		LI				174	178		185		189						
	SINGLES		4250	5000	5800	6700	7500	8500	9250	9750	10300						
	DUALS		3740	4400	5100	5900	6600	7480	8140	8580	9060						
	TRIPLES		3490	4100	4760	5490	6150	6970	7590	8000	8450						

FOR RIM AND WHEEL LOAD INFORMATION, SEE IMPORTANT NOTES ON PAGES 168-172.

TABLE C3 – AD₂ IF AND VF LOAD FOR RADIAL IMPLEMENT TIRES

TIRE TYPE NOMENCLATURE		MAX SPEED
TRA	TIRE TYPE	SPEED INDEX
I-1	Rib Tread	D-40 mph

BASIC TIRE LOAD RATINGS FOR TIRE SELECTION

TIRE SIZE	psi kPa	LOAD LIMITS AT VARIOUS COLD INFLATION PRESSURES																		
		17	20	23	26	29	32	35	38	41	44	46	49	52	55	58	61	64	67	70
		120	140	160	180	200	220	240	260	280	300	320	340	360	380	400	420	440	460	480
AD ₂ IF200/90R15	LI	90		97		103		107		111		114								
	lbs	1320	1480	1610	1760	1930	2040	2150	2270	2400	2600	2600								
	kg	600	670	730	800	875	925	975	1030	1090	1180	1180								
AD ₂ IF210/75R15	LI	88		94		100		104		109		111		115						
	lbs	1230	1360	1480	1610	1760	1930	1980	2090	2270	2400	2400	2540	2680						
	kg	560	615	670	730	800	875	900	950	1030	1090	1090	1150	1215						
AD ₂ IF240/80R15	LI			103		109		113		118		121								
	lbs			1930	2090	2270	2470	2540	2760	2910	3080	3200								
	kg			875	950	1030	1120	1150	1250	1320	1400	1450								
AD ₂ IF265/85R15	LI	103		111		117		121		125										
	lbs	1930	2150	2400	2600	2830	3000	3200	3420	3640										
	kg	875	975	1090	1180	1285	1360	1450	1550	1650										
AD ₂ IF280/70R15	LI					114		118		122		124		128				134		
	lbs				2400	2600	2760	2910	3080	3300	3520	3520	3740	3960	4080	4540	4680			
	kg				1090	1180	1250	1320	1400	1500	1600	1600	1700	1800	1850	2060	2120			
AD ₂ IF320/65R15	LI	105		113		119		122		126		129		133			139		142	
	lbs	2040	2270	2540	2760	3000	3200	3300	3520	3740	3960	4080	4300	4540	4800	5200	5360	5680	5840	
	kg	925	1030	1150	1250	1360	1450	1500	1600	1700	1800	1850	1950	2060	2180	2360	2430	2575	2650	
AD ₂ IF320/70R15	LI	108		115		121		124		129		132		135			142		144	
	lbs	2200	2470	2680	2910	3200	3420	3520	3860	4080	4300	4400	4680	4800	5080	5520	5840	6000	6150	
	kg	1000	1120	1215	1320	1450	1550	1600	1750	1850	1950	2000	2120	2180	2300	2500	2650	2725	2800	

NOTES:

1. There are no adjustments to the loads and pressures in the above tables for lower transport speeds or stationary service.

FOR RIM AND WHEEL LOAD INFORMATION, SEE IMPORTANT NOTES ON PAGES 168-172.

TABLE C3 – AD₂ IF AND VF LOAD FOR RADIAL IMPLEMENT TIRES

TIRE TYPE NOMENCLATURE		MAX SPEED
TRA	TIRE TYPE	SPEED INDEX
I-1	Rib Tread	D-40 mph

BASIC TIRE LOAD RATINGS FOR TIRE SELECTION

TIRE SIZE	Psi kPa	LOAD LIMITS AT VARIOUS COLD INFLATION PRESSURES														
		35	38	41	44	46	49	52	55	58	61	64	67	70	73	75
		240	260	280	300	320	340	360	380	400	420	440	460	480	500	520
AD ₂ VF245/70R19.5	LI	120		124		127		130		134		137		140		142
	lbs	3080	3300	3520	3740	3860	4080	4180	4400	4680	4800	5080	5200	5520	5680	5840
	kg	1400	1500	1600	1700	1750	1850	1900	2000	2120	2180	2300	2360	2500	2575	2650
AD ₂ VF265/70R19.5	LI	124		128		131		135		138		141		144		146
	lbs	3520	3740	3960	4180	4300	4540	4800	4940	5200	5520	5680	5840	6150	6400	6600
	kg	1600	1700	1800	1900	1950	2060	2180	2240	2360	2500	2575	2650	2800	2900	3000
AD ₂ VF285/70R19.5	LI	128		132		135		139		142		145		147		150
	lbs	3960	4180	4400	4680	4800	5080	5360	5520	5840	6150	6400	6600	6800	7150	7400
	kg	1800	1900	2000	2120	2180	2300	2430	2500	2650	2800	2900	3000	3075	3250	3350
AD ₂ VF285/70R22.5	LI	124		129		132		135		139		142		144		146
	lbs	3520	3740	4080	4300	4400	4680	4800	5080	5360	5520	5840	6000	6150	6400	6600
	kg	1600	1700	1850	1950	2000	2120	2180	2300	2430	2500	2650	2725	2800	2900	3000
AD ₂ VF295/75R22.5	LI	134		139		142		145		148		151				
	lbs	4680	4940	5360	5680	5840	6000	6400	6600	6950	7400	7600				
	kg	2120	2240	2430	2575	2650	2725	2900	3000	3150	3350	3450				
AD ₂ VF385/65R22.5	LI	144		148		151		155		158		161		163		
	lbs	6150	6600	6950	7400	7600	8050	8550	8800	9350	9650	10200	10500	10700		
	kg	2800	3000	3150	3350	3450	3650	3875	4000	4250	4375	4625	4750	4875		
AD ₂ VF445/50R22.5	LI			148		151		155		158		160		163		166
	lbs			3150	3350	3450	3650	3875	4000	4250	4375	4500	4750	4875	5150	5300
	kg			6950	7400	7600	8050	8550	8800	9350	9650	9900	10500	10700	11400	11700
AD ₂ VF445/65R22.5	LI	152		156		159		162		166		169		171		174
	lbs	7850	8250	8800	9350	9650	10200	10500	11000	11700	12000	12800	13200	13600	13900	14800
	kg	3550	3750	4000	4250	4375	4625	4750	5000	5300	5450	5800	6000	6150	6300	6700

NOTES:

- There are no adjustments to the loads and pressures in the above tables for lower transport speeds or stationary service.

FOR RIM AND WHEEL LOAD INFORMATION, SEE IMPORTANT NOTES ON PAGES 168-172.

RADIAL FARM
 BIAS FARM
 FRONTS & IMPLEMENTS
 FORESTRY & FLOTATION
 DISCONTINUED
 LOAD & INFLATION TABLES
 GENERAL TIRE INFORMATION
 WARRANTY

TABLE E – DIAGONAL (BIAS) PLY AGRICULTURAL TRACTOR DRIVE WHEEL TIRES

TIRE TYPE NOMENCLATURE		MAX SPEED
TRA	TIRE TYPE	SPEED INDEX
		A8
R-1	Drive Wheel, Regular Tread	25 mph
R-2	Cane & Rice, Drive Wheel, Deep Tread	25 mph
R-3	Drive Wheel, Shallow Tread	25 mph
R-4	Industrial Tractor, Drive Wheel, Intermediate Tread	25 mph

TIRES USED AS SINGLES BASIC TIRE LOAD RATINGS FOR TIRE SELECTION

TIRE SIZE	INFLATION		LOAD LIMITS AT VARIOUS COLD INFLATION PRESSURES														
	psi		12	14	16	18	20	22	24	26	28	30	32				
	kPa		80	100	110	120	140	150	170	180	190	210	220				
7.5-22	lbs.		990	1100	1170	1280	1360 (4)										
	kg		450	500	530	580	615 (4)										
8.3-16	lbs.		640	715	760	825	880	935 (4)	965	1020	1070	1100	1140				1200@34 psi (6)
	kg		290	325	345	375	400	425 (4)	437	462	487	500	515				545@230 kPa (6)
8.3-22	lbs.		785	910	965	990	1100	1170 (4)	1230	1280	1320	1390	1430				1760@36 psi (6)
	kg		355	412	437	450	500	530 (4)	560	580	600	630	650				800@250 kPa (6)
8.3-24	lbs.		880	965	1020	1100	1170	1230 (4)									
	kg		400	437	462	500	530	560 (4)									
9.5-16	lbs.		825	910	965	1050	1100 (4)	1170	1230	1280	1360	1390 (6)					
	kg		375	412	437	475	500 (4)	530	560	580	615	630 (6)					
9.5-22	lbs.		990	1140	1200	1230	1360 (4)	1430	1520	1570	1650	1710	1760 (6)				
	kg		450	515	545	560	615 (4)	650	690	710	750	775	800 (6)				
9.5-24	lbs.		1100	1200	1280	1390	1480 (4)	1570	1650	1710	1820	1870 (6)					
	kg		500	545	580	630	670 (4)	710	750	775	825	850 (6)					
9.5-32	lbs.		1230	1360	1480	1570	1650 (4)	1760	1870	1930	2040	2090 (6)					
	kg		560	615	670	710	750 (4)	800	850	875	925	950 (6)					
9.5-36	lbs.		1320	1430	1570	1650	1760 (4)										
	kg		600	650	710	750	800 (4)										
9.5-42	lbs.		1430	1570	1650	1820	1930 (4)	2040	2150	2270	2340	2400 (6)	2540				2910@40 psi (8) 3200@48 psi (10)
	kg		650	710	750	825	875 (4)	925	975	1030	1060	1090 (6)	1150				1320@280 kPa (8) 1450@330 kPa (10)
11.2-24	lbs.		1320	1430	1570	1650 (4)	1760	1870	1980	2090 (6)	2150	2270	2340	2540@36 (8) psi			2830@44 psi (10)
	kg		600	650	710	750 (4)	800	850	900	950 (6)	975	1030	1060	1150@250 (8) kPa			1285@300 kPa (10)
11.2-28	lbs.		1390	1520	1650	1760 (4)	1930	1980	2090	2200 (6)							
	kg		630	690	750	800 (4)	875	900	950	1000 (6)							
11.2-36	lbs.		1570	1760	1870	2040 (4)											
	kg		710	800	850	925 (4)											
11.2-38	lbs.		1650	1760	1930	2090 (4)	2200	2340	2470	2540 (6)							
	kg		750	800	875	950 (4)	1000	1060	1120	1150 (6)							
12.4-16	lbs.		1200	1320	1430 (4)	1520	1650	1710	1820 (6)	1930	1980	2090	2150 (8)				2760@48 psi (12)
	kg		545	600	650 (4)	690	750	775	825 (6)	875	900	950	975 (8)				1250@330 kPa (12)
12.4-24	lbs.		1570	1710	1870 (4)	1980	2150	2270	2400 (6)	2470	2600	2680	2830 (8)				3520@48 psi (12)
	kg		710	775	850 (4)	900	975	1030	1090 (6)	1120	1180	1215	1285 (8)				1600@330 kPa (12)
12.4-28	lbs.		1710	1870	1980 (4)	2150	2270	2400	2540 (6)								
	kg		775	850	900 (4)	975	1030	1090	1150 (6)								

FOR RIM AND WHEEL LOAD INFORMATION, SEE IMPORTANT NOTES ON PAGES 168-172.

RADIAL FARM
BIAS FARM
FRONTS & IMPLEMENTS
FORESTRY & FLOTATION
DISCONTINUED
LOAD & INFLATION TABLES
GENERAL TIRE INFORMATION
WARRANTY

TABLE E — DIAGONAL (BIAS) PLY AGRICULTURAL TRACTOR DRIVE WHEEL TIRES

**TIRES USED AS SINGLES
BASIC TIRE LOAD RATINGS FOR TIRE SELECTION**

TIRE SIZE	INFLATION		LOAD LIMITS AT VARIOUS COLD INFLATION PRESSURES											
	psi		12	14	16	18	20	22	24	26	28	32		
	kPa		80	100	110	120	140	150	170	180	190	220		
12.4-36	lbs.	1930	2090	2270 (4)	2400	2540	2680	2830 (6)	3000	3080	3420 (8)			3860 @ 40 psi (10)
	kg	875	950	1030 (4)	1090	1150	1215	1285 (6)	1360	1400	1550 (8)			1750 @ 280 kPa (10)
12.4-38	lbs.	1980	2150	2340 (4)	2470	2600	2760	2910 (6)			3520 (8)	4400 @ 48 psi (12)		4800 @ 56 psi (14)
	kg	900	975	1060 (4)	1120	1180	1250	1320 (6)			1600 (8)	2000 @ 330 kPa (12)		2180 @ 385 kPa (14)
12.4-42	lbs.	2040	2270	2470 (4)	2600	2760	2910	3080 (6)	3200	3420	3640 (8)			4180 @ 40 psi (10)
	kg	925	1030	1120 (4)	1180	1250	1320	1400 (6)	1450	1550	1650 (8)			1900 @ 280 kPa (10)
13.6-16	lbs.	1430	1570 (4)											
	kg	650	710 (4)											
13.6-24	lbs.	*1870	2040 (4)	2200	2340	2540	2680 (6)	2830	2910	3080 (8)				
	kg	*850	925 (4)	1000	1060	1150	1215 (6)	1285	1320	1400 (8)				
13.6-26	lbs.	1930	2090 (4)	2270	2470	2600	2760 (6)	2910	3000	3200 (8)				
	kg	875	950 (4)	1030	1120	1180	1250 (6)	1320	1360	1450 (8)				
13.6-28	lbs.	*1980	2200 (4)	2340	2540	2680	2830 (6)	3000	3080	3300 (8)	3520	3740 @ 36 psi (10)		4180 @ 42 psi (12)
	kg	*900	1000 (4)	1060	1150	1215	1285 (6)	1360	1400	1500 (8)	1600	1700 @ 250 kPa (10)		1900 @ 290 kPa (12)
13.6-36	lbs.	*2270	2470 (4)	2680	2830	3000	3200 (6)							
	kg	*1030	1120 (4)	1215	1285	1360	1450 (6)							
13.6-38	lbs.	2340	2540 (4)	2760	2910	3080	3300 (6)							
	kg	1060	1150 (4)	1250	1320	1400	1500 (6)							
13.6-46	lbs.	2540	2830 (4)	3000	3200	3420	3640 (6)	3860	4080	4180 (8)				
	kg	1150	1285 (4)	1360	1450	1550	1650 (6)	1750	1850	1900 (8)				
14.9-24	lbs.	*2200	2400 (4)	2600	2830	3000 (6)	3200	3300	3520 (8)	3640	3960			4400 @ 38 psi (12)
	kg	*1000	1090 (4)	1180	1285	1360 (6)	1450	1500	1600 (8)	1650	1800			2000 @ 260 kPa (12)
14.9-26	lbs.	*2270	2540	2680	2910	3080 (6)	3300	3420	3640	3740	4080(10)			
	kg	*1030	1150	1215	1320	1400 (6)	1500	1550	1650	1700	1850(10)			
14.9-28	lbs.	*2340	2600 (4)	2830	3000	3200 (6)	3420	3520	3740 (8)	3860	4180(10)			
	kg	*1060	1180 (4)	1285	1360	1450 (6)	1550	1600	1700 (8)	1750	1900(10)			
14.9-30	lbs.	*2470	2680	2910	3080	3300 (6)	3520	3640	3860 (8)	3960	4300(10)			
	kg	*1120	1215	1320	1400	1500 (6)	1600	1650	1750 (8)	1800	1950(10)			
14.9-38	lbs.	*2760	3000	3300	3520	3740 (6)	3960	4180	4300 (8)	4540	4940(10)			5360 @ 38 psi (12)
	kg	*1250	1360	1500	1600	1700 (6)	1800	1900	1950 (8)	2060	2240(10)			5840 @ 44 psi (14)
15.5-38	lbs.	*2600	2830	3080	3300	3520 (6)	3740	3860	4080 (8)					
	kg	*1180	1285	1400	1500	1600 (6)	1700	1750	1850 (8)					
16.9-24	lbs.	*2680	*2910	3200	3420 (6)	3640	3860	4080 (8)	4300	4400(10)				
	kg	*1215	*1320	1450	1550 (6)	1650	1750	1850 (8)	1900	2000(10)				
16.9-26	lbs.	*2760	*3080	3300	3520 (6)	3740	3960	4180	4400	4540(10)				
	kg	*1250	*1400	1500	1600 (6)	1700	1800	1900	2000	2060(10)				
16.9-28	lbs.	*2910	*3200	3420	3640 (6)	3860	4080	4300 (8)	4540	4680(10)				
	kg	*1320	*1450	1550	1650 (6)	1750	1850	1950 (8)	2060	2120(10)				
16.9-30	lbs.	*3000	*3300	3520	3740 (6)	3960	4180	4400 (8)	4680	4940(10)				5520 @ 34 psi (12)
	kg	*1360	*1500	1600	1700 (6)	1800	1900	2000 (8)	2120	2240(10)				2500 @ 230 kPa (12)
16.9-34	lbs.	*3200	*3420	3740	3960 (6)	4300	4540	4680 (8)	4940	5200(10)				
	kg	*1450	*1550	1700	1800 (6)	1950	2060	2120 (8)	2240	2360(10)				
16.9-38	lbs.	*3300	*3640	3960	4180 (6)	4540	4800	4940 (8)						
	kg	*1500	*1650	1800	1900 (6)	2060	2180	2240 (8)						

FOR RIM AND WHEEL LOAD INFORMATION, SEE IMPORTANT NOTES ON PAGES 168-172.

RADIAL FARM

BIAS FARM

FRONTS & IMPLEMENTS

FORESTRY & FLOTATION

DISCONTINUED

LOAD & INFLATION TABLES

GENERAL TIRE INFORMATION

WARRANTY

TABLE E — DIAGONAL (BIAS) PLY AGRICULTURAL TRACTOR DRIVE WHEEL TIRES

TIRES USED AS SINGLES BASIC TIRE LOAD RATINGS FOR TIRE SELECTION

TIRE SIZE	INFLATION		LOAD LIMITS AT VARIOUS COLD INFLATION PRESSURES											
	psi		12	14	16	18	20	22	24	26	28	30		32
	kPa		80	100	110	120	140	150	170	180	190	210		220
18.4-16.1	lbs.	*2150	*2340	2540 (6)	2680	2910 (8)	3080	3200	3300 (10)					
	kg	*975	*1060	1150 (6)	1215	1320 (8)	1400	1450	1500 (10)					
18.4-26	lbs.	*3300	*3640	3960 (6)	4180	4540 (8)	4800	4940	5200 (10)	5520	5680	5840 (12)		
	kg	*1500	*1650	1800 (6)	1900	2060 (8)	2180	2240	2360 (10)	2500	2575	2650 (12)		
18.4-28	lbs.	*3420	*3740	4080 (6)	4400	4680 (8)	4940	5200	5360 (10)	5680	5840	6150 (12)		
	kg	*1550	*1700	1850 (6)	2000	2120 (8)	2240	2360	2430 (10)	2575	2650	2800 (12)		
18.4-30	lbs.	*3520	*3860	4180 (6)	4540	4800 (8)	5080	5360	5520 (10)	5840	6150	6400 (12)		
	kg	*1600	*1750	1900 (6)	2060	2180 (8)	2300	2430	2500 (10)	2650	2800	2900 (12)		
18.4-34	lbs.	*3740	*4180	4400 (6)	4800	5080 (8)	5360	5680	6000	6150	6400	6600 (12)		
	kg	*1700	*1900	2000 (6)	2180	2300 (8)	2430	2575	2725	2800	2900	3000 (12)		
18.4-38	lbs.	*3960	*4400	4680 (6)	5080	5360 (8)	5680	6000	6400 (10)	6600	6800	7150 (12)	7600 @ 36 psi (14)	
	kg	*1800	*2000	2120 (6)	2300	2430 (8)	2575	2725	2900 (10)	3000	3075	3250 (12)	3450@250 kPa (14)	
18.4-42	lbs.	*4180	*4680	4940	5360	5680 (8)	6000	6400	6600 (10)	6950	7150	7400 (12)		
	kg	*1900	*2120	2240	2430	2575 (8)	2725	2900	3000 (10)	3150	3250	3350 (12)		
18.4-46	lbs.	*4400	*4800	5200	5680	6000	6400	6600	6950	7400	7600	7850	8550 @ 36 psi (14)	
	kg	*2000	*2180	2360	2575	2725	2900	3000	3150	3350	3450	3550	3450@250 kPa (14)	
20.8-34	lbs.	*4540	*4940	5360	5840 (8)	6150	6600 (10)							
	kg	*2060	*2240	2430	2650 (8)	2800	3000 (10)							
20.8-38	lbs.	*4800	*5360	5680	6150 (8)	6600	6950 (10)	7150	7600	7850 (12)	8250	8550 (14)		
	kg	*2180	*2430	2575	2800 (8)	3000	3150 (10)	3250	3450	3550 (12)	3750	3875 (14)		
20.8-42	lbs.	*5080	*5520	6000	6400	6950	7400 (10)	7600	8050	8550 (12)	8800	9100 (14)		
	kg	*2300	*2500	2725	2900	3150	3350 (10)	3450	3650	3875 (12)	4000	4125 (14)		
23.1-26	lbs.	*4800	*5200	5680 (8)	6000	6400 (10)	6800	7150 (12)	7600	7850 (14)				
	kg	*2180	*2360	2575 (8)	2725	2900 (10)	3075	3250 (12)	3450	3550 (14)				
23.1-30	lbs.	*5080	*5520	6000 (8)	6400	6800 (10)		7600 (12)						
	kg	*2300	*2500	2725 (8)	2900	3075 (10)		3450 (12)						
23.1-34	lbs.	*5360	*5840	6400 (8)	6800	7400 (10)								
	kg	*2430	*2650	2900 (8)	3075	3350 (10)								
24.5-32	lbs.	*5840	*6400	6800	7400	7850 (10)	8250	8800 (12)	9100	9650 (14)		10400(16)		
	kg	*2650	*2900	3075	3350	3550 (10)	3750	4000 (12)	4125	4375 (14)		4725(16)		
420.70-24	lbs.	2340	2540	2760 (6)	2910	3080	3300 (8)	3520	3640 (10)					
	kg	1060	1150	1250 (6)	1320	1400	1500 (8)	1600	1650 (10)					
17.5L-24	lbs.	2600	2830	3080 (6)	3300	3520	3640 (8)	3860	4080	4180 (10)				
	kg	1180	1285	1400 (6)	1500	1600	1650 (8)	1750	1850	1900 (10)				
19.5L-24	lbs.	3080	3420	3640	3860	4180 (8)	4400	4680 (10)	4800	5080	5200 (12)			
	kg	1400	1550	1650	1750	1900 (8)	2000	2120 (10)	2180	2300	2360 (12)			
21L-28	lbs.	3860	4180 (6)	4540	4800 (8)	5200	5560 (10)	5840	6000	6150 (12)	6600	6800 (14)		
	kg	1750	1900 (6)	2060	2180 (8)	2360	2500 (10)	2650	2725	2800 (12)	3000	3075 (14)		
21.5L-16.1	lbs.	2760 (6)	3000	3200	3420 (8)	3640	3860 (10)							
	kg	1250 (6)	1360	1450	1550 (8)	1650	1750 (10)							
24L-26	lbs.	4300 (6)	4800	5080 (8)	5520	5840 (10)	6150	6600 (12)						
	kg	1950 (6)	2180	2300 (8)	2500	2650 (10)	2800	3000 (12)						
28L-26	lbs.	5520	6000	6600	6950 (10)	7400 (12)	7850	8250 (14)	8800	9100 (16)				
	kg	2500	2725	3000	3150 (10)	3350 (12)	3560	3740 (14)	4000	4125 (16)				
30.5L-32	lbs.	6950 (8)	7600	8250 (10)	8800	9350 (12)	9900 (14)	10500	11000(16)					
	kg	3150 (8)	3450	3750 (10)	4000	4250 (12)	4500 (14)	4750	5000 (16)					

FOR RIM AND WHEEL LOAD INFORMATION, SEE IMPORTANT NOTES ON PAGES 168-172.

RADIAL FARM

BIAS FARM

FRONTS & IMPLEMENTS

FORESTRY & FLOTATION

DISCONTINUED

LOAD & INFLATION TABLES

GENERAL TIRE INFORMATION

WARRANTY

TABLE E — DIAGONAL (BIAS) PLY AGRICULTURAL TRACTOR DRIVE WHEEL TIRES

TIRES USED AS SINGLES BASIC TIRE LOAD RATINGS FOR TIRE SELECTION

TIRE SIZE	INFLATION		LOAD LIMITS AT VARIOUS COLD INFLATION PRESSURES									
	psi	12	14	16	18	20	22	24	26	28	30	32
	kPa	80	100	110	120	140	150	170	180	190	210	220
35.5L-32	lbs.	9350	10200 (10)	11000 (12)	11700 (14)	12800	13200 (16)	13900 (18)	14800	15200 (20)	16100 (22)	16500 (24)
	kg	4250	4625 (10)	5000 (12)	5300 (14)	5800	6000 (16)	6300 (18)	6700	6900 (20)	7300 (22)	7500 (24)

TIRE SIZE	INFLATION		LOAD LIMITS AT VARIOUS COLD INFLATION PRESSURES												
	psi	23	26	29	32	35	38	41	44	46	49	52	58	61	64
	kPa	160	180	200	220	240	260	280	300	320	340	360	400	420	440
520/85D38	LI	155		158		160		164		167		169	170		173
	lbs.	8550	9100	9350	9650	9900	10500	11000	11400	12000	12300	12800	13200	13900	14300
	kg	3875	4125	4250	4375	4500	4750	5000	5150	5450	5600	5800	6000	6300	6500

NOTES:

- Figures in parentheses denote ply rating for which boldface loads and inflations are maximum.
- For shipping purposes, tire inflation pressures may be increased to 30 psi (210 kPa). Consult tire manufacturer for minimum tire shipping pressure. Inflation pressure must be reduced to operating inflation before the machine is removed from the carrier.
- When used as duals, tire loads must be reduced 12%. (Multiply figures in above table at .88.)
- When used as triples, tire loads must be reduced 18%. Multiply figures in above table by .82.)
- For R-3 tires used in free rolling service at speeds up to 10 mph (15 km/h), maximum above loads may be increased 50% with a 4 psi (30 kPa) increase in inflation pressure.
- For R-4 tires in transport service, see Table G, page 142.
- The above loads are also applicable to equipment, including hillside combines, operating on slopes above 11° (20% grade). Load adjustments below 20 mph (30 km/h) do not apply.
- For cyclic loading field service, see Table F2 on page 138. For tire sizes not shown, see Note 4 on page 140.
- For R-1, R-2 and R-3 tires in transport service and operations that do not require sustained high torque, the load limits shown at right at various speeds apply.

MAX. SPEED	% CHANGE IN ABOVE LOADS	% CHANGE IN INFL. PRESSURE
Stationary	+200%	30%
10 mph (15 km/h)	+34% (except hillside combines)	None
15 mph (25 km/h)	+22% (except hillside combines)	None
20 mph (30 km/h)	+11%	None
25 mph (40 km/h)	Same As Table	None

FOR RIM AND WHEEL LOAD INFORMATION, SEE IMPORTANT NOTES ON PAGES 168-172.

TABLE F1 – RADIAL PLY AGRICULTURAL DRIVE WHEEL TIRES USED ON AGRICULTURAL HARVESTING EQUIPMENT IN CYCLIC LOADING FIELD SERVICE AND ROAD TRANSPORT (EXCLUDING HILLSIDE COMBINES)

TIRES USED AS SINGLES BASIC TIRE LOAD RATINGS FOR TIRE SELECTION

TIRE SIZE	BASIC TIRE LOAD INDEX NO.	CYCLIC INFLATION PRESSURE		FIELD SERVICE MAXIMUM CYCLIC LOAD				ROAD TRANSPORT MAXIMUM LOAD	
		psi	kPa	MAX. SPEED 6 MPH (10 KM/H)		MAX. SPEED 10 MPH (15 KM/H)		MAX. SPEED 25 MPH (40 KM/H)	
				lbs	kg	lbs	kg	lbs	kg
14.9R26	132	38	260	7480	3390	6820*	3090*	5000	2270
16.9R24	134	30	210	7960	3610	7250*	3290*	5080	2300
16.9R26	135 (2*)	30	210	8150	3700	7450*	3380*	5360	2430
18.4R26	140 (2*)	30	210	9400	4260	8550*	3880*	6400	2900
18.4R38	141 (1*)	24	160	9650	4380	8800*	4000*	6600	3000
	146 (2*)	30	210	11200	5100	10200*	4640*	7600	3450
18.4R42	148 (2*)	30	210	11800	5360	10800*	4880*	8050	3650
20.8R38	147 (1*)	24	160	11600	5240	10500*	4760*	8050	3650
	153 (2*)	30	210	13700	6200	12500*	5660*	9100	4125
20.8R42	155 (2*)	30	210	14500	6600	13300*	6000*	9650	4375
24.5R32	154	24	170	14030	6360	12790*	5800*	9650	4375
30.5LR32	170 (3*)	36	250	22400	10200	20500*	9300*	14800	6700
380/90R46	149	41	280	12200	5540	11100*	5040*	7850	3550
420/80R46	149	35	240	12200	5540	11100*	5040*	7600	3450
	151	44	300	12900	5870	11800*	5350*	8250	3750
	161	70	480	17300	7860	15800*	7170*	11000	5000
420/85R26	138	29	200	8840	4010	8060*	3660*	5680	2575
480/70R28	151	52	360	12900	5860	11800*	5340*	8250	3750
480/70R30	152	58	400	13340	6060	12160*	5530*	8800	4000
480/80R38	149	29	200	12150	5520	11080*	5030*	7850	3550
480/80R42	151	29	200	12900	5870	11800*	5350*	8250	3750
	154	35	240	14000	6350	12800*	5800*	8800	4000
520/85R38	155	29	200	14500	6600	13300*	6000*	9350	5240
520/85R42	157	29	200	15450	7020	14100*	6400*	9900	4500
	165	51	350	19400	8760	17700*	7980*	12300	5600
540/65R30	150	41	280	12580	5700	11470*	5200*	8050	3650
580/85R42	168	44	300	20900	9520	19100*	8680*	13600	6150
600/65R28	147	29	200	11600	5260	10500*	4760*	7850	3550
	154	44	300	14020	6370	12780*	5810*	9350	4250
600/70R28	164	58	400	18700	8500	17100*	7750*	11700	11700
600/70R30	152	29	200	13340	6060	12160*	5530*	8800	4000
	162	52	360	17850	8100	16200*	7360*	12000	5450
620/70R42	160	29	200	16830	7650	15340*	6970*	11000	5000
	166	41	280	19890	9040	18130*	8240*	12800	5800
650/75R32	167	41	280	20400	9250	18600*	8450*	12800	5800
	172	52	360	23600	10700	21500*	9750*	14800	6700
650/85R38	173	41	280	24300	11050	22150*	10070*	15700	7100
750/65R26	166	44	300	19890	9040	18130*	8240*	13200	6000
800/60R32	175	58	400	25840	11740	23560*	10700*	17100	7770

*Values at these inflation pressures are for determination of dual loads only

FOR RIM AND WHEEL LOAD INFORMATION, SEE IMPORTANT NOTES ON PAGES 168-172.

RADIAL FARM

BIAS FARM

FRONTS & IMPLEMENTS

FORESTRY & FLOTATION

DISCONTINUED

LOAD & INFLATION TABLES

GENERAL TIRE INFORMATION

WARRANTY

TABLE F1 – RADIAL PLY AGRICULTURAL DRIVE WHEEL TIRES USED ON AGRICULTURAL HARVESTING EQUIPMENT IN CYCLIC LOADING FIELD SERVICE AND ROAD TRANSPORT (EXCLUDING HILLSIDE COMBINES)

TIRES USED AS SINGLES BASIC TIRE LOAD RATINGS FOR TIRE SELECTION

TIRE SIZE	BASIC TIRE LOAD INDEX NO.	CYCLIC INFLATION PRESSURE		FIELD SERVICE MAXIMUM CYCLIC LOAD				ROAD TRANSPORT MAXIMUM LOAD	
				MAX. SPEED 6 MPH (10 KM/H)		MAX. SPEED 10 MPH (15 KM/H)		MAX. SPEED 25 MPH (40 KM/H)	
		psi	kPa	lbs	kg	lbs	kg	lbs	kg
800/65R32	167	29	200	20400	9250	18600*	8450*	12800	5800
	172	41	280	23600	10700	21500*	9750*	15200	6900
800/70R38	173	29	200	24300	11050	22150*	10070*	15700	7100
	181	52	360	30940	14060	28210*	12800*	20900	9500
900/60R32	176	41	280	26700	12100	24300*	11000*	17100	7750
900/65R32	178	44	300	28050	12750	25570*	11620*	19300	8770
900/75R32	184	44	300	33660	15300	30690*	13950*	22700	10300

NOTES:

- For tires used in dual service, above tire load limits must be reduced. Multiply figures in the above table by .88.
- The load ratings in the above table reflect a different operating duty cycle when compared with agricultural tractors. This cyclic service is intended for use on a vehicle with a minimal requirement for torque transmission and with appreciable total weight fluctuations: e.g., combine grain tanks, which are repeatedly filled and emptied. Unloading is to occur before off-field transport.
- For intermediate inflation pressures and for tires not shown, the field service loads in Tables A and B (pages 92-117) may be increased by 70% for 6 mph (10 km/h) applications and 55% for 10 mph (15 km/h) applications with an increase in inflation pressure of up to 25% with a minimum of +6 psi (+40 kPa) and a maximum of +12 psi (+80 kPa).
- Due to higher inflation pressures specified for these tires, the tire and wheel manufacturer must be consulted.
- The above field service cyclic loads only apply to vehicles that operate up to an 11° slope (20% grade). For operations on slopes greater than 11° (20% grade), loads in Tables A and B shall be used.
- *For tires used on grain carts, the field service loads in Tables A and B may be increased by 55% for 15 mph (25 km/h), up to 1 mile (1.61 km), with an increase in inflation pressure of up to 25% with a minimum of +6 psi (+40 kPa) and a maximum of +12 psi (+80 kPa).

FOR RIM AND WHEEL LOAD INFORMATION, SEE IMPORTANT NOTES ON PAGES 168-172.

TABLE F2 –

IF CFO RADIAL PLY AGRICULTURAL DRIVE WHEEL TIRES USED ON AGRICULTURAL HARVESTING EQUIPMENT IN CYCLIC LOADING FIELD SERVICE AND ROAD TRANSPORT (EXCLUDING HILLSIDE COMBINES)

TIRE TYPE NOMENCLATURE	
TRA	TIRE TYPE
R-1	Drive Wheel, Regular Tread
R-2	Cane & Rice, Drive Wheel, Deep Tread
R-3	Drive Wheel, Shallow Tread
R-4	Industrial Tractor, Drive Wheel, Intermediate Tread

TIRES USED AS SINGLES

BASIC TIRE LOAD RATINGS FOR TIRE SELECTION

TIRE SIZE	BASIC TIRE LOAD INDEX NO.	CYCLIC INFLATION PRESSURE		FIELD SERVICE MAXIMUM CYCLIC LOAD				ROAD TRANSPORT MAXIMUM LOAD	
		psi	kPa	MAX. SPEED 10 MPH (15 KM/H)		MAX. SPEED 20 MPH (30 KM/H)		MAX. SPEED 30 MPH (50 KM/H)	
				lbs	kg	lbs	kg	lbs	kg
IF520/85R42CFO	169	35	240	19800	9000	16600	7550	12800	5800
IF580/85R42CFO	178	41	280	25600	11600	21500	9750	16500	7500
IF710/70R42CFO	179	35	240	26500	12000	22200	10100	17100	7750
IF800/70R38CFO	190	46	320	36300	16400	30400	13800	23400	10600
IF850/75R42CFO	186	23	160	32400	14700	27200	12400	20900	9500
IF900/60R32CFO	182	35	240	29000	13200	24300	11100	18700	8500
IF900/60R32CFO	188	46	320	34100	15500	28600	13000	22000	10000
IF900/75R32CFO	178	17	120	25600	11600	21500	9750	16500	7500
IF1100/50R42CFO	197	46	320	43900	19900	36800	16700	28300	12850
IF1250/50R32CFO	188	23	160	34100	15500	28600	13000	22000	10000
IF1250/50R32CFO	195	35	240	41500	18800	34800	15800	26800	12150
IF1250/50R32CFO	201	46	320	49600	22500	41600	18900	32000	14500

NOTES:

- For tires used in dual service, above tire load limits must be reduced. Multiply figures in the above table by .88.
- The load ratings in the above table reflect a different operating duty cycle when compared with agricultural tractors. This cyclic service is intended for use on a vehicle with a minimal requirement for torque transmission and with appreciable total weight fluctuations: e.g., combine grain tanks, which are repeatedly filled and emptied. Unloading is to occur before off-field transport.
- For intermediate inflation pressures and for tires not shown with the CFO suffix, the field service loads in Table C (pages 118-125) may be increased by 55% for 10 mph (15 km/h) or slower applications and 30% for greater than 10 mph (15 km/h) up to 20 mph (30 km/h) applications for a given inflation pressure.
- Due to higher load capacities specified for these tires, the tire and wheel manufacturer must be consulted.
- The above field service cyclic loads only apply to vehicles, that operate up to an 11° (20%) lateral slope. For operations on slopes greater than 11° (20%) lateral slope, loads in Table C (pages 118-125) shall be used.
- For tires used on grain carts, the field service loads in Table C1 (pages 118-125) may be increased by 55% for speeds up to 20 mph (30 km/h) and distances up to 1 mile (1.61 km) with no increase in inflation pressure.**

FOR RIM AND WHEEL LOAD INFORMATION, SEE IMPORTANT NOTES ON PAGES 168-172.

TABLE F3 – DIAGONAL (BIAS) PLY AGRICULTURAL DRIVE WHEEL TIRES USED ON AGRICULTURAL HARVESTING EQUIPMENT IN CYCLIC LOADING FIELD SERVICE AND ROAD TRANSPORT (EXCLUDING HILLSIDE COMBINES)

**TIRES USED AS SINGLES
BASIC TIRE LOAD RATINGS FOR TIRE SELECTION**

TIRE SIZE	BASIC TIRE LOAD INDEX NO.	CYCLIC INFLATION PRESSURE		FIELD SERVICE MAXIMUM CYCLIC LOAD				ROAD TRANSPORT MAXIMUM LOAD	
				MAX. SPEED 6 MPH (10 KM/H)		MAX. SPEED 10 MPH (15 KM/H)		MAX. SPEED 25 MPH (40 KM/H)	
		psi	kPa	lbs	kg	lbs	kg	lbs	kg
14.9-24	6	26	180	5620	2540	5100*	2310*	3520	1600
	8	34	230	6600	3000	5980*	2710*	4080	1850
	12	50	340	8200	3740	7500*	3400*	5080	2300
14.9-26	6	26	180	5760	2610	5240*	2380*	3640	1650
	10	42	290	7650	3480	6950*	3160*	4800	2180
16.9-26	6	24	170	6600	3000	5980*	2710*	4180	1900
	10	36	250	8500	3860	7700*	3500*	5360	2430
16.9-30	6	24	170	7000	3180	6350*	2890*	4400	2000
	10	36	250	9250	4200	8400*	3820*	5680	2575
	14	52	360	11200	5080	10200*	4620*	6950	3150
18.4-26	6	20	140	7400	3360	6750*	3060*	4540	2060
	10	34	230	9700	4420	8850*	4020*	6150	2800
	12	42	290	10600	4820	9650*	4390*	—	—
18.4-30	6	20	140	7800	3540	7100*	3220*	4800	2180
	8	26	180	9000	4080	8150*	3700*	5520	2500
	10	34	230	10300	4680	9400*	4260*	6600	3000
18.4-38	8	26	180	10000	4540	9100*	4130*	6400	2900
	10	34	230	12000	5440	10900*	4940*	7400	3350
	12	42	290	13400	6050	12200*	5540*	8250	3750
	14	46	320	14200	6450	12900*	5860*	8800	4000
18.4-42	10	34	230	12300	5620	11200*	5100*	7850	3550
	14	44	300	15100	6850	13700*	6200*	9100	4125
20.8-38	8	24	170	11500	5220	10500*	4760*	7150	3250
	10	28	190	13000	5900	11800*	5360*	7850	3550
	14	42	290	16000	7250	14500*	6600*	10200	4625
520/85D38	173LI	76	530	26740	12150	24300*	11050*	15700	7100
20.8-42	10	28	190	13800	6250	12600*	5700*	8250	3750
	14	42	290	17000	7700	15500*	7050*	10700	4875
23.1-26	8	22	150	10600	4820	9650*	4380*	6800	3075
	10	26	180	12000	5440	10900*	4840*	7600	3450
	12	32	220	13400	6100	12200*	5520*	8550	3875
	14	36	250	14700	6650	13300*	6050*	9100	4125
24.5-32	10	26	180	14700	6650	13300*	6050*	9100	4125
	12	32	220	16500	7500	15000*	6800*	10200	4625
	16	40	270	18500	8420	16830*	7650*	11700	5300
28L-26	10	24	170	13000	5900	11800*	5360*	8250	3750
	12	26	180	13800	6250	12600*	5700*	8800	4000
	14	32	220	15300	7010	14000*	6380*	9900	4500
	16	38	260	17000	7710	15500*	7010*	11000	5000
30.5L-32	12	26	180	17500	7950	15900*	7250*	11000	5000
	14	28	190	18500	8400	16800*	7600*	11400	5150
	16	34	230	20600	9350	18700*	8500*	12800	5800
VA35.5L-32	12	20	140	20600	9350	18700*	8500*	12800	5800
	20	36	250	28400	12900	25900*	11700*	17600	8000

FOR RIM AND WHEEL LOAD INFORMATION, SEE IMPORTANT NOTES ON PAGES 168-172.



RADIAL FARM
BIAS FARM
FRONTS & IMPLEMENTS
FORESTRY & FLOTATION
DISCONTINUED
LOAD & INFLATION TABLES
GENERAL TIRE INFORMATION
WARRANTY

TABLE F3 –

DIAGONAL (BIAS) PLY AGRICULTURAL DRIVE WHEEL TIRES USED ON AGRICULTURAL HARVESTING EQUIPMENT IN CYCLIC LOADING FIELD SERVICE AND ROAD TRANSPORT (EXCLUDING HILLSIDE COMBINES)

TIRES USED AS SINGLES

BASIC TIRE LOAD RATINGS FOR TIRE SELECTION

TIRE SIZE	BASIC TIRE LOAD INDEX NO.	CYCLIC INFLATION PRESSURE		FIELD SERVICE MAXIMUM CYCLIC LOAD				ROAD TRANSPORT MAXIMUM LOAD	
				MAX. SPEED 6 MPH (10 KM/H)		MAX. SPEED 10 MPH (15 KM/H)		MAX. SPEED 25 MPH (40 KM/H)	
		psi	kPa	lbs	kg	lbs	kg	lbs	kg
DH35.5L-32	16	28	190	24700	11200	22400*	10200*	15200	6900

NOTES:

1. For tires used in dual service, above tire load limits must be reduced. Multiply figures in the above table by .88.
2. The load ratings in the above table reflect a different operating duty cycle when compared with agricultural tractors. This cyclic service is intended for use on a vehicle with a minimal requirement for torque transmission and with appreciable total weight fluctuations: e.g., combine grain tanks, which are repeatedly filled and emptied. Unloading is to occur before off-field transport.
3. For log-skidder tires with the same size and ply rating, the above cyclic and road transport loads can be applied.
4. For intermediate inflation pressures and for tires not shown, the field service loads in Table E (pages 132-135) may be increased by 87% for 6 mph (10 km/h) applications and 70% for 10 mph (15 km/h) applications with a 30% increase in inflation pressure. Consult tire manufacturer for loads and pressures not shown for transport service.
5. The above road transport loads apply to all speeds up to and including 25 mph (40 km/h).
6. Due to the higher inflation pressures specified for these tires, the tire and wheel manufacturer must be consulted.
7. The above field service cyclic loads only apply to vehicles that operate up to an 11° slope (20% grade). For operations on slopes greater than 11° (20% grade), loads in Table E shall be used.
8. ***For tires used on grain carts, the field service loads in Table E may be increased by 70% for 15 mph (25 km/h), up to 1 mile (1.61 km), with a 30% increase in inflation pressure.**

RADIAL FARM

BIAS FARM

FRONTS & IMPLEMENTS

FORESTRY & FLOTATION

DISCONTINUED

LOAD & INFLATION TABLES

GENERAL TIRE INFORMATION

WARRANTY

FOR RIM AND WHEEL LOAD INFORMATION, SEE IMPORTANT NOTES ON PAGES 168-172.

TABLE F4 – VF CFO RADIAL PLY AGRICULTURAL DRIVE WHEEL TIRES USED ON AGRICULTURAL HARVESTING EQUIPMENT IN CYCLIC LOADING FIELD SERVICE AND ROAD TRANSPORT (EXCLUDING HILLSIDE COMBINES)

TIRE TYPE NOMENCLATURE	
TRA	TIRE TYPE
R-1	Drive Wheel, Regular Tread
R-2	Cane & Rice, Drive Wheel, Deep Tread
R-3	Drive Wheel, Shallow Tread
R-4	Industrial Tractor, Drive Wheel, Intermediate Tread

TIRES USED AS SINGLES

BASIC TIRE LOAD RATINGS FOR TIRE SELECTION

TIRE SIZE	BASIC TIRE LOAD INDEX NO.	CYCLIC INFLATION PRESSURE		FIELD SERVICE MAXIMUM CYCLIC LOAD				ROAD TRANSPORT MAXIMUM LOAD	
				MAX. SPEED 10 MPH (15 KM/H)		MAX. SPEED 20 MPH (30 KM/H)		MAX. SPEED 30 MPH (50 KM/H)	
		psi	kPa	lbs	kg	lbs	kg	lbs	kg
VF520/85R42CFO	177	41	280	21500	9750	18100	8200	16100	7300
VF580/85R42CFO	183	41	280	25600	11600	21500	9750	19300	8750
VF600/70R28CFO	173	41	280	18600	8450	15600	7100	14300	6500
VF620/75R26CFO	172	35	240	18600	8450	15600	7100	13900	6300
VF710/70R42CFO	184	35	240	26500	12000	22200	10100	19800	9000
VF750/65R26CFO	177	35	240	21500	9750	18100	8200	16100	7300
VF800/70R38CFO	193	41	280	33300	15100	28000	12700	25400	11500
VF900/60R32CFO	193	46	320	34100	15500	28600	13000	25400	11500

NOTES:

- For tires used in dual service, above tire load limits must be reduced. Multiply figures in the above table by .88.
- The load ratings in the above table reflect a different operating duty cycle when compared with agricultural tractors. This cyclic service is intended for use on a vehicle with a minimal requirement for torque transmission and with appreciable total weight fluctuations: e.g., combine grain tanks, which are repeatedly filled and emptied. Unloading is to occur before off-field transport.
- For "CFO"-designated VF sizes and/or load indices not shown above, consult the tire manufacturer for the appropriate loads.
- Field service cyclic loads for "CFO"-designated VF sizes only apply to vehicles which operate up to an 11° (20%) lateral slope. For operations on slopes greater than 11° (20%) lateral slope, loads in Table VF-1 shall be used.
- For grain cart applications, the ≤ 10 mph (15 km/h) loads may be used at speeds up to 20 mph (30 km/h) and distances up to one mile (1.6 km).
- Due to the higher load capacities of these tires, consult both tire and wheel manufacturers for maximum load limitations.

FOR RIM AND WHEEL LOAD INFORMATION, SEE IMPORTANT NOTES ON PAGES 168-172.

TABLE G – DIAGONAL (BIAS) PLY AGRICULTURAL R-4 DRIVE WHEEL TIRES USED ON INDUSTRIAL TRACTORS

TIRE TYPE NOMENCLATURE		MAX SPEED
TRA	TIRE TYPE	SPEED INDEX
R-4	Industrial Tractor, Drive Wheel, Intermediate Tread	A8 25 mph

TIRES USED AS SINGLES BASIC TIRE LOAD RATINGS FOR TIRE SELECTION

TIRE SIZE	INFLATION		LOAD LIMITS AT VARIOUS COLD INFLATION PRESSURES								
	psi		18	20	22	24	26	28	30	32	
	kPa		120	140	150	170	180	190	210	220	
14.9-24	lbs.	3520	3740	4080	4300 (6)	4540	4800	5080 (8)	5200	6400 (12) @ 42 psi	
	kg	1600	1700	1850	1950 (6)	2060	2180	2300 (8)	2360	2900 (12) @ 280 kPa	
420/70-24	lbs.		3640	3960 (6)	4180	4540	4800 (8)	5080	5200 (10)		
	kg		1650	1800 (6)	1900	2060	2180 (8)	2300	2360 (10)		
14.9-28	lbs.	3740	4080	4300	4680 (6)	4940	5080	5360 (8)	5680	6150 (10) @ 36 psi	
	kg	1700	1850	1950	2120 (6)	2240	2300	2430 (8)	2575	2800 (10) @ 250 kPa	
16.9-24	lbs.		4680	4940 (6)	5200	5520	5840 (8)	6150	6400 (10)	7150 (12) @ 38 psi	
	kg		2120	2240 (6)	2360	2500	2650 (8)	2800	2900 (10)	3250 (12) @ 260 kPa	
16.9-28	lbs.		4940	5200 (6)	5680	6000	6150 (8)	6600	6800 (10)	7600 (12) @ 38 psi	
	kg		2240	2360 (6)	2575	2725	2800 (8)	3000	3075 (10)	3450 (12) @ 260 kPa	
18.4-28	lbs.		5840 (6)	6400	6800 (8)	7150	7400	7850 (10)	8250	8800 (12) @ 36 psi	
	kg		2650 (6)	2900	3075 (8)	3250	3350	3550 (10)	3750	4000 (12) @ 250 kPa	
17.5L-24	lbs.		4400 (6)	4680	5080	5360 (8)	5520	5840	6150 (10)		
	kg		2000 (6)	2120	2300	2430 (8)	2500	2650	2800 (10)		
19.5L-24	lbs.		5200	5680	6000 (8)	6400	6600 (10)	6950	7400	7600 (12) @ 34 psi	
	kg		2360	2575	2725 (8)	2900	3000 (10)	3150	3350	3450 (12) @ 230 kPa	
21L-24	lbs.		6150	6600	6950	7400 (10)	7850	8050	8550 (12)	9900 (16) @ 40 psi	10500 (18) @ 44 psi
	kg		2800	3000	3150	3350 (10)	3550	3650	3875 (12)	4500 (16) @ 280 kPa	4750 (18) @ 300 kPa
21L-28	lbs.		6600	6950 (8)	7400	7850 (10)	8250	8550	8800 (12)	9900 (14) @ 36 psi	
	kg		3000	3150 (8)	3350	3550 (10)	3750	3875	4000 (12)	4500 (14) @ 250 kPa	

NOTES:

- Figures in parentheses denote ply rating for which boldface loads and inflations are maximum.
- Above loads and inflation pressures are transport service.
- For field or other usage, refer to Table E on pages 132-135.
- The load limits shown at right at various speeds apply with no change in inflation pressure.
- For cyclic loading service, see Table F2 on page 138.

MAX. SPEED	% CHANGE IN LOADS	
	REGULAR APPLICATION	CYCLIC* APPLICATION
Stationary	+130%	+130%
2.5 mph (5 km/h)	+45%	+67%
5 mph (10 km/h)	+25%	+50%
10 mph (15 km/h)	+13%	34
15 mph (25 km/h)	+9%	-
20 mph (30 km/h)	+4%	-
25 mph (40 km/h)	Same as Table	-
30 mph (50 km/h)	-9%	-

*Cyclic applications include the normal usages of loader, log stackers, etc. The minimum load must not exceed 60% of the maximum rated tire load.

- Maximum one-way haul distance 500 feet (150 meters).
- Vehicle is operating over unimproved but generally level terrain.
- Consult the rim/wheel manufacturer for confirmation of the strength of the rim/wheel for the intended service.

FOR RIM AND WHEEL LOAD INFORMATION, SEE IMPORTANT NOTES ON PAGES 168-172.

TABLE H – HIGH FLOTATION TIRES USED IN AGRICULTURAL, LOGGING, AND OFF-THE-ROAD SERVICE

TIRE TYPE NOMENCLATURE		MAX SPEED
TRA	TIRE TYPE	SPEED INDEX
		B
HF-1	Shallow Tread	30 mph
HF-2	Regular Lug Tread	30 mph
HF-3	Deep Lug Tread	30 mph
HF-4	Extra Deep Lug Tread	30 mph

TIRE SIZE	INFLATION		LOAD LIMITS AT VARIOUS COLD INFLATION PRESSURES								
	psi		10	15	20	25	30	35	40	45	50
	kPa		80	100	110	120	140	150	170	180	190
42x25.00-20	lbs.		1980	2540	3000	3420	3740 (8)	4180 (10)	4400	4800 (12)	
	kg		900	1150	1360	1500	1700 (8)	1900 (10)	2000	2180 (12)	
48x25.00-20	lbs.		3000	3740	4400 (6)	5080	5680 (8)	6150 (10)	6600	7150 (12)	7600 (14)
	kg		1360	1700	2000 (6)	2300	2575 (8)	2800 (10)	3000	3250 (12)	3450 (14)
800/50-25 (54x31.00-25)	lbs.		3740	4680	5520	6400	7150	7850 (12)			
	kg		1700	2120	2500	2900	3250	3550 (12)			
48x31.00-20	lbs.		3080	3960	4680 (6)	5360 (8)	5840 (10)	6400	6950 (12)	7400 (14)	
	kg		1400	1800	2120 (6)	2430 (8)	2650 (10)	2900	3150 (12)	3350 (14)	
54x37.00-25	lbs.		3960	5080 (6)	6000	6800	7600	8250 (12)		10700 (20) @ 55 psi	
	kg		1800	2300 (6)	2725	3075	3450	3750 (12)		4875 (20) @ 380 kPa	
57x31.00-26	lbs.		4180	5360	6150 (6)						
	kg		1900	2430	2800 (6)						
66x43.00-25	lbs.		5840	7400 (6)	8800 (8)	9900 (10)	11000 (12)	12300 (14)	13200 (16)	13900	14800 (20)
	kg		2650	3350 (6)	4000 (8)	4500 (10)	5000 (12)	5600 (14)	6000 (16)	6300	6700 (20)
66x43.00-26	lbs.		5840	7400 (6)	8800 (8)	9900 (10)	11000 (12)	12000 (14)			
	kg		2650	3350 (6)	4000 (8)	4500 (10)	5000 (12)	5450 (14)			
66x44.00-25	lbs.		6000	7600 (6)	9100	10200 (10)	11400	12800	13600 (16)	14300 (20)	
	kg		2725	3450 (6)	4125	4625 (10)	5150	5800	6150 (16)	6500 (20)	
67x34.00-25	lbs.		5840	7400	8800	10200 (8)	11400 (10)	12300 (12)	13200 (14)		
	kg		2650	3350	4000	4325 (8)	5150 (10)	5600 (12)	6000 (14)		
67x34.00-26	lbs.		5840	7400	8800	9900 (8)	11000 (10)	12000 (12)	13200 (14)		
	kg		2650	3350	4000	4500 (8)	5000 (10)	5450 (12)	6000 (14)		
68x50.00-32	lbs.		5840	7400 (6)	8800 (8)	9900 (12)	11000	12300 (16)		16100 (24) @ 55 psi	
	kg		2650	3350 (6)	4000 (8)	4500 (12)	5000	5600 (16)		7300 (24) @ 380 kPa	
VA73x44.00-32	lbs.		6800	8550	10200	11700	12800 (12)	14300	15200 (16)		
	kg		3075	3875	4625	5300	5800 (12)	6500	6900 (16)		

FOR RIM AND WHEEL LOAD INFORMATION, SEE IMPORTANT NOTES ON PAGES 168-172.



RADIAL FARM

BIAS FARM

FRONTS & IMPLEMENTS

FORESTRY & FLOTATION

DISCONTINUED

LOAD & INFLATION TABLES

GENERAL TIRE INFORMATION

WARRANTY

TABLE H – HIGH FLOTATION TIRES USED IN AGRICULTURAL, LOGGING, AND OFF-THE-ROAD SERVICE

TIRE SIZE	INFLATION		LOAD LIMITS AT VARIOUS COLD INFLATION PRESSURES							
	psi	10	15	20	25	30	35	40	45	50
	kPa	80	100	110	120	140	150	170	180	190
DH73x44.00-32	lbs	6800	8550	10200	11700	12800 (12)	14300	15200 (16)	16500	17600 (20)
	kg	3075	3875	4625	5300	5800 (12)	6500	6900 (16)	7500	8000 (20)
76x50.00-32	lbs	7850	9900	11700	13200	14800	16100 (16)	17600	18700 (20)	
	kg	3550	4500	5300	6000	6700	7300 (16)	8000	8500 (20)	
78x45.00-32	lbs	8050	10200	12000	13600 (10)	15200	16500	18200 (16)		
	kg	3650	4325	5450	6150 (10)	6900	7500	8250 (16)		

FERTILIZER TRUCKS WITH HIGH TORQUE (E.G. WITH INJECTORS)			
CYCLIC EMPTY-TO-FULL PERCENTAGE	MAXIMUM SPEED	CHANGE IN LOADS	CHANGE IN COLD INFLATION PRESSURE
50%	10 mph (15 km/h)	+85%	+5 psi (35 kPa)
50%	15 mph (25 km/h)	+70%	+5 psi (35 kPa)
50%	20 mph (30 km/h)	+50%	+5 psi (35 kPa)
COMBINES & FERTILIZER WITHOUT HIGH TORQUE			
60%	6 mph (10 km/h)	+100%	+5 psi (35 kPa)
60%	10 mph (15 km/h)	+85%	+5 psi (35 kPa)
60%	15 mph (25 km/h)	+70%	+5 psi (35 kPa)
60%	20 mph (30 km/h)	+50%	+5 psi (35 kPa)

MAX. SPEED	% CHANGE IN 30 MPH (50 KM/H) LOADS
Stationary	+165%
*Creep	+100%
5 mph (10 km/h)	+58%
10 mph (15 km/h)	+32%
20 mph (30 km/h)	+12%

*Creep speed is a travel rate of not more than 200 feet (61 meters) in a 30-minute period.

NOTES:

- Figures in parentheses in the first table denote ply rating for which loads and inflation pressures are maximum.
- For operations at other speeds with no change in inflation pressure, inflations above may be changed as shown at right.
- Figures in the chart apply to loads and inflation pressures in Table H. For cyclic loading service see Table F2 on page 138. For cycle loading operations where loads increase or decrease, the empty vehicle load per tire must be less than the percentage of the fully laden tire load shown in the chart above. Maximum load may not be carried for more than 1 mile (1.6 km) before unloading operation begins. This load increase applies to vehicles that operate up to an 11° slope (20% grade).

FOR RIM AND WHEEL LOAD INFORMATION, SEE IMPORTANT NOTES ON PAGES 168-172.

TABLE H1 — HIGH FLOTATION TIRES USED IN LOGGING SERVICE

TIRE TYPE NOMENCLATURE		MAX SPEED
TRA	TIRE TYPE	SPEED INDEX A2
HF-1	Shallow Tread	5 mph
HF-2	Regular Lug Tread	5 mph
HF-3	Deep Lug Tread	5 mph
HF-4	Extra Deep Lug Tread	5 mph

BASIC TIRE LOAD RATINGS FOR TIRE SELECTIONS

TIRE SIZE	INFLATION		LOAD LIMITS AT VARIOUS COLD INFLATION PRESSURES				
	psi	35	40	45	50	55	60
	kPa	240	280	310	340	380	415
54x37.00B25	lbs	13200 (12)				17100 (20)	
	kg	5900 (12)				7700 (20)	
66x43.00-25	lbs	19300 (14)			23400 (20)		
	kg	8800 (14)			10600 (20)		
66x43.00-26	lbs	19000 (14)					
	kg	8650 (14)					
67x34.00B25	lbs		20900 (14)				26800 (22)
	kg		9500 (14)				12150 (22)
67x34.00-26	lbs		20900 (14)				
	kg		9500 (14)				
68x50.00-32	lbs	19400 (16)					
	kg	8800 (16)					
DH73x44.00B32	lbs		24000 (16)		27600 (20)		
	kg		10900 (16)		12500 (20)		
76x50.00B32	lbs	25400 (16)					
	kg	11500 (16)					

NOTES:

- Figures in parentheses denote ply rating for which load and inflation pressures are maximum.

FOR RIM AND WHEEL LOAD INFORMATION, SEE IMPORTANT NOTES ON PAGES 168-172.

TABLE I – DIAGONAL (BIAS) PLY LOG SKIDDER DRIVE WHEEL TIRES USED IN LOGGING OR FORESTRY SERVICE OTHER THAN ON CABLE OR GRAPPLE SKIDDERS

TIRE TYPE NOMENCLATURE		MAX SPEED SPEED INDEX
TRA	TIRE TYPE	A6
LS-2	Intermediate Tread	20 mph
LS-3	Deep Tread	20 mph

BASIC TIRE LOAD RATINGS FOR TIRE SELECTION

TIRE SIZE	INFLATION		LOAD LIMITS AT VARIOUS COLD INFLATION PRESSURES					
	psi		20	25	30	35	40	50
	kPa		140	170	210	240	280	340
16.9-30	lbs		4400	5080	5680 (10)	6150	6600 (14)	
	kg		2000	2300	2575 (10)	2800	3000 (14)	
18.4-26	lbs		4940	5680 (10)	6400 (12)			
	kg		2240	2575 (10)	2900 (12)			
18.4-34	lbs		5680	6400 (10)				
	kg		2575	2900 (10)				
23.1B26	lbs		7150 (10)	8250	9100 (14)	9900 (16)	10700 (20)	
	kg		3250 (10)	3750	4125 (14)	4500 (16)	4875 (20)	
24.5B32	lbs		8800	9900 (12)	11000 (16)	12000 (18)		
	kg		4000	4500 (12)	5000 (16)	5450 (18)		
LOW SECTION HEIGHT								
28LB26	lbs		8250 (12)	9350 (14)	10500 (16)			
	kg		3750 (12)	4250 (14)	4750 (16)			
30.5LB32	lbs		10500 (12)	11700 (16)	13200 (20)	14300	15700 (26)	17600 (32)
	kg		4750 (12)	5300 (16)	6000 (20)	6500	7100 (26)	8000 (32)
35.5LB32	lbs		13900 (16)	16100 (20)	17600 (24)	19300	20900 (30)	
	kg		6300 (16)	7300 (20)	8000 (24)	8750	9500 (30)	

NOTES:

- Figures in parentheses denote ply rating for which boldface loads and inflations are maximum.
- For shipping purposes, tire inflation pressures may be increased to 30 psi (210 kPa). Consult tire manufacturer for minimum tire shipping pressure. This higher inflation pressure must be reduced to operating inflation pressure BEFORE the skidder is removed from the carrier.
- "Tire Load Limit" for log skidders is defined as the maximum load for an individual tire due to the total radial forces imposed on the tire DURING OPERATION. This maximum load includes total vehicle weight with accessories plus load increases caused by log winching or grappelling loads and weight transfers.
- For grapple and cable skidders, refer to Table J on page 147.
- For load and carry type of logging operations such as loaders equipped with log forks and feller-bunchers with maximum speed of 5 mph (10 km/h), above tire load limits may be increased 50% [with 5 psi (35 kPa) increase in inflation pressure]. Maximum length of carry is 500 feet (150 meters).
- When used as duals, tire loads and tangential pull values must be reduced. Multiply figures in table by .88.
- Consult rim and wheel manufacturer for rims for this type of service.
- For transport service and operations that do not require sustained high torque, the load limits shown below at various speeds apply.

MAX. SPEED	% CHANGE IN ABOVE LOADS	CHANGE IN INFL. PRESSURE
Stationary	+170%	+5 psi (35 kPa)
10 mph (15 km/h)	+20%	None
15 mph (25 km/h)	+10%	None
20 mph (30 km/h)	Same As Table	None
25 mph (40 km/h)	-10%	None

FOR RIM AND WHEEL LOAD INFORMATION, SEE IMPORTANT NOTES ON PAGES 168-172.

TABLE J – DIAGONAL (BIAS) PLY LOG SKIDDER DRIVE WHEEL TIRES USED ON CABLE OR GRAPPLE SKIDDERS

TIRE TYPE NOMENCLATURE		MAX. SPEED
		SPEED INDEX
TRA	TIRE TYPE	A2
LS-2	Immediate Tread	5 mph
LS-3	Deep Tread	5 mph

TIRES USED AS SINGLES

BASIC TIRE LOAD RATINGS FOR TIRE SELECTIONS

TIRE SIZE	INFLATION		LOAD LIMITS AT VARIOUS COLD INFLATION PRESSURES				
	psi	25	30	35	40	45	55
	kPa	170	210	240	*275/280	310	380
16.9-30	lbs	6150	7150	8050(10)	8550	9350(14)	
	kg	2800	3250	3650(153)	3875	4250(158)	
18.4-26	lbs	6950	8050(10)	9100(12)			
	kg	3150	3650(153)	4125(157)			
18.4-34	lbs	8050	9100(10)				
	kg	3650	4125(157)				
23.1B26	lbs	9900(10)	11700	12800(14)	13900(16)	15200(20)	
	kg	4500(160)	5300	5800(169)	6300(172)	6900(175)	
24.5B32	lbs	12300	13900(12)	15200(16)	17100(18)		
	kg	5600	6300(172)	6900(175)	7750(179)		
LOW SECTION HEIGHT							
28LB26	lbs	11700(12)	13200(14)	14800(16)	16100(20)		
	kg	5300(166)	6000(170)	6700(174)	7300(177)		
30.5LB32	lbs	14800(12)	16500(16)	18700(20)	19800	22000(26)	24700(32)
	kg	6700(174)	7500(178)	8500(182)	9000	10000(188)	11200(192)
35.5LB32	lbs	19800(16)	22700(20)	24700(24)	26800(26)	29100(30)	
	kg	9000(184)	10300(189)	11200(192)	12150(195)	13200(198)	

* The Tire and Rim Association has adopted an official conversion equivalency for kPa to psi values. The first number reflects the official conversion, and the second number reflects the previous value. Both values are acceptable.

NOTES:

1. Figures in parentheses denote ply rating for which boldface loads and inflations are maximum. Numbers below ply ratings are load index numbers.
2. Above inflation pressure are minimum for loads shown.
3. For shipping purposes, tire inflation pressures may be increased to 30 psi (210 kPa). Inflation pressure must be adjusted to correct operating inflation pressure BEFORE skidder is removed from carrier. Consult tire manufacturer for minimum tire shipping pressure.
4. "Tire Load Limit" for log skidders is defined as the maximum load for an individual tire due to the total radial forces imposed on the tire DURING operation. This maximum load includes total vehicle weight with accessories, plus load increases due to log winching or grappling loads and weight transfer.
5. The above table applies only to log skidder tires used on cable or grapple skidders with a maximum speed of 5 mph (10 km/h). To use on other types of logging or forestry equipment or at speeds greater than 5 mph (10 km/h), refer to Table I on page 146.
6. When used as duals, tire loads must be reduced. Multiply figures in table by .88.
7. Consult rim and wheel manufacturer for rims for this type of service.

FOR RIM AND WHEEL LOAD INFORMATION, SEE IMPORTANT NOTES ON PAGES 168-172.

TABLE K – METRIC FORESTRY TIRES USED IN AGRICULTURAL, LOGGING AND OFF-THE-ROAD SERVICE

RADIAL FARM

BIAS FARM

FRONTS & IMPLEMENTS

FORESTRY & FLOTATION

DISCONTINUED

LOAD & INFLATION TABLES

GENERAL TIRE INFORMATION

WARRANTY

TIRE TYPE NOMENCLATURE		MAX SPEED SPEED INDEX
TRA	TIRE TYPE	A6
HF-1	Shallow Tread	20 mph

LOW TORQUE LOADS – MAXIMUM SPEED: 5 MPH (10 KM/H)

TIRE SIZE	INFLATION		LOAD LIMITS AT VARIOUS COLD INFLATION PRESSURES					
	psi		12	23	35	46	58	73
	kPa		80	160	240	320	400	500
710/45B26.5	lbs		4800	7400	9350	11000	13200	15200 (20)
	kg		2180	3350	4250	5000	6000	6900 (20)

TRANSPORT LOADS – MAXIMUM SPEED: 20 MPH (30 KM/H)

HIGH TORQUE LOADS – MAXIMUM SPEED: 5 MPH (10 KM/H)

TIRE SIZE	INFLATION		LOAD LIMITS AT VARIOUS COLD INFLATION PRESSURES					
	psi		12	23	35	46	58	73
	kPa		80	160	240	320	400	500
710/45B26.5	Lbs		3860	6000	7600	9100	10700	12300 (20)
	kg		1750	2725	3450	4125	4875	5600 (20)

NOTES:

1. Figures in parentheses denote ply rating for which boldface loads and inflations are maximum.

FOR RIM AND WHEEL LOAD INFORMATION, SEE IMPORTANT NOTES ON PAGES 168-172.

TABLE L –

DIAGONAL (BIAS) PLY AGRICULTURAL TRACTOR STEERING WHEEL TIRES USED IN FIELD SERVICE (INCLUDING HILLSIDE COMBINES)

TIRE TYPE NOMENCLATURE		MAX SPEED
TRA	TIRE TYPE	SPEED INDEX
		A8
F-1	Agricultural Single-Rib Tread	25 mph
F-2	Agricultural Multiple-Rib Tread	25 mph
F-3	Industrial Multiple-Rib Tread	25 mph

BASIC TIRE LOAD RATINGS FOR TIRE SELECTION

TIRE SIZE	INFLATION		LOAD LIMITS AT VARIOUS COLD INFLATION PRESSURES										
	psi	24	28	32	36	40	44	48	52	56	60	64	68
	kPa	170	190	220	250	280	300	330	360	390	410	440	470
4.00-9 SL	lbs	287 (2)											
	kg	130 (2)											
4.00-12 SL	lbs	300	330	365	395	420	440	465	495 (4)				
	kg	136	150	165	180	190	200	212	224 (4)				
4.00-15 SL	lbs	355	395	430	465	495	535	565	585 (4)				
	kg	160	180	195	212	224	243	257	265 (4)				
4.00-19 SL	lbs	420	480	520	565	600	640	675	715 (4)				
	kg	190	218	236	257	272	290	307	325 (4)				
4.50-10 SL	lbs						540 (4)						
	kg						245 (4)						
5.00-15 SL	lbs	480	535	585	640	675	715 (4)						
	kg	218	243	265	290	307	325 (4)						
5.50-16 SL	lbs	600	660	715	785	855 (4)	910	935	990	1050 (6)			
	kg	272	300	325	355	387 (4)	412	425	450	475 (6)			
6.00-14 SL	lbs	615	695	740	805	880	935	965	1020 (6)				
	kg	280	315	335	365	400	425	437	462 (6)				
6.00-16 SL	lbs	675	760	825	910 (4)	965	1020	1070	1140 (6)	1200	1230	1280	1360 (8)
	kg	307	345	375	412 (4)	437	462	487	515 (6)	545	560	580	615 (8)
6.50-16 SL	lbs	785	855	935	1020 (4)	1100	1140	1230 (6)					
	kg	355	387	425	462 (4)	500	515	560 (6)					
7.50-16 SL	lbs	990	1100	1200	1320	1390	1480 (6)	1570	1650	1710 (8)			
	kg	450	500	545	600	630	670 (6)	710	750	775 (8)			
7.50/8.00-16 SL	lbs	1070	1200 (4)	1320	1430	1520 (6)	1610	1710	1820 (8)	1870	1980	2040 (10)	
	kg	487	545 (4)	600	650	690 (6)	730	775	825 (8)	850	900	925 (10)	
7.50-18 SL	lbs	1070	1200	1320	1430	1520	1610 (6)			1870 (8)			
	kg	487	545	600	650	690	730 (6)			850 (8)			
7.50-20 SL	lbs	1170	1280	1390 (4)	1520	1610	1710 (6)						
	kg	530	580	630 (4)	690	730	775 (6)						
8.00-16 SL	lbs	1070	1200	1320	1430	1520 (6)	1610	1710	1820	1870	1980	2040 (10)	
	kg	487	545	600	650	690 (6)	730	775	825	850	900	925 (10)	
9.00-10 SL	lbs	990	1100 (4)	1200	1320 (6)	1390	1480	1570 (8)					
	kg	450	500 (4)	545	600 (6)	630	670	710 (8)					
9.50-20 SL	lbs	1650	1870	2040	2200	2340	2470 (8)						
	kg	750	850	925	1000	1060	1120 (8)						
10.00-16 SL	lbs	1570	1760	1930 (6)	2090	2200	2340 (8)		2910 (10)				
	kg	710	800	875 (6)	950	1000	1060 (8)		1320 (10)				

FOR RIM AND WHEEL LOAD INFORMATION, SEE IMPORTANT NOTES ON PAGES 168-172.

TABLE L – DIAGONAL (BIAS) PLY AGRICULTURAL TRACTOR STEERING WHEEL TIRES USED IN FIELD SERVICE (INCLUDING HILLSIDE COMBINES)

BASIC TIRE LOAD RATINGS FOR TIRE SELECTION

TIRE SIZE	INFLATION		LOAD LIMITS AT VARIOUS COLD INFLATION PRESSURES										
	psi	24	28	32	36	40	44	48	52	56	60	64	68
	kPa	170	190	220	250	280	300	330	360	390	410	440	470
4.00-9 SL	lbs	1870	2090	2270 (6)	2470	2600 (8)	2760	2910	3080	3300	3420 (12)	1870	2090
	kg	850	950	1030 (6)	1120	1180 (8)	1250	1320	1400	1500	1550 (12)	850	950
4.00-12 SL	lbs	2400	2680	2910	3200	3420 (8)	3640	3860 (10)	4080	4180	4400 (12)	2400	2680
	kg	1090	1215	1320	1450	1550 (8)	1650	1750 (10)	1850	1900	2000 (12)	1090	1215
LOW SECTION HEIGHT													
7.5L-15 SL	lbs	965	1070	1170	1280	1360	1430 (6)						
	kg	437	487	530	580	615	650 (6)						
9.5L-10 SL	lbs	910	1020 (4)	1100	1200 (6)								
	kg	412	462 (4)	500	545 (6)								
9.5L-15 SL	lbs	1170	1280	1430	1520 (6)	1650	1760	1870 (8)					
	kg	530	580	650	690 (6)	750	800	850 (8)					
11L-15 SL	lbs	1390	1570	1710 (6)	1870	1980	2090 (8)	2200	2340 (10)				
	kg	630	710	775 (6)	850	900	950 (8)	1000	1060 (10)				
11L-16 SL	lbs	1480	1650	1760	1930	2090	2200 (8)	2340	2470 (10)	2540	2680	2760 (12)	
	kg	670	750	800	875	950	1000 (8)	1060	1120 (10)	1150	1215	1250 (12)	
14L-16.1 SL	lbs	2270	2540 (6)	2830	3000 (8)	3200	3420 (10)	3640	3860 (12)				
	kg	1030	1150 (6)	1285	1360 (8)	1450	1550 (10)	1650	1750 (12)				
16.5L-16.1 SL	lbs	2910	3200	3520 (8)	3860	4080 (10)							
	kg	1320	1450	1600 (8)	1750	1850 (10)							

NOTES:

- Figures in parentheses denote ply rating for which boldface loads and inflations are maximum.
- Maximum shipping pressures are the maximum inflation pressures for the tire sizes and ply ratings shown.
- For above tires used in cyclic loading service (excluding hillside combines) with speeds up to 6 mph (10 km/h), above loads may be increased 67%. This load increase applies to vehicles that operate on slopes above 11° (20% grade).
- Load limits at various speeds with no change in inflation pressure appear at right.

MAX. SPEED	% CHANGE IN LOADS IN ABOVE TABLE
Stationary	+200%
10 mph (15 km/h)	+50% (except hillside combines)
15 mph (25 km/h)	+28% (except hillside combines)
20 mph (30 km/h)	+11%
25 mph (40 km/h)	Same as Table
30 mph (50 km/h)	-9% (F-3 tires only)

FOR RIM AND WHEEL LOAD INFORMATION, SEE IMPORTANT NOTES ON PAGES 168-172.

TABLE M — DIAGONAL (BIAS) PLY AGRICULTURAL IMPLEMENT TIRES

TIRE TYPE NOMENCLATURE		MAX SPEED SPEED INDEX
TRA	TIRE TYPE	B
I-1	Rib Tread	30 mph
I-2	Moderate Traction	30 mph
I-3	Traction Tread	30 mph
I-4	Smooth Tread	30 mph

BASIC TIRE LOAD RATINGS FOR TIRE SELECTION

TIRE SIZE	INFLATION		LOAD LIMITS AT VARIOUS COLD INFLATION PRESSURES								
	psi	24	28	32	36	40	44	48	52	56	60
	kPa	170	190	220	250	280	300	330	360	390	410
4.00-9 SL	lbs	365	410	440	480	520	550 (4)				
	kg	165	185	200	218	236	250 (4)				
4.00-12 SL	lbs	440	495	535	585	640	675 (4)				
	kg	200	224	243	265	290	307 (4)				
4.00-15 SL	lbs	535	585	640	695	740	785 (4)				
	kg	243	265	290	315	335	355 (4)				
4.00-18 SL	lbs	585 (2)	660	715	785	825	880 (4)				
	kg	265 (2)	300	325	355	375	400 (4)				
5.00-15 SL	lbs	715	805	880	965 (4)						
	kg	325	365	400	437 (4)						
5.50-16 SL	lbs	910	990	1100	1170 (4)						
	kg	412	450	500	530 (4)						
5.90-15 SL	lbs	855	935	1050	1140 (4)						
	kg	387	425	475	515 (4)						
6.00-16 SL	lbs	1020	1140	1230 (4)	1360	1430	1520 (6)				
	kg	462	515	560 (4)	615	650	690 (6)				
6.40-15 SL	lbs	965	1070	1170 (4)	1280	1360	1430	1520 (6)			
	kg	437	487	530 (4)	580	615	650	690 (6)			
6.50-16 SL	lbs	1140	1280	1390	1520	1610	1710 (6)				
	kg	515	580	630	690	730	775 (6)				
6.70-15 SL	lbs	1070	1170	1280 (4)	1390	1520	1610 (6)				
	kg	487	530	580 (4)	630	690	730 (6)				
7.50-10 SL	lbs	1100	1230	1360	1480 (6)						
	kg	500	560	615	670 (6)						
7.50-14 SL	lbs	1230	1360 (4)								
	kg	560	615 (4)								
7.50-16 SL	lbs	1480	1650 (4)	1820	1930	2090	2200	2340	2470	2600	2680 (10)
	kg	670	750 (4)	825	872	950	1000	1060	1120	1180	1215 (10)
7.50-18 SL	lbs	1520	1710	1870	2040 (6)						
	kg	690	775	850	925 (6)						
7.50-20 SL	lbs	1610	1760 (4)	1930	2090 (6)						
	kg	730	800 (4)	875	950 (6)						
7.50-24 SL	lbs	1650	1870 (4)	2040	2200 (6)						
	kg	750	850 (4)	925	1000 (6)						

FOR RIM AND WHEEL LOAD INFORMATION, SEE IMPORTANT NOTES ON PAGES 168-172.

TABLE M – DIAGONAL (BIAS) PLY AGRICULTURAL IMPLEMENT TIRES

BASIC TIRE LOAD RATINGS FOR TIRE SELECTION

TIRE SIZE	INFLATION		LOAD LIMITS AT VARIOUS COLD INFLATION PRESSURES								
	psi	24	28	32	36	40	44	48	52	56	60
	kPa	170	190	220	250	280	300	330	360	390	410
7.60-15 SL	lbs	1230	1390 (4)	1520	1650	1760 (6)	1870	1980	2090 (8)		
	kg	560	630 (4)	690	750	800 (6)	850	900	950 (8)		
9.00-10 SL	lbs	1480 (4)	1650	1820	1980	2090	2200	2340	2470 (10)		
	kg	670 (4)	750	825	900	950	1000	1060	1120 (10)		
9.00-16 SL	lbs	1980	2200	2400	2600	2760	2910 (8)	3080	3300 (10)		
	kg	900	1000	1090	1180	1250	1320 (8)	1400	1500 (10)		
9.00-24 SL	lbs	2540	2830 (6)	3080	3300	3520 (8)					
	kg	1150	1285 (6)	1400	1500	1600 (8)					
10.00-15 SL	lbs	2270	2540	2760	3000	3200 (8)	3420	3640 (10)	3740	3960 (12)	
	kg	1030	1150	1250	1360	1450 (8)	1550	1650 (10)	1700	1800 (12)	
11.25-20 SL	lbs	3200	3520	3960	4180	4540	4800	5080	5360	5680 (14)	
	kg	1450	1600	1800	1900	2060	2180	2300	2430	2575 (14)	
11.25-24 SL	lbs	3300	3640	4080 (8)	4300	4680 (10)	4940	5200 (12)			
	kg	1500	1650	1850 (8)	1950	2120 (10)	2240	2360 (12)			
11.25-28 SL	lbs	3420	3860	4180	4540	4800	5080	5360 (12)			
	kg	1550	1750	1900	2060	2180	2300	2430 (12)			
13.50-16.1 SL	lbs	3520 (6)	3860	4300 (8)	4680	4940 (10)	5200 (12)				
	kg	1600 (6)	1750	1950 (8)	2120	2240 (10)	2360 (12)				

NOTES:

1. Figures in parentheses denote ply rating for which boldface loads and inflations are maximum.
2. Maximum shipping pressures are the maximum inflation pressures for the tire sizes and ply ratings shown.
3. For speeds not exceeding 10 mph (15 km/h), above loads may be increased 15%.
4. For stationary service, above loads may be increased by 100% with no increase in inflation pressure.

FOR RIM AND WHEEL LOAD INFORMATION, SEE IMPORTANT NOTES ON PAGES 168-172.

TABLE N – DIAGONAL (BIAS) PLY LOW SECTION HEIGHT IMPLEMENT TIRES

TIRE TYPE NOMENCLATURE		MAX SPEED
TRA	TIRE TYPE	SPEED INDEX B
I-1	Rib Tread	30 mph
I-2	Moderate Traction	30 mph
I-3	Traction Tread	30 mph
I-4	Smooth Tread	30 mph

BASIC TIRE LOAD RATINGS FOR TIRE SELECTION

TIRE SIZE	INFLATION		LOAD LIMITS AT VARIOUS COLD INFLATION PRESSURES								
	psi	24	28	32	36	40	44	48	52	56	
	kPa	170	190	220	250	280	300	330	360	390	
8.5L-14 SL	lbs	1390	1570	1710	1870 (6)						
	kg	630	710	775	850 (6)						
9.5L-14 SL	lbs	1570 (4)	1760	1930 (6)	2090	2200	2400 (8)				
	kg	710 (4)	800	875 (6)	950	1000	1090 (8)				
9.5L-15 SL	lbs	1650	1820	2040 (6)	2200	2340	2470 (8)	2600	2760	2910	3200 (12) @ 64 psi
	kg	750	825	925 (6)	1000	1060	1120 (8)	1180	1250	1320	1450 (12) @ 440 (kPa)
11L-14 SL	lbs	1870	2040 (6)		2470 (8)						
	kg	850	925 (6)		1120 (8)						
11L-15 SL	lbs	1930	2150 (6)	2340	2540 (8)	2760	2910 (10)	3080	3200 (12)		
	kg	875	975 (6)	1060	1150 (8)	1250	1320 (10)	1400	1450 (12)		
11L-16 SL	lbs	2040	2270 (6)	2470	2680 (8)	2830	3000 (10)				
	kg	925	1030 (6)	1120	1215 (8)	1285	1360 (10)				
12.5L-15 SL	lbs	2270	2540 (6)	2760	3000 (8)	3200	3420 (10)	3640	3860 (12)		4680 (18) @ 72 psi
	kg	1030	1150 (6)	1250	1360 (8)	1450	1550 (10)	1650	1750 (12)		2120 (18) @ 490 kPa
12.5L-16 SL	lbs	2400	2680	2910	3080 (8)	3300	3520	3740	3960 (12)	4180 (14)	
	kg	1090	1215	1320	1400 (8)	1500	1600	1700	1800 (12)	1900 (14)	
14L-16.1 SL	lbs	3200 (6)	3520	3860 (8)	4180 (10)	4400	4680 (12)	4940	5200 (14)		
	kg	1450 (6)	1600	1750 (8)	1900 (10)	2000	2120 (12)	2240	2360 (14)		
16.5L-16.1 SL	lbs	3960 (6)	4400 (8)	4800	5200 (10)	5680 (12)	6000	6400 (14)			
	kg	1800 (6)	2000 (8)	2180	2360 (10)	2575 (12)	2725	2900 (14)			
19L-16.1 SL	lbs	4940	5520	6000 (10)	6600 (12)						
	kg	2240	2500	2725 (10)	3000 (12)						
21.5L-16.1 SL	lbs	6000 (8)	6600 (10)	7150 (12)	7850 (14)						
	kg	2725 (8)	3000 (10)	3250 (12)	3550 (14)						

TIRE SIZE	INFLATION		LOAD LIMITS AT VARIOUS COLD INFLATION PRESSURES								
	psi	35	38								
	kPa	240	260								
600/55-22.5	lbs										
	kg										
700/50-22.5	lbs				11700(16)						
	kg				5310 (16)						

NOTES:

1. Figures in parentheses denote ply rating for which boldface loads and inflations are maximum.
2. Maximum shipping pressures are the maximum inflation pressures for the tire sizes and ply ratings shown.
3. For speeds not exceeding 10 mph (15 km/h), loads in the table may be increased 15%.
4. For stationary service, loads in the table may be increased by 100% with no increase in inflation pressure.

FOR RIM AND WHEEL LOAD INFORMATION, SEE IMPORTANT NOTES ON PAGES 168-172.

TABLE O – FARM IMPLEMENT HIGHWAY SPECIAL (F1) TIRES FOR TOWED HIGHWAY AND AGRICULTURAL SERVICE

BASIC TIRE LOAD RATINGS FOR TIRE SELECTION MAXIMUM SPEED 62 MPH (100 KM/H)

TIRE SIZE	INFLATION		LOAD LIMITS AT VARIOUS COLD INFLATION PRESSURES														
	psi		20	25	30	35	40	45	50	55	60	65	70	75	80	85	90
	kPa		140	170	210	240	280	310	340	380	410	450	480	520	550	590	620
9.5L-15FI	lbs		1390	1610	1760 (B)	1930	2090	2270 (C)	2400	2540	2680 (D)	2830	2910	3080 (E)			
	kg		630	730	800 (B)	875	950	1030 (C)	1090	1150	1215 (D)	1285	1320	1400 (E)			
11L-15FI	lbs		1650	1870	2080 (B)	2270	2470	2600 (C)	2830	3000	3080 (D)	3300	3420	3520	3650	3800	3960 (F)
	kg		750	850	950 (B)	1030	1120	1180 (C)	1285	1360	1400 (D)	1500	1550	1600	1660	1720	1800 (F)
12.5L-15FI	lbs		1930	2200	2470 (B)	2680	2910	3080 (C)	3300	3520	3740 (D)	3860	4080	4180	4340	4500	4680 (F)
	kg		875	1000	1120 (B)	1215	1320	1400 (C)	1500	1600	1700 (D)	1750	1850	1900	1970	2040	2120 (F)

NOTES:

1. This load and inflation table is for FI tires only.
2. Letters in parentheses denote load range for which boldface loads and inflations are maximum.
3. For service at maximum speed of 30 mph (50 km/h) and below, loads may be increased by 20% with no change to the inflation pressure.

RADIAL FARM

BIAS FARM

FRONTS & IMPLEMENTS

FORESTRY & FLOTATION

DISCONTINUED

LOAD & INFLATION TABLES

GENERAL TIRE INFORMATION

WARRANTY

FOR RIM AND WHEEL LOAD INFORMATION, SEE IMPORTANT NOTES ON PAGES 168-172.

TABLE P – IRRIGATION TIRES AT CREEP SPEED*

BASIC TIRE LOAD RATINGS FOR TIRE SELECTION

TIRE SIZE	INFLATION		LOAD LIMITS AT VARIOUS COLD INFLATION PRESSURES					
	psi	18	21	22	24	26	31	34
	kPa	120	145	150	170	180	215	235
11.2-24 (4 Ply)	lbs			3480				
	kg			1580				
11.2-24 (6 Ply)	lbs							4410
	kg							2000
14.9-24 (4 Ply)	lbs	5060						
	kg	2295						
14.9-24 (6 Ply)	lbs					6330		
	kg					2870		
16.9-24 (6 Ply)	lbs				7220			
	kg				3275			
16.9-24 (8 Ply)	lbs						8610	
	kg						3905	
18.4-26 (6 Ply)	lbs		8360					
	kg		3790					
11.2-38 (4 Ply)	lbs				4400			
	kg				2000			
12.4-38 (4 Ply)	lbs		4935					
	kg		2240					
290/85D38 132 Load Index	lbs				4400			
	kg				2000			
380/85D24 145 Load Index	lbs					6400		
	kg					2900		

*Creep speed is a travel rate of not more than 200 feet (61 meters) in a 30-minute period.

FOR RIM AND WHEEL LOAD INFORMATION, SEE IMPORTANT NOTES ON PAGES 168-172.

TABLE Q – SPECIAL APPLICATION I-3 IMPLEMENT TIRES – ALL TRACTION UTILITY

BASIC TIRE LOAD RATINGS FOR TIRE SELECTION

TIRE SIZE	PLY RATING	SPEED	psi kPa	36 250	40 280	44 300	45 310	50 350	52 360	54 375
12.0/12.5-18	12	0 mph*	lbs					12200		
		0 km/h	kg					5535		
		5 mph**	lbs					7960		
		10 km/h	kg					3610		
		25 mph	lbs					5300		
		40 km/h	kg					2405		
		30 mph	lbs					4820		
		50 km/h	kg					2185		
10/10.5-20	10	0 mph*	lbs							11230
		0 km/h	kg							5095
		5 mph**	lbs							7330
		10 km/h	kg							3325
		25 mph	lbs							4880
		40 km/h	kg							2215
		30 mph	lbs							4440
		50 km/h	kg							2015

*Stationary

**Cyclic application (one-way distance 2,000 feet/600 meters)

RADIAL FARM

BIAS FARM

FRONTS &
IMPLEMENTS

FORESTRY &
FLOTATION

DISCONTINUED

LOAD & INFLATION
TABLES

GENERAL TIRE
INFORMATION

WARRANTY

FOR RIM AND WHEEL LOAD INFORMATION, SEE IMPORTANT NOTES ON PAGES 168-172.

TABLE R – DUPLEX FARM TIRES

BASIC TIRE LOAD RATINGS FOR TIRE SELECTION MAXIMUM SPEED 30 MPH (50 KM/H)

TIRE SIZE	INFLATION		LOAD LIMITS AT VARIOUS COLD INFLATION PRESSURES									
	psi	25	30	35	40	45	50	55	60	65	70	75
	kPa	170	210	240	280	310	340	380	410	450	480	520
36x16B17.5 NHS / 36x16-17.5 NHS	lbs	2910	3420	3960	4400 (8)	4800	5200	5520 (10)	5840	6150	6600	6950 (14)
	kg	1320	1550	1800	2000 (8)	2180	2360	2500 (10)	2650	2800	3000	3150 (14)
40x19B19.5 NHS	lbs	3640	4400	4940	5520	6000	6600 (12)	6950	7400	7850 (14)		
	kg	1650	2000	2240	2500	2725	3000 (12)	3150	3350	3550 (14)		

NOTES:

1. Figures in parentheses denote ply rating for which boldface loads and inflations are maximum.
2. Maximum shipping pressures are the maximum inflation pressures for the tire sizes and ply ratings shown.
3. For speeds not exceeding 10 mph (15 km/h), loads may be increased 15%.
4. For stationary service, loads may be increased by 100% with no increase in inflation pressure.

FOR RIM AND WHEEL LOAD INFORMATION, SEE IMPORTANT NOTES ON PAGES 168-172.

TABLE S — TIRES USED IN SKID STEER/MINI-LOADER AERIAL LIFT SERVICE

BASIC TIRE LOAD RATINGS FOR TIRE SELECTION MAXIMUM SPEED 5 MPH (10 KM/H)

TIRE SIZE	INFLATION		LOAD LIMITS AT VARIOUS COLD INFLATION PRESSURES									
	Psi	30	35	40	45	50	55	60	65	70	75	80
	kPa	210	240	280	310	340	380	410	450	480	520	550
10-16.5 NHS (265/70D16.5)	lbs	2760 (4)	3020	3260	3500 (6)	3720	3930	4140 (8)	4340	4710 (10)		
	kg	1250 (4)	1370	1480	1590 (6)	1685	1785	1880 (8)	1970	2135 (10)		
12-16.5 NHS (305/70D16.5)	lbs	3560	3900	4220 (6)	4520	4810 (8)	5080	5340	5600 (10)			6320 (12)
	kg	1615	1770	1915 (6)	2050	2180 (8)	2305	2420	2540 (10)			2865 (12)
33x15.50-16.5 (395/55D16.5)	lbs	4555 (6)	4985	5395 (8)	5775	6145 (10)	6495	6835 (12)				
	kg	2065 (6)	2260	2445 (8)	2620	2785 (10)	2945	3100 (12)				
14-17.5 NHS (355/70D17.5)	lbs	4820 (6)	5260	5700 (8)	6100	6500	6850 (10)	7220	7560 (12)			8550 (14)
	kg	2185 (6)	2385	2585 (8)	2765	2950	3105 (10)	3275	3430 (12)			3880 (14)
15-19.5 NHS (385/65D19.5)	lbs	6130 (6)	6710	7250 (8)	7770	8260	8740	9190 (12)	9630	10060(14)		10880(16)
	kg	2780 (6)	3045	3290 (8)	3525	3745	3965	4170 (12)	4370	4565 (14)		4935 (16)

NOTES:

- Figures in parentheses denote ply rating for which boldface loads and inflations are maximum.
- Load limits at various speeds with no change in inflation pressures are as follows:

MAX. SPEED	% CHANGE IN LOADS IN ABOVE TABLE
Stationary	+58%
5 mph (10 km/h)	No Change
10 mph (15 km/h)	-21%
12.5 mph (20 km/h)	-24%
20 mph (30 km/h)	-32%
25 mph (40 km/h)	-34%
30 mph (50 km/h)	-37%

FOR RIM AND WHEEL LOAD INFORMATION, SEE IMPORTANT NOTES ON PAGES 168-172.

TABLE S1 – SMALLER-SIZE HIGH FLOTATION TIRES FOR AGRICULTURAL AND SKID STEER/MINI-LOADER SERVICE

TIRE TYPE NOMENCLATURE		MAX SPEED
TRA	TIRE TYPE	SPEED INDEX B
HF-1	Shallow Tread	30 mph
HF-2	Regular Lug Tread	30 mph
HF-3	Deep Lug Tread	30 mph

BASIC TIRE LOAD RATINGS FOR TIRE SELECTION

TIRE SIZE	INFLATION		LOAD LIMITS AT VARIOUS COLD INFLATION PRESSURES								
	psi	20	25	30	35	40	45	50	55	60	
	kPa	140	170	210	240	280	310	340	380	410	
27x8.50-15 NHS (215/70D15)	lbs	965	1100	1230 (4)	1320	1430	1570 (6)	1650	1760	1820 (8)	
	kg	437	500	560 (4)	600	650	710 (6)	750	800	825 (8)	
27x9.50-15 NHS	lbs	990	1140	1280 (4)	1390	1480	1610 (6)	1710	1820	1870 (8)	
	kg	450	515	580 (4)	630	670	730 (6)	775	825	850 (8)	
27x10.50-15 NHS (260/65D15)	lbs	1020	1170	1320	1430	1520	1650 (6)	1760	1870	1970 (8)	
	kg	460	530	600	650	690	750 (6)	800	850	895 (8)	
29x12.00-15 NH	lbs	1320 (4)		1710 (6)							
	kg	600 (4)		775 (6)							
31x13.50-15 NHS	lbs	1650 (4)	1870	2090 (6)	2270	2470	2600 (8)	2760	2910	3080 (10)	3520 lbs. @ 75 psi (12)
	kg	750 (4)	850	950 (6)	1030	1120	1180 (8)	1250	1320	1400 (10)	1600 kg @ 520 kPa (12)
31x15.50 NHS (390/60D15)	lbs	1710 (4)	1930	2105 (6)	2340	2540	2760 (8)				
	kg	775 (4)	875	975 (6)	1060	1150	1250 (8)				

NOTES:

- Figures in parentheses denote ply rating for which boldface loads and inflations are maximum.
- For operations at other speeds, including skid steer/mini-loader service, the loads in the table may be changed as shown below with no change in inflation pressure:

MAX. SPEED	% CHANGE IN LOADS IN ABOVE TABLE
Stationary	+58%
5 mph (10 km/h)	No Change
10 mph (15 km/h)	-21%
12.5 mph (0 km/h)	-24%
30 mph (50 km/h)	-37%

* Creep speed is a travel speed of not more than 200 feet (61 meters) in a 30-minute period.

FOR RIM AND WHEEL LOAD INFORMATION, SEE IMPORTANT NOTES ON PAGES 168-172.

TABLE S2 – TIRES USED IN AERIAL LIFT APPLICATIONS

BASIC TIRE LOAD RATINGS FOR TIRE SELECTION

TIRE SIZE	LOAD LIMITS AT VARIOUS COLD INFLATION PRESSURES							
	SPEED	70	75	80	85	90	95	100
355/70D17.5 NHS (14-17.5 NHS)	Static	9900 (10)	10200	10700	11000 (12)	11700	12000	12300 (14)
	5 mph (10 km/h)	6950 (10)	7400	7600	7850 (12)	8250	8550	8800 (14)
	10 mph (15 km/h)	6000 (10)	6400	6600	6800 (12)	7150	7400	7600 (14)
	20 mph (30 km/h)	5680 (10)	5840	6150	6400 (12)	6600	6950	7150 (14)
	25 mph (40 km/h)	5360 (10)	5680	6000	6150 (12)	6400	6600	6800 (14)
	30 mph (50 km/h)	5200 (10)	5520	5680	6000 (12)	6150	6400	6600 (14)
385/65D19.5 NHS (15-19.5 NHS)	Static	11400 (12)	12000	12800	13200 (14)	13600	14300	14800 (16)
	5 mph (10 km/h)	8800 (12)	9350	9650	10200 (14)	10500	11000	11400 (16)
	10 mph (15 km/h)	7600 (12)	8050	8250	8800 (14)	9100	9350	9650 (16)
	20 mph (30 km/h)	7150 (12)	7600	7850	8250 (14)	8550	8800	9100 (16)
	25 mph (40 km/h)	6950 (12)	7150	7600	7850 (14)	8250	8550	8800 (16)
	30 mph (50 km/h)	6800 (12)	6950	7400	7600 (14)	8050	8250	8550 (16)
385/65D22.5 NHS (15-22.5 NHS)	Static	12800 (12)	13200	13900	14300 (14)	14800	15700	16100 (16)
	5 mph (10 km/h)	9650 (12)	10200	10700	11000 (14)	11400	12000	12300 (16)
	10 mph (15 km/h)	8550 (12)	8800	9100	9650 (14)	9900	10200	10700 (16)
	20 mph (30 km/h)	7850 (12)	8250	8550	9100 (14)	9350	9650	9900 (16)
	25 mph (40 km/h)	7600 (12)	7850	8250	8550 (14)	9100	9350	9650 (16)
	30 mph (50 km/h)	7400 (12)	7600	8050	8250 (14)	8800	9100	9350 (16)
445/65D19.5 NHS (18-19.5 NHS)	Static	15200	15700	16500	17100 (16)	17600	18700	19300 (18)
	5 mph (10 km/h)	11400	12000	12800	13200 (16)	13600	14300	14800 (18)
	10 mph (15 km/h)	9900	10500	11000	11400 (16)	11700	12300	12800 (18)
	20 mph (30 km/h)	9350	9650	10200	10500 (16)	11000	11400	11700 (18)
	25 mph (40 km/h)	8800	9350	9900	10200 (16)	10500	11000	11400 (18)
	30 mph (50 km/h)	8600	9100	9600	10000 (16)	10300	10800	11200 (18)
445/65D22.5 NHS (18-22.5 NHS)	Static	16500	17100	17600	18700 (16)	19300	19800	20900 (18)
	5 mph (10 km/h)	12800	13200	13600	14300 (16)	14800	15200	16100 (18)
	10 mph (15 km/h)	10700	11400	11700	12300 (16)	12800	13200	13600 (18)
	20 mph (30 km/h)	10200	10700	11000	11400 (16)	12000	12300	12800 (18)
	25 mph (40 km/h)	9650	10200	10700	11000 (16)	11400	12000	12300 (18)
	30 mph (50 km/h)	9350	9900	10500	10700 (16)	11400	11700	12000 (18)

NOTES:

1. For 265/70D16.5 NHS (10-16.5 NHS) and 305/70D16.5 NHS (12-16.5 NHS) sizes used in aerial lift applications, see Table S Skid-Steer/Mini-Loader on page 217 for loads and inflation pressures.
2. Figures in parentheses denote ply rating for which boldface loads and inflations are maximum.
3. Tires for aerial lift applications feature a stronger bead construction for the higher inflation pressure required.
4. For 14-17.5 NHS and 15-19.5 NHS Super Traction Duplex tires used in aerial lift applications, see Table S Skid-Steer/Mini-Loader on page 158 for loads and inflation pressures.

FOR RIM AND WHEEL LOAD INFORMATION, SEE IMPORTANT NOTES ON PAGES 168-172.

TABLE T — AGRICULTURAL TRACTOR DRIVE WHEEL TIRES FOR SMALL TRACTORS

BASIC TIRE LOAD RATINGS FOR TIRE SELECTION MAXIMUM SPEED 20 MPH (30 KM/H)

TIRE SIZE	INFLATION		LOAD LIMITS AT VARIOUS COLD INFLATION PRESSURES											
	psi	12	14	16	18	20	22	24	26	28	30	32	34	36
	kPa	80	100	110	120	140	150	160	180	190	210	220	230	250
5-12	lbs	265	290	310 (2)	340	355	375	395	420	440	455	465	495 (4)	
	kg	121	132	140 (2)	155	160	170	180	190	200	206	212	224 (4)	
180/85D12	lbs							715(69A6)						
	kg							325(69A6)						
5-14	lbs												550 (4)	
	kg												250 (4)	
6-12	lbs	365	395 (2)	430	455	495	520	550	565	600 (4)				
	kg	165	180 (2)	195	206	224	236	250	257	272 (4)				
6-14	lbs	410	440 (2)	480	505	550	565	600	640	660 (4)				
	kg	185	200 (2)	218	230	250	257	272	290	300 (4)				
6-16	lbs	440	480	520	565	600	640	660	695	740 (4)				
	kg	200	218	236	257	272	290	300	315	335 (4)				
6.00-16	lbs	560 (2)	615	665	710	755	800	840	880 (4)					
	kg	250 (2)	280	300	320	340	360	380	400 (4)					
7-14	lbs	520 (2)	565	615	660	715	740	785 (4)						
	kg	236 (2)	257	280	300	325	335	355 (4)						
7-16	lbs	585 (2)	640	675	740	785	825	855 (4)	910	935	990	1020	1050	1100 (6)
	kg	265 (2)	290	307	335	355	375	387 (4)	412	425	450	462	475	500 (6)
8-16	lbs	825	910	990	1070 (4)	1140	1200	1230	1320	1360 (6)				
	kg	375	412	450	487 (4)	515	545	560	600	615 (6)				
8-18	lbs	910	990	1070	1140 (4)	1230	1280	1360	1430	1480 (6)				
	kg	412	450	487	515 (4)	560	580	615	650	670 (6)				
8.0/75-15	lbs													1760 (6)
	kg													800 (6)

NOTES:

1. Figures in parentheses denote ply rating for which boldface loads and inflations are maximum.
2. Load limits at various cold inflation pressures are shown at right.

MAX. SPEED	% CHANGE IN LOADS IN ABOVE TABLE
Stationary	+130%
3 mph (5 km/h)	+70%
5 mph (10 km/h)	+40%
10 mph (15 km/h)	+30%
12 mph (20 km/h)	+20%
15 mph (25 km/h)	+7%
20 mph (30 km/h)	None

FOR RIM AND WHEEL LOAD INFORMATION, SEE IMPORTANT NOTES ON PAGES 168-172.

TABLE U – TIRES FOR UTILITY VEHICLES AND LAWN AND GARDEN TRACTORS

BASIC TIRE LOAD RATINGS FOR TIRE SELECTIONS MAXIMUM SPEED 10 MPH (15 KM/H)

TIRE SIZE	INFLATION		LOAD LIMITS AT VARIOUS COLD INFLATION PRESSURES								
	psi		8	10	12	14	16	18	20	22	24
	kPa		55	70	80	100	110	120	140	150	170
20x8.00-10 NHS	lbs		470	535	595 (2)	655	705	755	805	850	895 (4)
	kg		210	245	270 (2)	300	320	340	370	390	410 (4)
21x8.00-10 NHS	lbs		510	585	650 (2)	710	770	825	875	925	975 (4)
	kg		230	265	295 (2)	320	350	375	395	420	440 (4)
23x8.50-12 NHS	lbs		620	705 (2)	785	860	930	995	1060	1120 (4)	
	kg		280	320 (2)	355	390	420	450	480	510 (4)	
24x8.50-14 NHS	lbs										1080 (4)
	kg										490 (4)
25x8.50-14 NHS	lbs		730	830 (2)	925	1010	1100	1170	1250	1320 (4)	1640 (6) @ 32 psi
	kg		330	375 (2)	420	460	495	535	565	600 (4)	745 (6) @ 220 kPa
23x10.50-12 NHS	lbs		785	890 (2)	990	1085	1175	1260	1340 (4)		
	kg		355	405 (2)	450	490	535	570	610 (4)		
26x12.00-12 NHS	lbs		1040	1185 (2)	1320	1445	1560	1670	1780 (4)		2745 (8) @ 42 psi
	kg		470	540 (2)	600	660	710	760	810 (4)		1250 (8) @ 290 kPa

NOTES:

1. Figures in parentheses denote ply rating for which boldface loads and inflations are maximum.
2. For 30 mph (50 km/h) service for tires with rim diameter codes of 10 and larger, the loads must be reduced by 20% at the same inflation pressure.

RADIAL FARM

BIAS FARM

FRONTS & IMPLEMENTS

FORESTRY & FLOTATION

DISCONTINUED

LOAD & INFLATION TABLES

GENERAL TIRE INFORMATION

WARRANTY

FOR RIM AND WHEEL LOAD INFORMATION, SEE IMPORTANT NOTES ON PAGES 168-172.

TABLE V — SPECIAL APPLICATION I-3 IMPLEMENT TIRES – SUPER TRACTION LOADER

BASIC TIRE LOAD RATINGS FOR TIRE SELECTION

TIRE SIZE	PLY RATING	SPEED	psi	36	40	44	45	50	52	54
			kPa	250	280	300	310	350	360	375
12.5-18	10	0 mph*	lbs			11230				
		0 km/h	kg			5095				
		5 mph**	lbs			7330				
		10 km/h	kg			3325				
		25 mph	lbs			4880				
		40 km/h	kg			2215				
		30 mph	lbs			4440				
50 km/h	kg			2015						

*Stationary

**Cyclic application (one-way distance 2,000 feet/600 meters)

NOTES:

1. Figures in parentheses denote ply rating for which boldface loads and inflations are maximum.
2. Maximum shipping pressures are the maximum inflation pressures for the tire sizes and ply ratings shown.
3. For speeds not exceeding 10 mph (15 km/h), loads in the table may be increased 15%.
4. For stationary service, loads in the table may be increased by 100% with no increase in inflation pressure.

FOR RIM AND WHEEL LOAD INFORMATION, SEE IMPORTANT NOTES ON PAGES 168-172.

INTERNATIONAL LOAD INDEX NUMBERS

KILOGRAM LOADS AND TRA EQUIVALENT POUND LOADS
(NOT APPLICABLE TO PASSENGER CAR OR TRUCK-BUS TIRES)

LI	kg	lbs	LI	kg	lbs	LI	kg	lbs	LI	kg	lbs
50	190	420	90	630	1320	130	1930	4180	170	6000	13200
51	195	430	91	615	1360	131	1950	4300	171	6150	13600
52	200	440	92	630	1390	132	2000	4400	172	6300	13900
53	206	455	93	650	1430	133	2060	4540	173	6500	14300
54	212	465	94	670	1480	134	2120	4680	174	6700	14800
55	218	480	95	690	1520	135	2180	4800	175	6900	15200
56	224	495	96	710	1570	136	2240	4940	176	7100	15700
57	230	505	97	730	1610	137	2300	5080	177	7300	16100
58	236	520	98	750	1650	138	2360	5200	178	7500	16500
59	243	535	99	775	1710	139	2430	5360	179	7750	17100
60	250	550	100	800	1760	140	2500	5520	180	8000	17600
61	257	565	101	825	1820	141	2575	5680	181	8250	18200
62	265	585	102	850	1870	142	2650	5840	182	8500	18700
63	272	600	103	875	1930	143	2725	6000	183	8750	19300
64	280	615	104	900	1980	144	2800	6150	184	9000	19800
65	290	640	105	925	2040	145	2900	6400	185	9250	20400
66	300	660	106	950	2090	146	3000	6600	186	9500	20900
67	307	675	107	975	2150	147	3075	6800	187	9750	21500
68	315	695	108	1000	2200	148	3150	6950	188	10000	22000
69	325	715	109	1030	2270	149	3250	7150	189	10300	22700
70	335	740	110	1060	2340	150	3350	7400	190	10600	23400
71	345	760	111	1090	2400	151	3450	7600	191	10900	24000
72	355	785	112	1120	2470	152	3550	7850	192	11200	24700
73	365	805	113	1150	2540	153	3650	8050	193	11500	25400
74	375	825	114	1180	2600	154	3750	8250	194	11800	26000
75	387	855	115	1215	2680	155	3875	8550	195	12150	26800
76	400	880	116	1250	2760	156	4000	8800	196	12500	27600
77	412	910	117	1285	2830	157	4125	9100	197	12850	28300
78	425	935	118	1320	2910	158	4250	9350	198	13200	29100
79	437	965	119	1360	3000	159	4375	9650	199	13600	30000
80	450	990	120	1400	3080	160	4500	9900	200	14000	30900
81	462	1020	121	1450	3200	161	4625	10200	201	14500	32000
82	475	1050	122	1500	3300	162	4750	10500	202	15000	33100
83	487	1070	123	1550	3420	163	4875	10700	203	15500	34200
84	500	1100	124	1600	3520	164	5000	11000	204	16000	35300
85	515	1140	125	1650	3640	165	5150	11400	205	16500	36400
86	530	1170	126	1700	3740	166	5300	11700	206	17000	37500
87	545	1200	127	1750	3860	167	5450	12000	207	17500	38600
88	560	1230	128	1800	3960	168	5600	12300	208	18000	39700
89	580	1280	129	1850	4080	169	5800	12800	209	18500	40800

RADIAL FARM
BIAS FARM
FRONTS & IMPLEMENTS
FORESTRY & FLOTATION
DISCONTINUED
LOAD & INFLATION TABLES
GENERAL TIRE INFORMATION
WARRANTY



GENERAL TIRE INFORMATION

CROSS-SECTION CONVERSIONS

CONVENTIONAL SIZE (inches)	METRIC SIZE (millimeters)
8.5	215
9.5	230
10.0	250/260
10.5	265
11.2	280/290
11.8	300
12.4	320
13.6	340
14.0	355/360
14.9	380/385
16.9	420
17.5	445
18.4	460/480
19.5	500
20.8	520/540
23.1	600
24.5	620
25.5	650
28.0	710
30.5	800
35.5	900
43.00	1050
50.00	1250

INTERNATIONAL SPEED SYMBOLS

SPEED SYMBOLS	SPEED CATEGORY (mph)	SPEED CATEGORY (km/h)
A1	2.5	5
A2	5	10
A3	10	15
A4	12.5	20
A5	15	25
A6	20	30
A7	22.5	35
A8	25	40
B	30	50
C	25	60
D	40	65
E	43	70
F	50	80
G	55	90

MILLIMETRIC TIRE SIZES

The markings on some farm tires are millimetric, and the service description is load index and speed symbol. This marking conforms to what is currently used for passenger, truck, agricultural, and earth-mover tires.

EXAMPLE TIRE SIZE – 710/70R38 166A8

710: Tire section width in millimeters

70: Aspect ratio

R: Radial construction

38: Rim diameter in inches

166: Load index

A8: Speed symbol

INDUSTRY CODES

SIZE	SYMBOLS
F-1	Agricultural single-rib tread
F-2	Agricultural multi-rib tread
F-3	Industrial multi-rib tread
G-1	Regular traction tread
G-2	Turf traction tread
I-1	Rib tread
I-3	Traction tread
HF-1	High-flotation shallow tread
HF-2	High-flotation regular tread
HF-3	High-flotation deep-lug tread
HF-4	High-flotation extra-deep lug tread
LS-2	Log skidder
R-1	Drive wheel – regular tread (dry, well-drained soil)
R-1W	Drive wheel – wet traction (wet soil), generally 25% deeper tread than R-1
R-2	Drive wheel – rice and cane (wet, muck)
R-3	Drive wheel – button design (orchards, golf courses, grass cutting, light industrial)
R-4	Drive wheel – industrial use

RADIAL FARM

BIAS FARM

FRONTS & IMPLEMENTS

FORESTRY & FLOTATION

DISCONTINUED

LOAD & INFLATION TABLES

GENERAL TIRE INFORMATION

WARRANTY

GENERAL TIRE INFORMATION

EQUIVALENT LOAD DESIGNATIONS

SIZE	SYMBOL	PLY RATING	LOAD INDEX
13.6R28	★★★	8	126 A8/B
14.9R28	★★★	10	133 A8/B
14.9R30	★★★	10	134 A8/B
14.9R34	★★★	10	136 A8/B
14.9R46	★★★	10	142 A8/B
16.9R24	★★	8 & 10	134 A8/B
16.9R26	★★	8 & 10	135 A8/B
16.9R28	★★	8 & 10	136 A8/B
16.9R30	★★	8 & 10	137 A8/B
16.9R38	★	8	141 A8/B
18.4R26	★★	8 & 10	140 A8/B
18.4R34	★	6 & 8	139 A8/B
18.4R38	★	6 & 8	141 A8/B
18.4R38	★★	10	146 A8/B
18.4R42	★★	10	148 A8/B
18.4R46	★★★	12	155 A8/B
20.8R34	★	8	145 A8/B
20.8R38	★	8	147 A8/B
20.8R38	★★	10	153 A8/B
20.8R42	★★	10	155 A8/B

CONVERSION CHART

1 inch = 25.4 millimeters = 2.54 centimeters
 1 foot = 30.48 centimeters = .3048 meters
 1 mile = 1609.3 meters = 1.6093 kilometers
 1 mile = 5280 feet = 1760 yards
 1 square inch = 6.4516 square centimeters
 1 square foot = 144 square inches
 1 square yard = 9 square feet
 1 square mile = 640 acres
 1 hectare = 2.471 acres
 1 gallon water = 8.3453 pounds of water
 1 U.S. gallon = 3.785 liters
 1 peck = 8 quarts (dry)
 1 bushel = 4 pecks (U.S.)
 1 lbm = .4536 kilogram
 1 lbf = 4.45 Newtons
 1 psi = 6.895 kilopascal (kPa) = .06895 bar

RADIAL FARM

BIAS FARM

FRONTS & IMPLEMENTS

FORESTRY & FLOTATION

DISCONTINUED

LOAD & INFLATION TABLES

GENERAL TIRE INFORMATION

WARRANTY

HOW TO READ AN RCI CHART

UNDERSTANDING ROLLING CIRCUMFERENCE

Rolling circumference can be defined as the distance a tire travels in one revolution. Due to the increase in mechanical front wheel drive (MFWD) tractors in the marketplace, it is very important to understand rolling circumference when trying to determine the proper tire setup for your tractor. Since both the front and the rear tire on MFWD tractors are engaged, the front tire requires more revolutions to cover the same distance as the rear tire. It is necessary to know the gear ratio of the tractor (available from the tractor manufacturer) in order to select the tires that will adequately match the tractor's front-to-rear gear ratio.

The gear ratio on the typical MFWD ranges from 1.2 to 1.5; therefore, the proper setup should allow for front tire over-speed up to 5% (consult with the tractor manufacturer for the preferred lead percentage). When selecting a new size or type of tire for your MFWD tractor, you must choose a front and rear tire combination that matches the ratio provided by the original tires. To make this easier, the tire and tractor industries have created a chart to better assist

customers with tire selections for their tractors. (See chart on next page).

The first column of the table refers to the RCI (rolling circumference index) group. All tires in a group will have a similar rolling circumference and OD. The larger the RCI group number, the larger the tire diameter and rolling circumference. The second column lists the rolling circumference in inches. The third column lists the Tire Diameter (OD) for that RCI group of tires. The chart then displays columns of wider tire widths in both inches and millimeters as you progress from left to right. The top part of the chart shows the width of field rows, and in the columns below each row width, the chart shows the recommended tires for that row width.

To better understand the chart, look at the following example:

A MFWD tractor is set up for 30-inch rows with 480/80R46 (group 47) tires on the rear and 420/90R30 (group 42) tires on the front. Most tractors are five-step tractors, meaning that there is a difference of 5 between the RCI group number of the rear tire and that of the front tire¹. To convert from 30-inch to 22-inch rows, go to the 22" row column and select the 380/90R50 rear, and matching front, 320/85R38.

RADIAL FARM

BIAS FARM

FRONTS & IMPLEMENTS

FORESTRY & FLOTATION

DISCONTINUED

LOAD & INFLATION TABLES

GENERAL TIRE INFORMATION

WARRANTY

¹ Although most tractors are five-step tractors, consult with your manufacturer for the correct ratio for your model.

RCI CHART

ROLLING CIRCUMFERENCE INDEX

- RCI = Rolling Circumference Index (indicates family of tires with similar rolling circumference)
- All sizes in a row are approximately the same outside diameter
- All sizes in the same column are approximately the same width
- For specific applications, consult OEM Data Books for actual dimensions

ROW WIDTH (inches)			20				30		38		WIDE			
SECT. WIDTH (mm)			<=290	320	340	380	420	480	520	580	600	700	800	>=900
RCI	RC (in)	OD (in)	(11.2)	(12.4)	(13.6)	(14.9)	(16.9)	(18.4)	(20.8)	(24.5)	(28.0)	(31.0)	(35.5)	
50	269	91										850/75R42		
49	256	86						480/95R50			710/75R42		900/75R32 900/60R42 1100/50R42	
48	243	81				380/105R50		480/80R50	520/85R46 20.8R46	580/85R42	620/70R46	710/70R42	800/70R38	1250/50R32
47	230	77		320/90R54		380/90R50		480/80R46 18.4R46	520/85R42 20.8R42		620/70R42	710/70R38		900/50R42 900/65R32
46	219	73		320/90R50		380/90R46	420/80R46	480/80R42 460/85R42 18.4R42	520/85R38 20.8R38		650/65R38		800/65R32	900/60R32
45	207	70	270/95R48	320/90R46				480/80R38 460/85R38 18.4R38	520/85R34 520/70R38 20.8R34	580/80R34	600/65R38 23.1R34* 650/70R32 24.5R32		800/60R32 30.5L32	
44	197	66	230/95R48	320/90R42		380/95R38	420/85R38 16.9R38	480/85R34 480/70R38 460/85R34 18.4R34	540/65R38		620/75R30 650/60R34			
43	187	63	230/95R44			380/80R38 400/75R38 15.5R38*	420/85R34 16.9R34	480/70R34	540/65R34		600/70R30 620/75R26 23.1R26*	750/65R26		
42	177	59		320/85R38		380/85R34 14.9R34	420/90R30 420/85R30 16.9R30	480/80R30 480/70R30 460/85R30 18.4R30			600/70R28 600/65R28			
41	168	56	290/95R34	320/85R34		380/85R30 14.9R30	420/85R28 16.9R28	480/70R28 18.4R26	540/65R30					
40	163	53	230/95R36			380/85R28 14.9R28	420/85R26 16.9R26 420/85R24		540/65R24					
39			230/95R32		340/85R28 13.6R28	14.9R26 380/85R26	16.9R24	480/70R34						
38				320/85R28	340/85R24 13.6R24 360/70R28 *	380/70R28 380/85R24 14.9R24	420/70R24	480/65R24						
37				320/85R24 12.4R24		380/70R24*								

RADIAL FARM
 BIAS FARM
 FRONTS & IMPLEMENTS
 FORESTRY & FLOTATION
 DISCONTINUED
 LOAD & INFLATION TABLES
 GENERAL TIRE INFORMATION
 WARRANTY

APPROVED RIM CONTOURS

AGRICULTURAL STANDARD DRIVE WHEEL TIRES

RADIAL FARM

BIAS FARM

FRONTS & IMPLEMENTS

FORESTRY & FLOTATION

DISCONTINUED

LOAD & INFLATION TABLES

GENERAL TIRE INFORMATION

WARRANTY

TIRE SIZE	APPROVED RIM CONTOURS
4.50-10	2.50C, 3.00D
5-12	4JA
5-14	4JA
5.00-15	3.00D
5.90-15	4J, 4 1/2KB, 5KB
6-12	5JA
6-14	5KB, 5JA
6.00-16 (4)	4.50E, 4 1/2KB, 5.50F
6.50-16	4.00E, 4.25KA, 4.50E, 5.50F
6.50-16	4.00E, 4.25KA, 4.50E, 4 1/2KB
6.70-15	4 1/2KB, 5KB
7-14	5KB, 5JA
7-16	6LB, 6L, 6.00F
7.5L-15	5KB, 6LB
7.50-16	5.50F, 6LB
7.50-20	5.50F
7.60-15	6LB
8-16	6LB, 6L, 6.00F
8-18	5.50F
8.3-22	W7
8.3-24	W7
8.5L-14	6KB, 8KB
9.00-24	W8H
9.5-16	W8L, 8LB
9.5-22	W7, W8
9.5-24	W7, W8, W8H
9.5-32	W7, W8
9.5-36	W8
9.5-42	W8, W9
9.5L-14	8KB
9.5L-15, 9.5L-15FI	8LB
10.00-15	8LB
10.00-16	W8L, 8LB
11.00-16	W8L, 8LB, W10L, 10LB
11.00-24	W10, W10H
11L-14	8KB
11L-15	8LB, 10LB
11L-15FI	8.5J, W8L, 8LB, 10LB
11L-16	W8L, 8LB, W10L, 10LB
11.2-24	W9, W10, W10H
11.2-28	W9, W10, W10H
11.2-36	W9
11.2-38	W10
11.25-24	W8, W8H, W10, W10H
11.25-28	W8, W8H, W10, W10H
12.4-16	W10L, 10LB
12.4-24	W10, W11, W10H

TIRE SIZE	APPROVED RIM CONTOURS
12.4-28	W11, W10, W10H
12.4-38	W11, DW11A, W10
12.4-42	W10
12.5L-15, 12.5L-15FI	10LB
12.5L-16	W10L, 10LB
13.50-16.1	16.1Xw11C
13.6-16	W10L, W12L
13.6-24	W11, W12
13.6-28	W11, W12
13.6-38	W12, DW12A, W11
13.6-46	W12A
14L-16.1	16.1xW11C
14.9-24	W12, W13
14.9-26, 14.9R26	W12, DW12A
14.9-28	W12, W13
14.9-30	W13, DW13A
14.9-38	W12, DW12A
14.9R46	W12A, W12B, DW12A, W13A, W13B, DW13A, DW13B
15.5-38	W14L, DW14A
15.5R38	W14L
16.9-24	W15L
16.9R24	W14L, W15L
16.9-26	W15L, DW14A, DW15A
16.9-28, 16.9R28	W15L, W14L
16.9-30	W15L, DW15A, W14L, DW14A
16.9R30	W14L, DW14A, W15L, DW15A
16.9-38	W15L, W15A, W14L, DW14A
17.5L-24	W15L
18.4-16.1	16.1xW16C, 16.1xW16CH
18.4-26	DW16A, W15L, DW15A
18.4R26	W15L, W16L, DW16A
18.4-28	W16L, W16A, W15L
18.4R28	W15L, W16L, DW16A
18.4-30	DW16A, W15L, DW15A
18.4-34	DW16A, W16L, W15L
18.4R34	W15L, W16L, W16A, DW16A
18.4-38	W16A, W15L, DD16
18.4R38	W15A, W15L, DW15A, W16A, DW16A, DD16
18.4-42, 18.4R42	W16A, DD16, DW16A
19L-16.1	16.1xW16C, 16.1xW16CH
19.5L-24	W16L, DW16A, W15L
20x8.00-10	6.00I
20.8-34	W18L
20.8-38	W18A, DD18, DW18A
20.8R38	W18A, DW18A, DD18
20.8-42	W18A, DD18, DW18A

APPROVED RIM CONTOURS

AGRICULTURAL STANDARD DRIVE WHEEL TIRES

TIRE SIZE	APPROVED RIM CONTOURS
20.8R42	W18A, DW18A, DD18
21.5L-16.1	16.1xW16C, 16.1xW16CH, 16.1xW18C, 16.1xW18CH
20.8-38	W18A, DD18, DW18A
23x8.50-12	7JA
23x10.50-12	7JA
23.1-26	DW20A, DW20B
23.1-30	DW20A, DW20B
23.1-34	DW20A, DW20B
23.1R34	DW20A, MW20A, MW20B, DW20B
24x8.50-12	7JA
24.5-32	DW20A, DW20B, DH21, DW21A, DW21B, DH21B, DH21HB, DH21H
24.5R32	DH21, DW21A, DH21B, DW21B, DH21H, DH21HB
25x8.50-14	7.00-I-55, I-70, I-90, 7.0AT
26x12.00-12	8.50-I-55, I-70, I-90, 8 1/2JA, 8.50AT, 9 1/2JA, 9.5AT, 10 1/2JA, 10.5-I-55, I-70, I-90, 10.5AT
27x8.50-15	7JA
27x9.50-15	7JA, 8LB
28L-26	DW25A, DW25B
29x12.00-15	10LB
30.5L-32 (16 & HP)	DH27, DH27B, DH27H, DH27HB
30.5L-32 (12 & 14)	DW27A, DW27B, DH27B, DH27, DH27H, DH27HB
30.5LR32	DH27, DW27A, DH27B, DW27B, DH27HB
31x13.50-15	10LB
31x15.50-15	13LB
35.5L-32	31VA
36x16-17.5	10.5
36x16B17.5	10.5
40x19B19.5	15
42x25.00-20	20.50HF, 20.50VF
48x25.00-20	20.50HF, 20.50VF
48x31.00-20	26.00HF, 26.00VF
54x37.00B25	32.0TH
67x34.00B25	30.0TH
67x34.00-26	DW30A, DW30B
73x44.00-32	36.0VA
76x50.00-32	44DWM
24x8.50-14	7JA
24.5-32	DW20A, DW20B, DH21, DW21A, DW21B, DH21B, DH21HB, DH21H
25x8.50-14	7.00-I-55, I-70, I-90, 7.0AT
26x12.00-12	8.50-I-55, I-70, I-90, 8 1/2JA, 8.50AT, 9 1/2JA, 9.5AT, 10 1/2JA, 10.5-I-55, 10.5AT
27x8.50-15	7JA

TIRE SIZE	APPROVED RIM CONTOURS
27x9.50-15	7JA, 8LB
28L-26	DW25A, DW25B
29x12.00-15	10LB
30.5L-32 (12&14)	DW27A, DW27B, DH27B, DH27, DH27H, DH27HB
30.5L-32 (16&HP)	DH27, DH27B, DH27H, DH27HB
30.5L-R32	DH27, DW27A, DH27B, DH27H, DW27B, DH27HB
31x13.50-15	10LB
31x15.50-15	13LB
33x15.50-16.5	12
35.5L-32	31VA
36x16-17.5	10.5
36x16B17.5	10.5
40x19B19.5	15
42x25.00-20	20.50HF, 20.50VF
48x25.00-20	20.50HF, 20.50VF
48x31.00-20	26.00HF, 26.00VF
54x37.00B25	32.0TH
66x43.00-25	36.0TH
66x43.00-26	DW36A, DW36B
66x44.00-25	36.0TH
67x34.00B25	30.0TH
67x34.00-26	DW30A, DW30B
73x44.00-32	36.0VA
76x50.00-32	44DWM

RADIAL FARM

BIAS FARM

FRONTS & IMPLEMENTS

FORESTRY & FLOTATION

DISCONTINUED

LOAD & INFLATION TABLES

GENERAL TIRE INFORMATION

WARRANTY

APPROVED RIM CONTOURS

AGRICULTURAL METRIC DRIVE WHEEL TIRES

RADIAL FARM

BIAS FARM

FRONTS & IMPLEMENTS

FORESTRY & FLOTATION

DISCONTINUED

LOAD & INFLATION TABLES

GENERAL TIRE INFORMATION

WARRANTY

TIRE SIZE	APPROVED RIM CONTOURS
IF200/90R15	6LB
IF210/75R15	6LB, 7KB
215/80D15	7
230/95R32	8
230/95R36	W7, W8
230/95R44	8
230/95R48	W7, W8
IF240/80R15	8LB, 8L
VF245/70R19.5	6.75, 7.50
VF255/70R22.5	7.50, 8.25
VF265/70R19.5	7.50, 7.50RW, 8.25, 8.25RW
IF265/85R15	8L, 8LB
270/95R48	W9-W8, W9, W10
IF280/70R15	8LB, 10L, 10LB
280/70R18	W8L, W9, W10L
280/85R24	W9, W10
VF285/70R19.5	7.50, 8.25, 9.00
290/85D38	W10
290/95R34	W10
VF295/75R22.5	8.25, 9.00
IF320/65R15	10LB
IF320/70R15	10LB
320/85R24	W9, W10, W10H, W11
320/85R28	W9, W10, W11
320/85R34	W10
320/85R36	W10, DW10A, W11, DW11A
320/85R38	W10, DW10A, W11, DW11A
320/90R42	W9, W10
320/90R46	W10A, DW10A
320/90R50	W10A, DW10A
320/90R54	W10A
340/85R24	W11, W12
340/85R28	W11, W12
355/80D20	W11
360/70R20	W10, W11, W12
360/70R28	W11, W12, W13
380/70R24	W11, W12, W13
380/70R28	W11, W12, W13
380/85R26	W11, W12, W13
380/80R38	W12, DW12A
IF380/80R38	W12, DW12A
VF380/80R38	W12, DW12A
380/85D24	W12, W13
380/85R24	W11, W12, W13
380/85R28	W11, W12, W13
380/85R30	W12, W13, DW13A
IF380/85R34	W12, W13
380/90R46	W12A, W12B, DW12A, W13A, W13B, DW13A, DW13B

TIRE SIZE	APPROVED RIM CONTOURS
IF380/90R46	W12A, W12B, DW12A, W13A, W13B, DW13A, DW13B
VF380/90R46	W13A, W13B, DW13A, D13B
VF380/90R50	W12A, DW12A, W13A, DW13A
VF380/95R38	W12A
VF380/90R54	W12A
380/105R50	W12A, W12B, DW12A, W13A, W13B, DW13B
380/105R50	W12A, DW12A, W13A, DW13B
IF380/105R50	DW13B
VF380/105R50	DW13B, W13B, DW12B, W12B
VF385/65R22.5	11.75, 12.25
385/85R34	W12, W13
395/55D16.5	12
400/70R24	W13, W15L
400/75R38	W13, 14L
400/80R24	W13
420/70-24	W13
420/70R24	W12, W13, W14L
420/80R46	W12A, W13A, DW13A
IF420/80R46	W13B, DW13B
420/85R24	W14L, W15L
420/85R26	W15L
VF420/80R46	W13B, DW13B
420/85R24	W14L, W15L
420/85R26	W15L
420/85R28	W14L, W15L
420/85R30	W14L, DW14A, W15L, DW15A
420/85R34	W13L, W15L
IF420/85R34	W13, DW13A, W14L
VF420/85R34	W13, DW13A, W14L
420/85R34	W14L, W15L, DW15L
IF420/85R38	W15A
VF420/85R38	W15A
420/90R30	W14L, DW14A, W15L, DW15A
440/65R24	W13, W14L, W15L, W16L, DW16A
440/65R28	W13, W14L, W15L, W16L, DW16A
VF445/50R22.5	14.00, 15.00
VF445/65D22.5	13.00, 14.00
460/85R30	W15L, DW15A, W16L
460/85R34	W15L, W16L, W16A, DW16A
460/85R38	W15L, W16L
460/85R42	W16A
480/65R24	W14L, W15L, W16L, DW16A
480/65R28	W14L, W15L, W16L, DW16A
480/70R24	W14L, W15, W16L, DW16A
480/70R28	W15L, W16L, DW16A
480/70R30	W15L, DW15A, W16L

APPROVED RIM CONTOURS

AGRICULTURAL METRIC DRIVE WHEEL TIRES

TIRE SIZE	APPROVED RIM CONTOURS
480/70R34	W15L, W16L, W16A
480/80R30	W15L, DW15A, W16L
480/80R38	W15A, W15L, DW15A, W16A, DW16A, DD16
480/80R42	W16A, DW16A, DD16
480/80R46	W16A, DW16A, DD16
IF480/80R46	W16A, DW16A, DD16
VF480/80R46	W16A, DW16A, DD16
480/80R50	W15A, W15B, DW15A, DW15B, W16B, DW16A, DW16B
IF480/80R50	W15A, W15B, DW15A, DW15B, W16B, DW16A, DW16B
VF480/80R50	W15A, W15B, DW15A, DW15B, W16B, DW16A, DW16B
480/85R34	W15L, W16L, W16A, DW16A
IF480/95R50	W15A, W15B, DW15A, DW15B, W16B, DW16A, DW16B
VF480/95R50	W15A, W15B, DW15A, DW15B, W16B, DW16A, DW16B
520/70R38	W15A, W15L, W16L, W16A, DD16, W18A, DD18
520/85R34	W16A, DW16A, W18A
IF520/85R34	W18A, W18L
520/85D38	W18A, DD18, DW18A
520/85R38	W18A, DD18, DW18A
520/85R42	DW16A, DD16, DW16A, W18A, DD18, DW18A, DW18B
IF520/85R42CFO	DW16A, DD16, DW16A, W18A, DD18, DW18A, DW18B
VF520/85R42CFO	DW16A, DD16, DW16A, W18A, DD18, DW18A, DW18B
520/85R46	W16A, DW16A, DD16, DD18
IF520/85R46	W16A, W18A, DD16
VF520/85R46	W16A, W18A, DD16
540/65R24	W16L, DW16A, W18L
540/65R28	W16L, W18L, DW16A, DW18A
540/65R30	W16L, W16A, DW16A, DW18A
540/65R34	W16L, W18L, W18A, DW16A
540/65R38	W16L, W16A, W18A, DW16A, DW18A
580/70R42	W18A, DW18A, DD18
IF580/80R34	DW20B, MW20B, DW21B
580/85R42	W18A, DW18A, DW18B, DD18, DW20B, MW20B
IF580/85R42CFO	DW20B, MW20B
VF580/85R42CFO	DW20B, MW20B
600/55-22.5	AG20.00
600/65R28	W18L, DW18A
600/65R34	W18L, DW20B, MW20B
600/65R38	W18L, DW18A, DW20B
600/70R38	W18L, DW18A
600/70R30	DW18A, DW20B
IF600/70R30	DW20B, DW21B
VF600/70R30	DW20B, DW21B

TIRE SIZE	APPROVED RIM CONTOURS
620/70R42	DW20B, MW20B
620/70R46	DW20B, MW20B
VF620/70R46	DW20B, MW20B
VF620/75R26	DW20B
VF620/75R26CFO	DW20B
620/75R30	DW20B
IF620/75R30	DW21B, DW23B
VF650/60R34	DW23B
650/65R38 (157B)	W18A, DD18, DW18A
650/65R38 (175A8/B)	DW20B, MW20B, DW23B, MW23B
650/65R42	DW20B, MW20B
650/75R32	DH21, DW21A, DH21B, DW21B, DH21H, DH21HB
650/85R38	DW20B, MW20B, DW23B, MW23B
IF650/85R38	DW20B, MW20B, DW23B, MW23B
700/50-22.5	AG24.00
710/70R38	DW23B, MW23B
IF710/70R38	DW23B, MW23B, DW25B, MW25B
710/70R42	DW23B, MW23B
IF710/70R42	DW23B, MW23B, DW25B, MW25B
IF710/75R42	DW25B, MW25B
750/65R26	DW25B
VF750/65R26	DW25B
VF750/65R26CFO	DW25B
IF800/60R32CFO	DW27B, MW27B, MW28B
800/65R32	DW25B, DH27, DH27B, DH27H, DW27B, DH27HB
800/70R38	DW25B, MW25B, DW27B, MW27B, MW28B
IF800/70R38	DW27B, MW27B, MW28B
IF800/70R38CFO	DW27B, MW27B, MW28B
VF800/70R38	DW27B, MW27B, MW28B
VF800/70R38CFO	DW27B, MW27B, MW28B
IF850/75R42	DW27B, DW28B, MW28B, DW30B, MW30B
IF850/75R42CFO	DW30B, MW30B
900/50R42	DW28B, MW28B
900/60R32	DW27B, DH27, DH27H, DH27B, DH27HB, DH28HB, DW31B, DH31, DH31H, DH31B, DH31HB
IF900/60R32CFO	DW30B, DW31B, DH31B, DH31HB
VF900/60R32CFO	DW30B, DW31B, DH31B, DH31HB
VF900/60R42	DW30B, MW30B
900/65R32	DW27B, DH27, DH27H, DH27B, DH27HB, DH28HB, DW31B, DH31, DH31H, DH31B, DH31HB
IF900/65R32CFO	DW30B, DW31B, DH31B, DH31HB
900/75R32	DW27B, DH27, DH27H, DH27B, DH27HB, DH28HB, DW31B, DH31, DH31H, DH31B, DH31HB
IF900/75R32CFO	DW30B, DW31B, DH31B, DH31HB
IF1100/50R42CFO	DW38B, DW40B
IF1250/50R32CFO	DW44B, 44DWM, DH44B, DH44HB

RADIAL FARM

BIAS FARM

FRONTS & IMPLEMENTS

FORESTRY & FLOTATION

DISCONTINUED

LOAD & INFLATION TABLES

GENERAL TIRE INFORMATION

WARRANTY

APPROVED RIM CONTOURS

FORESTRY TIRES

RADIAL FARM

BIAS FARM

FRONTS & IMPLEMENTS

FORESTRY & FLOTATION

DISCONTINUED

LOAD & INFLATION TABLES

GENERAL TIRE INFORMATION

WARRANTY

TIRE SIZE	APPROVED RIM CONTOURS
CONVENTIONAL	
16.9-30	W15L, DW15A, W14L, DW14A
18.4-26	DW16A
18.4-34	DW16A
23.1B26	DW20A, DW20B
24.5B32	DH21, DH21B, DH21H, DH21HB
FLOTATION	
DH73x44.00B32	DH36, DH36B, DH36H, DH36HB, 36DWM
76x50.00B32	44DWM
LOW PROFILE	
21.5L-16.1	16.1xW16C, 16.1xW16CH, 16.1xW18C, 16.1xW18CH
28LB26	DW25A, DW25B
30.5LB32	DH27, DH27B, DH27H, DH27HB
35.5LB32	DH31, DH31B, DH31H, DH31HB

FORESTRY METRIC TIRES

TIRE SIZE	APPROVED RIM CONTOURS
600/55B26.5	AG20.00
600/65B34	DW20A
700/50B26.5	AG24.00
700/55B34	DW24A
710/45B26.5	AG24.00
750/55B26.5	AG24.00

HYDROINFLATION

HYDROINFLATION PROCEDURE FOR FLUID BALLAST

TO FILL

1. After the beads have been fully seated in the mounting procedure, inflate the tire to 35 psi (240 kPa). Jack up the wheel and rotate the wheel assembly so the valve is at the top of the rim. Lower the jack until the tire is slightly deflected.

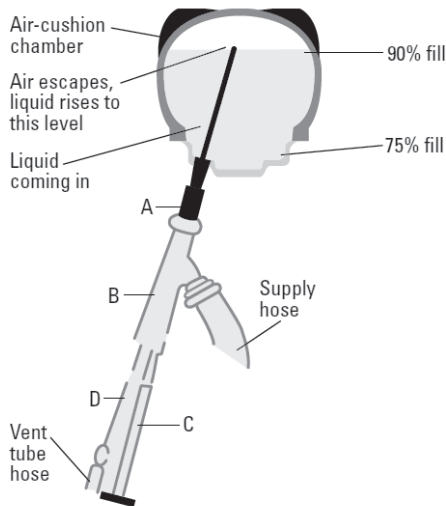

2. Connect the assembly to fill the tire with fluid as shown in illustration below.



Attach adapter and unit assembly part A to valve stem. Do not use pliers. Also attach supply hose to part B. Part C is used to remove core housing.

In warm climates where calcium-chloride may not be desired, tires can be filled with water only. A pump is not necessary when only water fill is used. Tires may be filled directly by using a valve adapter on a hose.

3. After the connection (in step 2) is made, bleed the air pressure down to about 5 psi (35 kPa) by moving the control handle (part C) to the evacuate position. Five psi (35 kPa) keeps the beads seated on the rim.
4. When this point is reached, start the pump and move the control handle to the fill position. Use a hydroinflation pump to fill the tire with calcium chloride or non-damaging anti-freeze solution (consult tube or tire manufacturer for recommendations). Check the pressure in the tire every few minutes with the pump gauge by placing the pump in neutral or check position. If the pressure exceeds 20 psi (140 kPa), move the handle to the evacuate position, until the pressure is bled back to not less than 5 psi (35 kPa). After the pressure is lowered, continue to add fluid.

Repeat the above steps as often as necessary. Industry practice is to maintain the fluid level at 75%. (Fluid fill should be maintained at a level sufficient to cover the valve and keep the rim completely submerged).

5. Replace the core housing in the valve stem by pushing the handle in until the housing is screwed tightly into the valve stem. Then withdraw the handle. Turn the handle to evacuate and pump all the liquid from the hose. Next, shut off the pump and unscrew the assembly from the valve.

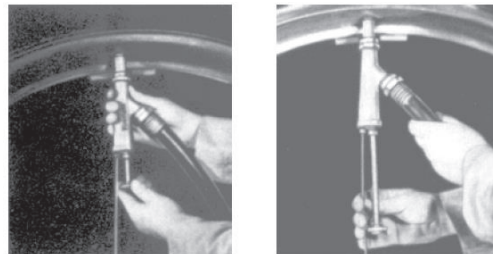

Tire being filled with hydroinflation equipment.

6. Inflate the tire to seat the beads, not exceeding 35 psi (240 kPa). With the valve stem still at the top, bleed the excess fill down to 1-2 psi (7-14 kPa) above the recommended inflation pressure.
7. Finally, rotate the tire and wheel assembly so that the valve is at the bottom of the tire. Set the final operating pressure with the tire mounted on the tractor and its full weight on the tire.

RADIAL FARM

BIAS FARM

FRONTS & IMPLEMENTS

FORESTRY & FLOTATION

DISCONTINUED

LOAD & INFLATION TABLES

GENERAL TIRE INFORMATION

WARRANTY

HYDROINFLATION

HYDROINFLATION PROCEDURE FOR FLUID BALLAST

TO REMOVE FILL:

1. Jack up the tractor until the tire is slightly deflected. Rotate the tire and wheel assembly until the valve is at the bottom.
2. Connect the assembly to the valve stem. Unscrew and retract the core housing (part C) into ejector body with the control handle in the check or neutral position. Attach the adapter (part B) to the valve. Remove the core housing and connect the supply hose to the adapter B.
3. Start the pump and turn the control handle to the evacuate position. The fluid is rapidly withdrawn from the tire. Gravity flow may also be used to remove the fluid.

When removing fluid from tubeless tires, be careful not to unseat the beads until most of the fluid has been pumped from the tire. Consult your tire supplier for information on hydroinflation equipment such as pumps, compressors, air-water conversion hardware parts, etc.

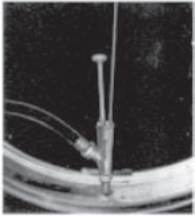

Tire rotated so valve is at bottom with hydroinflation fluid being removed.

NOTES:

1. Tables are based on using type 1 calcium chloride (77% CaCl₂). If type 2 concentrated calcium chloride (94% CaCl₂) is used, reduce specified "CaCl₂ Lbs" in tables by 25%.
2. Values shown in tables are approximate and represent 75% fill or "valve-level" fill (with valve at top of tire), which is recommended practice.
3. Anti-freeze protection levels are shown at the top of each table for different solutions.
4. For rear tires mounted on narrower rims, decrease quantities at the rate of 4% for each 1" reduction in rim width. For wider rims, increase quantities by 4% for each 1" increase in rim width.

RADIAL FARM

BIAS FARM

FRONTS &
IMPLEMENTES

FORESTRY &
FLOTATION

DISCONTINUED

LOAD & INFLATION
TABLES

GENERAL TIRE
INFORMATION

WARRANTY

HYDROINFLATION

DRIVE WHEEL TIRES

TIRE SIZE	RIM WIDTH	WATER		3½ LB SOLUTION			5 LB SOLUTION		
		SOLID AT +32° F ¾ FILL H ₂ O	H ₂ O WEIGHT	SLUSH-FREE TO -12° F SOLID AT -52° F		TOTAL WT.	SLUSH-FREE TO -53° F SOLID AT -62° F		TOTAL WT.
		GAL H ₂ O	CaCl ₂ LBS		GAL H ₂ O		CaCl ₂ LBS		
6-14	5.00	5.6	47	5	17	57	5	23	60
24x8.50-14	7.00	5.0	42	4x	15	51	4	20	54
200/85D14	7.00	8.2	68	7	24	83	7	33	88
215/65D14	6.00	6.9	57	6	21	70	6	28	74
29x12.00-15	10.00	15.5	129	13	47	157	13	63	167
31x13.50-15	10.00	19.0	158	16	57	193	15	77	205
8-16	6.00	10.7	90	9	32	109	9	43	116
9.5-16	8.00	14.1	118	12	42	143	11	57	152
12.4-16	11.00	27.1	226	23	81	275	22	110	293
13.6-16	12.00	36.0	300	31	108	365	29	146	388
18.4-16.1	16.00	60.7	506	52	182	616	49	246	655
21.5L-16.1	18.00	68.4	571	59	205	695	55	277	738
250/85D16.5	8.25	14.2	118	12	43	144	11	57	153
265/55D16.5	8.25	10.2	85	9	30	103	8	41	110
320/55D16.5	9.75	14.6	121	12	44	148	12	59	157
380/70D19.5	11.75	37.1	310	32	111	377	30	150	401
9.5-22	8.00	19.9	166	17	60	202	16	80	214
8.3-24	7.00	13.7	114	12	41	139	11	55	148
9.5-24	8.00	18.7	156	16	56	190	15	76	202
11.2-24	10.00	26.3	220	23	79	267	21	107	284
12.4-24	11.00	34.0	284	29	102	345	28	138	367
13.6-24	12.00	42.1	352	36	126	428	34	170	455
14.9-24	13.00	54.4	454	47	163	552	44	220	587
16.9-24	15.00	69.9	583	60	210	710	57	283	755
16.9R24	15.00	68.6	572	59	206	696	55	277	740
19.5L-24	16.00	82.2	686	70	247	834	57	333	887
320/85R24 (12.4R24)	10.00	30.0	250	26	90	304	24	121	323
340/85R24 (13.6R24)	11.00	37.0	309	32	111	376	30	150	400
380/85D24	12.00	51.8	432	44	155	526	42	210	559
380/85R24 (14.9R24)	12.00	46.7	389	40	140	474	38	189	504
460/60D24	15.00	55.0	458	47	165	558	44	222	593
480/65R24	15.00	60.9	508	52	183	619	49	246	658
540/65R24	16.00	77.8	649	67	233	790	63	315	840
14.9-26	13.00	55.6	464	48	167	565	45	225	601
14.9R26	13.00	54.3	453	47	163	552	44	220	586
16.9-26	15.00	73.7	615	63	221	748	60	298	795
18.4-26	16.00	90.4	754	78	271	918	73	366	976
18.4R26	16.00	89.3	745	77	268	906	72	361	964
23.1-26	20.00	147.1	1227	126	441	1493	119	595	1587
23.1R26	20.00	141.4	1179	121	424	1435	114	572	1526
28L-26	25.00	171.7	1432	147	515	1743	139	695	1853
420/85R26 (16.9R26)	15.00	72.5	604	62	217	735	59	293	782
750/65R26	25.00	188.0	1568	161	564	1909	152	761	2029
VF750/65R26	27.00	192.2	1603	165	577	1951	156	778	2075

RADIAL FARM
 BIAS FARM
 FRONTS & IMPLEMENTS
 FORESTRY & FLOTATION
 DISCONTINUED
 LOAD & INFLATION TABLES
 GENERAL TIRE INFORMATION
 WARRANTY

HYDROINFLATION

DRIVE WHEEL TIRES

TIRE SIZE	RIM WIDTH	WATER		3½ LB SOLUTION			5 LB SOLUTION		
		SOLID AT +32° F 3/4 FILL H ₂ O	H ₂ O WEIGHT	SLUSH-FREE TO -12° F SOLID AT -52° F		SLUSH-FREE TO -53° F SOLID AT -62° F		TOTAL WT.	
		GAL H ₂ O	CaCl ₂ LBS	TOTAL WT.	GAL H ₂ O	CaCl ₂ LBS	TOTAL WT.		
11.2-28	10.00	31.6	263	27	95	320	26	128	341
12.4-28	11.00	39.0	326	33	117	396	3% ₀ 2	158	421
13.6-28	12.00	46.6	389	40	140	473	38	189	503
14.9-28	13.00	58.5	488	50	175	593	47	236	631
16.9-28	15.00	77.7	648	67	233	789	63	314	839
16.9R28	15.00	70.3	586	60	211	713	57	284	758
18.4-28	16.00	97.9	817	84	294	994	79	396	1057
18.4R28	16.00	87.4	729	75	262	887	71	353	943
340/85R28 (13.6R28)	12.00	45.3	378	39	136	460	37	183	489
380/85R28 (14.9R28)	13.00	56.7	473	49	170	575	46	229	611
420/85R28 (16.9R28)	15.00	75.6	631	65	227	767	61	306	816
480/70R28	15.00	81.0	675	69	243	822	65	327	874
600/65R28	18.00	109.1	910	94	327	1108	88	441	1178
600/70R28	18.00	115.7	965	99	347	1175	94	468	1249
14.9-30	13.00	61.1	510	52	183	620	49	246	659
16.9-30	15.00	83.9	700	72	252	852	68	338	906
16.9R30	15.00	82.3	686	71	247	835	67	333	888
18.4-30	16.00	102.7	857	88	308	1043	83	416	1109
23.1-30	20.00	168.3	1404	144	505	1709	136	681	1817
380/85R30 (14.9R30)	13.00	55.2	460	47	166	560	45	223	596
420/90R30 (16.9R30)	15.00	76.1	635	65	228	773	62	308	822
480/70R30	15.00	83.7	698	72	251	850	68	339	904
480/80R30 (18.4R30)	15.00	90.9	758	78	273	923	74	368	981
540/65R30	16.00	91.4	762	78	274	927	74	370	986
600/70R30	20.00	129.8	1082	111	389	1317	105	525	1401
IF600/70R30	20.00	131.3	1095	113	394	1333	106	531	1417
9.5-32	8.00	24.3	202	21	73	246	20	98	262
24.5-32	21.00	195.3	1628	167	586	1982	158	790	2107
24.5R32	21.00	188.2	1570	161	565	1910	152	761	2031
30.5L-32	27.00	244.1	2036	209	732	2478	197	987	2634
30.5LR32	27.00	236.6	1973	203	710	2401	191	957	2553
35.5L-32	31.00	350.2	2921	300	1051	3555	283	1417	3779
650/75R32	21.00	173.3	1445	149	520	1759	140	701	1870
800/60R32	27.00	252.0	2101	216	756	2557	204	1019	2719
IF800/60R32CFO	27.00	252.0	2101	216	756	2557	204	1019	2719
900/60R32	27.00	301.9	2518	259	906	3064	244	1221	3258
900/65R32	31.00	328.7	2741	282	986	3336	266	1329	3547
IF900/60R32CFO	30.00	307.8	2567	264	924	3124	249	1245	3322
IF1250/50R32CFO	44.00	518.3	4323	444	1555	5261	419	2097	5594
16.9-34	15.00	92.1	768	79	276	935	75	373	994
18.4-34	16.00	109.8	916	94	330	1115	89	444	1185
18.4R34	16.00	107.8	899	92	323	1094	87	436	1163
20.8-34	18.00	146.1	1219	125	438	1483	118	591	1577
23.1-34	20.00	180.6	1506	155	542	1833	146	731	1949

RADIAL FARM

BIAS FARM

FRONTS &
IMPLEMENTS

FORESTRY &
FLOTATION

DISCONTINUED

LOAD & INFLATION
TABLES

GENERAL TIRE
INFORMATION

WARRANTY

HYDROINFLATION

DRIVE WHEEL TIRES

TIRE SIZE	RIM WIDTH	WATER		3½ LB SOLUTION			5 LB SOLUTION		
		SOLID AT +32° F		SLUSH-FREE TO -12° F			SLUSH-FREE TO -53° F		
		3/4 FILL H ₂ O	H ₂ O WEIGHT	GAL H ₂ O	CaCl ₂ LBS	TOTAL WT.	GAL H ₂ O	CaCl ₂ LBS	TOTAL WT.
23.1R34	20.00	171.6	1431	147	515	1742	139	694	1852
290/95R34	10.00	37.3	311	32	112	379	30	151	403
320/85R34	10.00	39.3	328	34	118	399	32	159	424
380/85R34 (14.9R34)	13.00	61.6	513	53	185	625	50	249	664
420/85R34 (16.9R34)	13.00	79.0	659	68	237	802	64	320	853
IF420/85R34	14.00	78.5	655	67	236	797	64	318	847
480/85R34	16.00	107.2	894	92	322	1088	87	434	1157
520/85R34 (20.8R34)	18.00	136.1	1135	117	408	1382	110	551	1469
9.5-36	8.00	26.4	221	23	79	268	21	107	285
12.4-36	11.00	47.3	395	41	142	480	38	191	511
13.6-36	12.00	61.5	513	53	184	624	50	249	664
11.2-38	10.00	39.2	327	34	118	398	32	159	424
12.4-38	11.00	46.1	384	39	138	468	37	186	497
13.6-38	12.00	61.8	516	53	186	628	50	250	667
14.9-38	13.00	77.6	647	67	233	788	63	314	837
15.5-38	14.00	69.3	578	59	208	703	56	280	748
15.5R38	14.00	67.6	564	58	203	686	55	273	730
16.9-38	15.00	99.4	829	85	298	1009	80	402	1072
18.4-38	16.00	115.7	965	99	347	1175	94	468	1249
18.4R38	16.00	116.6	973	100	350	1184	94	472	1259
20.8-38	18.00	152.4	1271	131	457	1547	123	616	1644
20.8R38	18.00	151.5	1263	130	455	1538	123	613	1635
290/85D38	10.00	40.8	340	35	122	414	33	165	440
320/85R38	10.00	43.2	361	37	130	439	35	175	467
380/80R38	12.00	62.1	518	53	186	630	50	251	670
IF380/80R38	12.00	61.6	514	53	185	626	50	249	665
420/85R38 (16.9R38)	14.00	73.1	610	63	219	742	59	296	789
IF420/85R38	14.00	68.7	573	59	206	697	56	278	741
480/80R38 (18.4R38)	15.00	109.8	916	94	329	1115	89	444	1185
520/85D38	18.00	149.9	1250	128	450	1521	121	606	1618
520/85R38 (20.8R38)	18.00	141.6	1181	121	425	1437	115	573	1528
540/65R38	16.00	107.1	893	92	321	1087	87	433	1156
600/65R38	18.00	136.7	1140	117	410	1387	111	553	1475
650/65R38	20.00	178.3	1487	153	535	1810	144	721	1924
650/85R38	23.00	249.0	2076	213	747	2527	201	1007	2687
IF650/85R38	23.00	249.0	2076	213	747	2527	201	1007	2687
710/70R38	23.00	230.0	1919	197	690	2335	186	931	2483
IF710/70R38	25.00	230.3	1921	197	691	2337	186	932	2485
800/70R38	25.00	298.5	2489	256	896	3029	241	1207	3221
IF800/70R38	25.00	300.1	2503	257	901	3046	243	1214	3239
IF800/70R38CFO	25.00	295.7	2466	253	887	3001	239	1196	3191
9.5-42	8.00	30.1	251	26	90	306	24	122	325
12.4-42	9.00	45.0	375	39	135	457	36	182	486

RADIAL FARM
BIAS FARM
FRONTS & IMPLEMENTS
FORESTRY & FLOTATION
DISCONTINUED
LOAD & INFLATION TABLES
GENERAL TIRE INFORMATION
WARRANTY

HYDROINFLATION

DRIVE WHEEL TIRES

TIRE SIZE	RIM WIDTH	WATER		3½ LB SOLUTION			5 LB SOLUTION		
		SOLID AT +32° F		SLUSH-FREE TO -12° F			SLUSH-FREE TO -53° F		
		3/4 FILL H ₂ O	H ₂ O WEIGHT	GAL H ₂ O	CaCl ₂ LBS	TOTAL WT.	GAL H ₂ O	CaCl ₂ LBS	TOTAL WT.
18.4-42	16.00	129.5	1080	111	389	1314	105	524	1397
18.4R42	16.00	125.2	1044	107	376	1271	101	506	1351
20.8-42	18.00	163.3	1362	140	490	1658	132	661	1762
20.8R42	18.00	163.0	1359	140	489	1654	132	659	1759
320/90R42	10.00	49.9	417	43	150	507	40	202	539
480/80R42 (18.4R42)	16.00	118.0	984	101	354	1198	95	477	1274
520/85R42 (20.8R42)	18.00	155.0	1292	133	465	1573	125	627	1672
IF520/85R42CFO	18.00	154.5	1288	132	464	1568	125	625	1667
580/85R42	18.00	198.0	1651	170	594	2009	160	801	2136
620/70R42	20.00	175.0	1460	150	525	1776	142	708	1889
710/70R42	23.00	240.7	2008	206	722	2443	195	974	2598
IF710/70R42	25.00	247.6	2065	212	743	2513	200	1002	2672
IF710/75R42	25.00	286.2	2387	245	859	2905	232	1158	3089
IF850/75R42	30.00	441.2	3679	378	1324	4478	357	1785	4761
900/50R42	28.00	253.9	2118	218	762	2578	205	1027	2741
13.6-46	12.00	63.7	531	55	191	646	52	258	687
14.9R46	13.00	80.5	671	69	242	817	65	326	869
18.4R46	16.00	121.9	1016	104	366	1237	99	493	1315
320/90R46	10.00	53.0	442	45	159	538	43	214	572
380/90R46	12.00	81.7	682	70	245	830	66	331	882
IF380/90R46	13.00	79.9	667	69	240	811	65	323	862
VF380/90R46	13.00	79.9	667	69	240	811	65	323	862
420/80R46	13.00	87.5	730	75	262	888	71	354	944
IF420/80R46	13.00	83.9	700	72	252	852	68	339	906
480/80R46 (18.4R46)	16.00	125.4	1046	107	376	1273	101	507	1353
520/85R46	16.00	158.0	1318	135	474	1604	128	639	1705
IF520/85R46	18.00	166.1	1385	142	498	1685	134	672	1792
230/95R48	7.00	26.3	219	23	79	267	21	106	283
320/90R50	10.00	57.3	478	49	172	581	46	232	618
380/90R50	12.00	85.2	711	73	256	865	69	345	920
380/105R50	12.00	111.9	933	96	336	1136	91	453	1208
IF380/105R50	13.00	106.1	885	91	318	1077	86	429	1145
VF380/105R50	13.00	106.1	885	91	318	1077	86	429	1145
480/80R50	15.00	133.8	1116	115	402	1358	108	541	1444
IF480/80R50	16.00	132.9	1109	114	399	1349	108	538	1434
IF480/95R50	16.00	164.6	1372	141	494	1670	133	666	1776
320/90R54	10.00	59.7	498	51	179	606	48	241	644
380/90R54	12.00	92.2	769	79	277	936	75	373	995

RADIAL FARM

BIAS FARM

FRONTS & IMPLEMENTS

FORESTRY & FLOTATION

DISCONTINUED

LOAD & INFLATION TABLES

GENERAL TIRE INFORMATION

WARRANTY

HYDROINFLATION

IMPLEMENT AND FARM TIRES

TIRE SIZE	RIM WIDTH	WATER		3½ LB SOLUTION			5 LB SOLUTION		
		SOLID AT +32° F		SLUSH-FREE TO -12° F			SLUSH-FREE TO -53° F		
		3/4 FILL H ₂ O	H ₂ O WEIGHT	GAL H ₂ O	CaCl ₂ LBS	TOTAL WT.	GAL H ₂ O	CaCl ₂ LBS	TOTAL WT.
7.5-14	5.50	8.6	72	7	26	88	7	35	93
8.5L-14	6.00	10.2	85	9	31	103	8	41	110
9.5L-14	8.00	13.0	108	11	39	132	11	53	140
11L-14	8.00	14.5	121	12	44	147	12	59	157
5.90-15	4.50	5.1	42	4	15	51	4	20	55
5.00-15	3.00	4.3	36	4	13	44	4	18	47
6.70-15	4.50	6.6	55	6	20	67	5	27	72
7.60-15	5.50	8.8	74	8	27	90	7	36	95
9.5L-15	8.00	12.4	103	11	37	126	10	50	134
10.00-15	8.00	19.8	165	17	59	201	16	80	213
11L-15	8.00	14.7	122	13	44	149	12	59	158
12.5L-15	10.00	20.0	167	17	60	203	16	81	216
27x8.50-15	7.00	7.8	65	7	23	79	6	32	84
27x9.50-15	8.00	9.5	80	8	29	97	8	39	103
31x13.50-15	10.00	17.7	147	15	53	179	14	71	191
6.00-16	4.00	6.2	52	5	19	63	5	25	67
7.50-16	5.50	10.7	89	9	32	109	9	43	116
11L-16	8.00	16.0	134	14	48	163	13	65	173
12.5L-16	10.00	20.2	168	17	61	205	16	82	218
13.5-16.1	11.00	36.3	303	31	109	368	29	147	392
14L-16.1	11.00	30.7	256	26	92	312	24	124	331
16.5L-16.1	14.00	43.7	365	37	131	444	35	177	472
19L-16.1	16.00	58.3	487	50	175	592	47	236	630
21.5L-16.1	18.00	76.2	636	65	229	774	62	308	822
36x16-17.5	10.50	29.3	244	25	88	297	24	119	316
36x16B17.5	10.50	29.3	244	25	88	297	24	119	316
40x19B19.5	15.00	38.4	321	33	115	390	31	156	415
7.5-20	5.50	12.3	103	11	37	125	10	50	133
11.25-20	8.00	27.5	230	24	83	280	22	111	297
9.00-24	8.00	28.4	237	24	85	288	23	115	306
11.25-24	10.00	39.8	332	34	119	404	32	161	429
11.25-28	10.00	44.8	374	38	134	455	36	181	484

RADIAL FARM
 BIAS FARM
 FRONTS & IMPLEMENTS
 FORESTRY & FLOTATION
 DISCONTINUED
 LOAD & INFLATION TABLES
 GENERAL TIRE INFORMATION
 WARRANTY



HYDROINFLATION

FRONT TRACTOR TIRES

TIRE SIZE	RIM WIDTH	WATER		3½ LB SOLUTION			5 LB SOLUTION		
		3/4 FILL H ₂ O	SOLID AT +32° F H ₂ O WEIGHT	SLUSH-FREE TO -12° F SOLID AT -52° F		SLUSH-FREE TO -53° F SOLID AT -62° F		TOTAL WT.	
		GAL H ₂ O	CaCl ₂ LBS	TOTAL WT.	GAL H ₂ O	CaCl ₂ LBS	TOTAL WT.		
4.00-9	3.00	2.0	17	2	6	20	2	8	22
4.50-10	3.00	2.4	20	2	7	24	2	10	25
7.5L-15	6.00	9.7	81	8	29	98	8	39	105
9.5L-15	7.00	12.0	100	10	36	122	10	48	129
11L-15	8.00	15.1	126	13	45	153	12	61	163
5.50-16	4.00	5.2	44	4	16	53	4	21	56
6.50-16	4.50	8.2	68	7	25	83	7	33	88
7.50/8.00-16	6.00	12.0	100	10	36	122	10	48	129
7.50-16	5.50	11.3	95	10	34	115	9	46	122
10.00-16	8.00	18.6	155	16	56	188	15	75	200
11.00-16	10.00	26.9	224	23	81	273	22	109	290
11L-16	8.00	15.4	129	13	46	157	12	62	166
14.5/75-16.1	11.00	29.4	245	25	88	299	24	119	318
14L-16.1	11.00	30.7	256	26	92	311	25	124	331
16.5L-16.1	14.00	46.7	389	40	140	474	38	189	504
7.50-18	5.50	12.5	104	11	37	127	10	50	135
7.50-20	5.50	12.2	102	10	37	124	10	49	132
11.00-24	10.00	36.2	302	31	109	368	29	147	391

RADIAL FARM

BIAS FARM

FRONTS & IMPLEMENTS

FORESTRY & FLOTATION

DISCONTINUED

LOAD & INFLATION TABLES

GENERAL TIRE INFORMATION

WARRANTY

HYDROINFLATION

FORESTRY/FLOTATION TIRES

TIRE SIZE	RIM WIDTH	WATER		3½ LB SOLUTION			5 LB SOLUTION		
		SOLID AT +32° F		SLUSH-FREE TO -12° F			SLUSH-FREE TO -53° F		
		3/4 FILL H ₂ O	H ₂ O WEIGHT	GAL H ₂ O	CaCl ₂ LBS	TOTAL WT.	GAL H ₂ O	CaCl ₂ LBS	TOTAL WT.
42x25.00-20	20.50	59.6	497	51	179	605	48	241	643
48x25.00-20	20.50	91.7	765	79	275	930	74	371	989
48x31.00-20	26.00	114.2	952	98	343	1159	92	462	1232
54x37.00B25	32.00	169.8	1416	146	509	1723	137	687	1832
66x43.00-25	36.00	297.4	2480	255	892	3018	241	1203	3209
66x44.00-25	36.00	367.0	3061	315	1101	3725	297	1485	3961
67x34.00B25	30.00	225.3	1879	193	676	2287	182	911	2432
1050/50R25	36.00	308.7	2574	265	926	3133	250	1248	3331
18.4-26	16.00	80.3	670	69	241	815	65	325	866
23.1B26	20.00	137.0	1142	117	411	1390	111	554	1478
28LB26	25.00	172.5	1439	148	518	1751	140	698	1862
57x31.00-26	25.00	168.7	1407	145	506	1712	136	682	1820
66x43.00-26	36.00	287.4	2397	246	862	2917	232	1162	3101
67x34.00-26	30.00	223.3	1863	191	670	2267	181	903	2410
16.9-30	15.00	72.8	607	62	218	739	59	294	785
24.5B32	21.00	169.2	1411	145	508	1717	137	684	1826
30.5LB32	27.00	236.7	1974	203	710	2403	192	958	2555
35.5LB32	31.00	326.7	2724	280	980	3316	264	1321	3525
DH73x44B32	36.00	325.9	2718	279	978	3308	264	1318	3518
VA73x44-32	36.00	350.5	2923	300	1052	3557	284	1418	3782
76x50.00-32	44.00	460.6	3841	395	1382	4675	373	1863	4970
18.4-34	16.00	98.2	819	84	295	997	79	397	1060

METRIC FORESTRY TIRES

TIRE SIZE	RIM WIDTH	WATER		3½ LB SOLUTION			5 LB SOLUTION		
		SOLID AT +32° F		SLUSH-FREE TO -12° F			SLUSH-FREE TO -53° F		
		3/4 FILL H ₂ O	H ₂ O WEIGHT	GAL H ₂ O	CaCl ₂ LBS	TOTAL WT.	GAL H ₂ O	CaCl ₂ LBS	TOTAL WT.
600/55-22.5	20.00	84.0	700	72	252	852	68	340	906
700/50-22.5	24.00	101.4	846	87	304	1029	82	410	1094
600/55B26.5	20.00	85.0	709	73	255	863	69	344	917
700/50B26.5	24.00	101.7	848	87	305	1032	82	411	1097
710/45B26.5	24.00	103.2	861	89	310	1048	84	418	1114
750/55B26.5	24.00	139.6	1164	120	419	1417	113	565	1507
600/65B34	20.00	117.4	979	101	352	1192	95	475	1267
700/55B34	24.00	139.3	1162	119	418	1414	113	564	1504

HYDROINFLATION

LIGHT INDUSTRIAL TIRES

TIRE SIZE	RIM WIDTH	WATER		3½ LB SOLUTION			5 LB SOLUTION		
		SOLID AT +32° F 3/4 FILL H ₂ O	H ₂ O WEIGHT	SLUSH-FREE TO -12° F SOLID AT -52° F		TOTAL WT.	SLUSH-FREE TO -53° F SOLID AT -62° F		TOTAL WT.
		GAL H ₂ O	CaCl ₂ LBS		GAL H ₂ O		CaCl ₂ LBS		
215/65D14	6.00	6.2	52	5	19	63	5	25	67
215/70D15 (27x8.50-15)	7.00	6.9	57	6	21	70	6	28	74
260/65D15 (27x10.50-15)	8.00	8.7	73	7	26	89	7	35	94
390/60D15 (31x15.50-15)	13.00	20.5	171	18	62	208	17	83	221
265/70D16.5 (10-16.5)	8.25	12.0	100	10	36	122	10	49	130
265/70D16.5 SDT	8.25	9.2	77	8	28	93	7	37	99
305/70D16.5 (12-16.5)	9.75	16.6	138	14	50	169	13	67	179
305/70D16.5 SDT	9.75	13.0	109	11	39	132	11	53	140
330/55D16.5 (31x13.0-16.5)	9.75	14.9	124	13	45	151	12	60	160
395/55D16.5 (33x15.5-16.5)	12.00	21.9	183	19	66	222	18	89	236
14-17.5	10.50	26.8	224	23	80	272	22	108	289
355/70D17.5	10.50	24.2	202	21	73	246	20	98	261
10.5/80-18	9.00	18.1	151	16	54	184	15	73	195
12.0/12.5-18	9.00	21.8	182	19	65	221	18	88	235
12.5/80-18	9.00	23.5	196	20	71	239	19	95	254
320/80R18	10.00	23.6	197	20	71	239	19	95	254
340/80R18	11.00	27.6	230	24	83	280	22	112	298
15-19.5	11.75	31.1	259	27	93	315	25	126	335
385/65D19.5	11.75	31.3	261	27	94	318	25	127	338
445/65D19.5	14.00	45.8	382	39	137	464	37	185	494
10.0/10.5-20	9.00	22.0	183	19	66	223	18	89	237
12.5-20	11.00	28.2	235	24	85	286	23	114	305
15-22.5	11.75	34.7	289	30	104	352	28	140	374
385/65D22.5	11.75	34.7	289	30	104	352	28	140	374
445/65D22.5	14.00	50.4	421	43	151	512	41	204	544
14.9-24	13.00	52.0	434	45	156	528	42	210	562
16.9-24	15.00	69.9	583	60	210	710	57	283	754
17.5L-24	15.00	62.0	517	53	186	629	50	251	669
17.5LR24	15.00	60.0	501	51	180	609	49	243	648
18.4-24	16.00	87.2	727	75	262	885	71	353	941
19.5L-24	16.00	77.1	643	66	231	782	62	312	832
21L-24	18.00	95.1	793	82	285	965	77	385	1026
420/70-24	13.00	50.1	418	43	150	508	41	203	541
500/70R24	16.00	74.4	620	64	223	755	60	301	803
14.9-28	13.00	59.8	499	51	179	607	48	242	645
16.9-28	15.00	78.2	652	67	235	794	63	316	844
16.9-28	15.00	75.5	629	65	226	766	61	305	814
18.4-28	16.00	94.9	792	81	285	963	77	384	1024
21L-28	18.00	107.9	900	93	324	1095	87	437	1165

RADIAL FARM

BIAS FARM

FRONTS &
IMPLEMENTS

FORESTRY &
FLOTATION

DISCONTINUED

LOAD & INFLATION
TABLES

GENERAL TIRE
INFORMATION

WARRANTY

WARNING & SAFETY PRECAUTIONS

RMA RECOMMENDED WARNING AND SAFETY PRECAUTIONS

SERIOUS INJURY OR DEATH MAY RESULT FROM:

- EXPLOSION OF TIRE/RIM/WHEEL ASSEMBLY DUE TO IMPROPER MOUNTING — NEVER EXCEED 35 PSI (240 kPa) AIR PRESSURE WHEN SEATING BEADS. ALWAYS USE SAFETY CAGE OR OTHER RESTRAINING DEVICE AND CLIP-ON EXTENSION HOSE. ONLY SPECIALLY TRAINED PEOPLE SHOULD MOUNT TIRES.
- TIRE FAILURE DUE TO MISAPPLICATION/IMPROPER INFLATION/OVERLOADING/EXCEEDING MAXIMUM SPEED — FOLLOW TIRE MANUFACTURER'S INSTRUCTIONS. CHECK INFLATION PRESSURE FREQUENTLY WITH GAUGE.
- EXPLOSION OF THE TIRE/RIM/WHEEL ASSEMBLY DUE TO WELDING THE RIM WITHOUT FIRST REMOVING THE TIRE — NEVER REWORK, WELD, HEAT OR BRAZE THE RIM OF A TIRE/WHEEL/RIM ASSEMBLY.

15.3" DIAMETER; 9" WIDTH EUROPEAN RIMS

Certain European farm implement equipment has been imported into North America with unique diameter rims for which no North American-produced replacement tire sizes are available.

Any attempt to mount and inflate 15" nominal bead diameter tires on these rims may ultimately cause one of the tire beads to break, possibly resulting in serious physical injury or even death.

The rims in question are 15.3" in diameter and 9" wide. However, rims manufactured in 1981 and earlier are marked as 15" diameter; only those manufactured in 1982 and 1983

are marked as 15.3" diameter. The key to avoiding this potentially dangerous situation is the 9" width.

The U.S.A. (or Canada) wheel industry does not manufacture a 9" width rim for farm implement use. The European tire sizes that may be mounted on these rims are:
10.0/75-15.3 (or 15)
11.5/80-15.3 (or 15)
10.5/85-15.3
12.5/80-15.3

U.S.A. (OR CANADA)-PRODUCED FARM IMPLEMENT TIRES ARE NOT TO BE MOUNTED ON ANY 9" WIDE FARM IMPLEMENT RIM.

There is a danger of serious injury or death if a tire of one bead diameter is installed on a rim or wheel of a different rim diameter.

Always replace a tire with another tire of exactly the same bead diameter designation and suffix letters.

For example, a 16" tire goes on a 16" rim. Never mount a 16" tire on a 16.1" or 16.5" rim. A 16.1" tire goes on a 16.1" rim.

Never mount a 16.1" tire on a 16" or 16.5" rim. A 16.5" tire goes on a 16.5" rim. Never mount a 16.5" tire on a 16" or 16.1" rim.

While it is possible to pass a 16" diameter tire over the lip or flange of a 16.1" or 16.5" size diameter rim, it cannot be inflated enough to position itself against the rim flange. If an attempt is made to seat the tire bead by inflating, the tire bead will break with explosive force and could cause serious injury or death.

RADIAL FARM

BIAS FARM

FRONTS &
IMPLEMENT'S

FORESTRY &
FLOTATION

DISCONTINUED

LOAD & INFLATION
TABLES

GENERAL TIRE
INFORMATION

WARRANTY

WARNING & SAFETY PRECAUTIONS

Rims of different diameters and tapers cannot be interchanged. The following diagram illustrates the difference between rims of two different tapers and diameters:

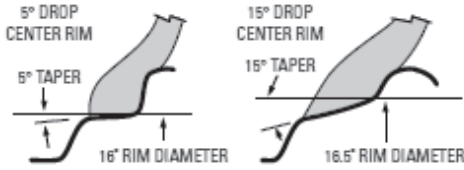

The following diagram shows how beads of a 16" tire will not seat on a 16.5" rim. The beads cannot be forced out against the rim flanges by using more air pressure because this will break the beads, and the tire will explode with force sufficient to cause serious injury or death.



To obtain optimum tire performance, use rims with approved contours. Do not use a rim wider or narrower than recommended. The use of nonapproved rim contours may adversely affect tire life and performance. (See Approved Rim Contours on pages 168-172).

Radial tires may use the same rim contour as the bias tires they replace. However, it is necessary to check with the rim manufacturer to ensure the rims on the vehicle are appropriate for use with radial tires.

Rim dimensions are standardized by The Tire and Rim Association, Inc. for size and contour only, and particular tire and rim combinations are designated to ensure proper mounting and fit of the tire to the rim. The load and cold inflation pressure imposed on the rim and wheel must not exceed the rim and wheel manufacturer's recommendations even though the tire may be approved for a higher load or inflation. Rims and wheels may be identified (stamped) with a maximum load and maximum cold inflation rating. For rims and wheels not so identified or for service conditions exceeding the rated capacities,

consult the rim and wheel manufacturers to determine rim and wheel capacities for the intended service.

TIRE DEMOUNTING AND MOUNTING SAFETY PRECAUTIONS

- Tire changing can be dangerous and should be done by trained personnel using proper tools and procedures. Before servicing tires, always read and understand any manufacturer's warning contained in the customer's literature or molded into the tire sidewall.
- Failure to comply with these procedures may result in faulty positioning of the tire and/or rim parts, and cause the assembly to burst with explosive force, sufficient to cause serious physical injury or death. Never mount or use damaged tires or rims.
- Reinflation of any type of tire/rim assembly that has been operated in a run-flat or underinflated condition (80% or less of recommended pressure), can result in serious injury or death. The tire may be damaged on the inside and can explode while you are adding air. The rim parts may be worn, damaged or dislodged and can explosively separate.
- NEVER rework, weld, heat or braze the tire/wheel/rim. Heating the rim of tire/wheel/rim assembly can cause a tire to explode, causing serious injury or death.
- The use of any flammable material during tire servicing is absolutely prohibited. Use of starting fluid, ether, gasoline or any other flammable material to lubricate, seal or seat the beads of a tubeless tire can cause the tire to explode or can cause the explosive separation of the tire/rim assembly, resulting in serious injury or death.
- NEVER hammer, strike or pry on any type of tire/rim assembly while the tire contains inflation pressure. Do not attempt to seat any part while the tire contains any inflation pressure. This could result in serious injury or death.

RADIAL FARM

BIAS FARM

FRONTS &
IMPLEMENT'S

FORESTRY &
FLOTATION

DISCONTINUED

LOAD & INFLATION
TABLES

GENERAL TIRE
INFORMATION

WARRANTY

WARNING & SAFETY PRECAUTIONS

STAY OUT OF THE TRAJECTORY AS INDICATED BY SHADED AREA.

NOTE: Under some circumstances, the trajectory may deviate from its expected path. Always use a safety cage or other restraining device in compliance with OSHA regulations.

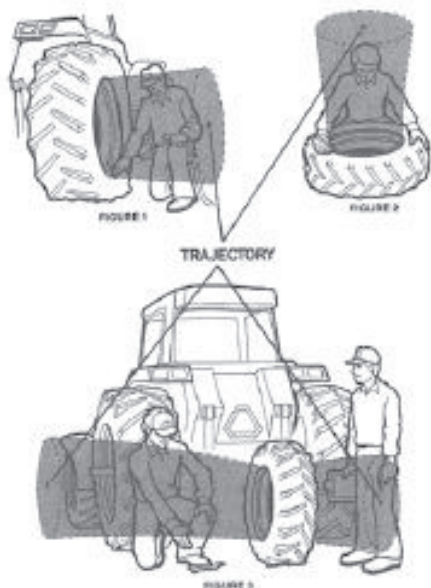

GENERAL SAFETY PRECAUTIONS

1. NEVER re-inflate a tire that has been operated in a run-flat or underinflated condition (80% or less of recommended pressure). Demount and inspect all tire and rim parts before re-inflating.
2. ALWAYS use specialized tools as recommended by tire supplier for mounting and demounting of tires.
3. BEFORE loosening any nuts or clamps that attach a multi-piece rim assembly to a vehicle, always completely deflate the tire (both tires of a dual assembly) by taking out the valve core(s). Never attempt to demount a tire from a rim unless you are sure that the tire is completely deflated. Failure to follow this practice can cause the assembly to burst with force sufficient to cause serious injury or death.
4. NEVER use any rim part that is bent, pitted from corrosion, cracked or worn. These are unserviceable parts and must be destroyed so that they cannot be used. Remove rust, dirt or foreign material from rim parts.
5. NEVER use a rim part unless you can positively identify it from the manufacturer's stamped markings. If you cannot identify a part, it must be destroyed.
6. ALWAYS inspect inside of tire for loose cords, cuts, penetrating objects or other casing damage. Repairable damage must be repaired before placing tire back into service. Tires with unrepairable damage should be destroyed.
7. NEVER substitute an inner tube for a permissible or non-permissible repair.
8. ALWAYS replace a tire with one having the same rim diameter designation and suffix letters.
9. ALWAYS inspect inside of the tire and remove dirt, liquids or other foreign material before mounting.
10. NEVER install tubes that have buckled or creased.
11. ALWAYS use new tubes in new tires.
12. ALWAYS use radial tubes with tube-type radial tires.
13. NEVER use a tube in a casing larger or smaller than that for which the tube was designed by the manufacturer.
14. ALWAYS check to be sure tube is clean before installing in tire.
15. ALWAYS lubricate with only approved tire mounting lubricant or mild vegetable-oil soap solution. Never use anti-freeze, silicones or petroleum-based lubricants. This will damage the tire.
16. ALWAYS inspect valve cores for proper air retention. Replace damaged or leaky cores.
17. ALWAYS inflate tire to tire manufacturer's recommended cold inflation pressure for the tire's intended service.
18. When inflating a tire off a vehicle, use a safety cage or other restraining device and an extension hose with in-line air gauge and clip-on air chuck, which allows the operator to stand clear of the trajectory.
19. For tube-type tires, inflate to service pressure without the valve core installed and then completely deflate the tire to prevent wrinkles in the tube. Insert the valve core and re-inflate the tire to recommended service pressure as specified for the tire and/or rim.
20. ALWAYS use sealing valve caps to prevent loss of air or fluid.
21. ALWAYS check to be sure tire is centered on rim before inflating.

WARNING & SAFETY PRECAUTIONS

MOUNTING

STEP 1: FIGURE A

- Lubricate both beads and rim.
- Position tire so first bead is in wheel well 180° from valve.

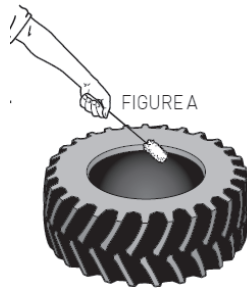

STEP 2: FIGURE B

- Using tire iron or mounting machine, pry the first bead over the rim flange. Start away from the valve.
- Continue to pry the first bead over the rim flange, working your way toward the valve.
- Finish prying the first bead over the rim flange at the valve.

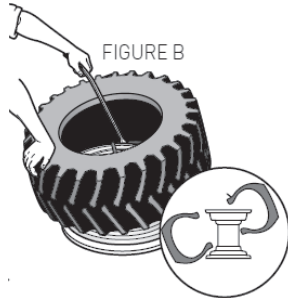

STEP 3: FIGURE C

- Position tire so both beads are in wheel well 180° from valve.
- Using tire iron or mounting machine, pry the second bead over the rim flange. Start away from the valve.
- Continue to pry the second bead over the rim flange, working your way toward the valve.
- Finish prying the second bead over the rim flange at the valve.

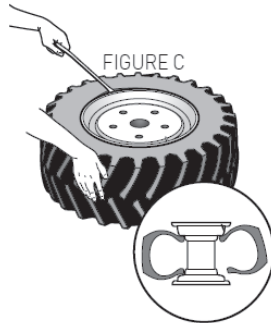

INFLATING

STEP 4: FIGURE D

- Center tire on wheel before inflation.
- Apply remote air chuck to the valve.
- Insert assembly in a small cage or other device to protect personnel.
- Apply air to the tire and wheel assembly.

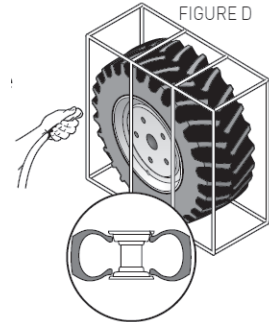

STEP 5: FIGURE E

- Inflate tire to seat the beads.
- Do not inflate over 35 psi (240 kPa) to seat the beads.
- If beads do not seat at 35 psi (240 kPa), reposition tire on wheel and re-lubricate.
- Repeat inflation procedure.
- Set to proper inflation pressure.

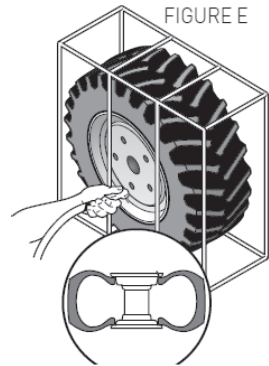

GENERAL INFORMATION

1. Tire mounting and dismounting can be dangerous; use only trained personnel.
2. Use a non-metallic hammer to mount and dismount tire.
3. Use proper tools and equipment.
4. Be sure all components are clean and dry.
5. If a tube is to be used, use only a new tube in a new tire.
6. Lubricate tire beads, rim bead seat and innertube with a vegetable-based lubricant. Do not use petroleum-based or silicone lubricants.
7. To prevent rim-to-tire slip, the lubricant must dry; therefore, dilute the lubricant with water 50%.
8. Mount the tire with the pry notch 90° from the valve.
9. Mount and dismount tires on the side of the rim closest to the drop center.
10. When prying the bead over the rim flange, use small increments.
11. If a tube is used, double inflate to allow the tube to reposition itself.

WARNING & SAFETY PRECAUTIONS

DISMOUNTING

STEP 1: FIGURE F

- Deflate the tire completely.
- Keep open flame away from air evacuating the tire (no smoking, no flames).
- Lubricate the pry notch with approved lubricant.

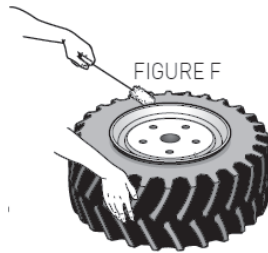

STEP 2: FIGURE G

- Push bead of the bead seat of the wheel with a “bead breaker.”
- Lubricate both beads and rimflange nearest the wheel well.

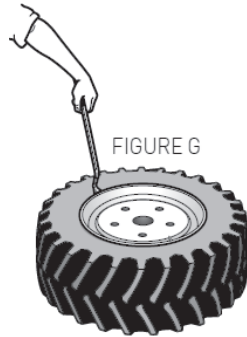

STEP 3: FIGURE H

- Position the beads in the wheel well 180° from the valve.
- Position an iron or mounting machine at the valve.
- Taking small increments, pry the first bead off the wheel.

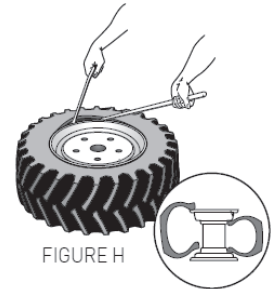

STEP 4: FIGURE I

- Taking small increments, pry the second bead off the wheel, starting at the valve.
- Complete dismounting the bead away from valve.

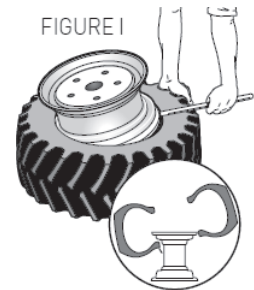

RADIAL FARM

BIAS FARM

FRONTS & IMPLEMENTS

FORESTRY & FLOTATION

DISCONTINUED

LOAD & INFLATION TABLES

GENERAL TIRE INFORMATION

WARRANTY

MEASURING AND CORRECTING LEAD/LAG

MAXIMUM TIRE PERFORMANCE IN THE FIELD

- Lead/Lag — sometimes referred to as overspeed/underspeed — is a condition found in mechanical front-wheel-drive tractors. Lead/lag conditions can shorten the life of the front tires AND cause wear and tear on the tractor's transfer case.
- Lead/Lag refers to the relationship between the speed of the front wheels and the speed of the rear wheels. If the front wheels' speed is faster than the back wheels' speed, we say that the tractor has a lead condition. If the front wheels' speed is slower than the back wheels' speed, the tractor has a lag

condition. And if the front and rear wheels move at the same speed, the tractor would have zero lead/lag. But since front and rear tires are always different sizes, there will always be some amount of lead or lag.

- The desired amount of lead is 2%, which means the front wheels are 2% faster than the rear wheels. Anywhere from 0 to 5% lead is considered acceptable. But no amount of lag is acceptable. A lag condition puts excessive strain on the tractor's transfer case, and it causes the front tires to wear out more quickly than they would under normal operating conditions.

MEASURING THE AMOUNT OF LEAD/LAG ON A MECHANICAL FRONT-WHEEL-DRIVE TRACTOR

Testing for lead/lag is a four-step process that requires three people: one to drive the tractor, one to count the revolutions of the rear wheel, and one to count the revolutions of the front wheel.

1. Mark the tires. Using a piece of chalk, mark both the front and rear tires on one side of the tractor. Draw one line on the side of the rear tire, and ten evenly-spaced lines on the side of the front tire.
2. Find a long, straight piece of ground with firm soil on which to drive the tractor and begin conducting the test. Start with the chalk line on the rear tire pointing straight down. With front wheels engaged, drive the tractor forward. Using the chalk line as a guide, have one person count the number of revolutions of the rear tire and another person count the number of revolutions of the front tire. When the rear tire has made exactly 10 revolutions, stop the tractor and write down the number of revolutions the front tire made, to the nearest tenth of a revolution. To ensure an accurate reading, repeat the procedure at least one more time.
3. With the front wheels in neutral (disengaged), repeat the process. After the rear tire has made ten revolutions, stop the tractor and write down the number of revolutions the front tire made, to the nearest tenth of a revolution. Again, it's a good idea to repeat the procedure at least once to ensure your reading is accurate. When you have accurate

readings with and without the front wheels engaged, you're ready to calculate the percentage of lead or lag.

4. Divide the number of revolutions of the front tire with the front wheels engaged by the number of revolutions of the front tire with the front wheels in neutral, and then subtract one. If the resulting number is greater than zero — a positive number — the tractor has a lead condition. If the resulting number is less than zero — a negative number — the tractor has a lag condition.

Here are two examples. In the first example, suppose the number of revolutions of the front tire engaged was 14.3, and the number of revolutions of the front tire in neutral was 13.8. Dividing 14.3 by 13.8, you get 1.036. Subtract one from 1.036, and you get a positive .04. This means the tractor has 4% lead. In the second example, let's say the number of revolutions of the front tire engaged was 13.3, and the number of revolutions of the front tire in neutral was 13.8. Dividing 13.3 by 13.8, you get .96. Subtract one from .96, and you get a negative .04. This means the tractor has about a 4% lag.

Referring back to our acceptable and unacceptable amounts of lead and lag, you can see that the 4% lead would fall into the acceptable range of 0 to 5%, but the 4% lag is unacceptable and should be corrected.

MEASURING AND CORRECTING LEAD/LAG

CORRECTING LEAD/LAG

To correct lead or lag, change to front tires with a different diameter. If you have a lead condition of more than 5%, you would change to a front tire with a smaller diameter. If you have a lag condition, you'd change to a front tire with a larger diameter. If you have a tractor with 6% lead, use a front that's 4% smaller. If you have 6% lag, use a front that's 8% larger.

A final note. The wear and tear on the front tires and the tractor's transfer case as the result of lead/lag is increased during on-road travel. That's why it's important to always have the front wheels in neutral when the tractor is driven on-road.

RADIAL FARM

BIAS FARM

FRONTS &
IMPLEMENTS

FORESTRY &
FLOTATION

DISCONTINUED

LOAD & INFLATION
TABLES

GENERAL TIRE
INFORMATION

WARRANTY

POWER HOP

HOW TO CONTROL POWER HOP ON MECHANICAL FRONT-WHEEL-DRIVE TRACTORS

RADIAL FARM

To correct lead or lag, change to front tires with a different diameter. If you have a lead condition of more than 5%, you would change to a front tire with a smaller diameter. If you have a lag condition, you'd change to a front tire with a larger diameter. If you have a tractor with 6% lead, use a front that's 4% smaller. If you have 6% lag, use a front that's 8% larger.

BIAS FARM

An important note. The wear and tear on the front tires and the tractor's transfer case as the result of lead/lag is increased during on-road travel. That's why it's important to always have the front wheels in neutral when the tractor is driven on-road.

FRONTS & IMPLEMENTS

Agricultural tire dealers and service personnel should follow the recommended procedures below to reduce or eliminate power hop on mechanical front-wheel-drive tractors.

The overall goal is to reduce or eliminate power hop, which can be done by:

FORESTRY & FLOTATION

- Stiffening the front tires by either increasing tire inflation or adding liquid ballast.
- Softening the rear tires by reducing tire inflation and removing liquid ballast.

Generally, to successfully control power hop, a mechanical front-wheel-drive tractor must be equipped with duals or triples on the rear axle. Front duals or a front axle suspension can also help.

DISCONTINUED

STEP 1:

Check for proper weight distribution. If you find the tractor is not properly ballasted, adjust it according to the manufacturer's ballasting recommendations for weight split, total working weight and wheel slip.

Generally, the weight split will be 35% front, 65% rear. Once the tractor is properly ballasted, proceed to step 2.

STEP 2:

Adjust front and rear tire inflation pressures. Adjust the inflation pressures in both the front AND rear tires as follows. (NOTE: BOTH FRONTS AND REARS NEED TO BE DRY.)

LOAD & INFLATION TABLES

GENERAL TIRE INFORMATION

WARRANTY

Front Radials:

Increase inflation pressure to the maximum load listed in Firestone Data Book.

Front Bias:

Increase 8-ply tires to 30 psi (210 kPa)

Increase 12-ply tires to 36 psi (250 kPa)

Rears:

Set both radial and bias tires to the minimum pressure required to carry the axle load.

Check the tractor for hop and performance. If power hop has been eliminated, no further adjustments are necessary. If power hop still persists and the front tires are dry, proceed to step 3.

STEP 3:

Check for proper weight distribution. If you find the tractor is not properly ballasted, adjust it according to the manufacturer's ballasting recommendations for weight split, total working weight and wheel slip.

Remove all front ballast weights. Keep tire pressures the same as in the previous step. Check the tractor for hop and performance. If power hop persists, proceed to step 4.

STEP 4:

Add liquid ballast to front tires ONLY. Using the appropriate equipment, install liquid ballast in ALL the front tires to 75% (normal) fill. The tire is 75% filled when the valve stem is in the 12 o'clock position. (Note: Keep rear tires dry.)

Check the tractor again for hop and performance.

If the power hop is still present, contact Firestone Ag Field Engineering at 1-800-847-3364.

IMPORTANT:

When you are done in the field, make sure to adjust the front tires back to normal psi pressure.

POWER HOP

HOW TO CONTROL POWER HOP ON FOUR-WHEEL-DRIVE TRACTORS

Agricultural tire dealers and service personnel should follow this recommended step-by-step procedure, including how to determine minimum tire inflation pressure, to reduce or eliminate power hop on four-wheel-drive tractors.

The overall goals in controlling power hop on four-wheel-drive tractor pulling implements are:

- Having a tractor with as close to a 51% front and 49% rear static weight split as possible.
- Having tire inflation set to the lowest pressure that will carry the static axle load.

To accomplish this, you will need to soften the tire spring rate and/or alter the static weight split.

It is not possible to control power hop if the tractor is not equipped with duals or triples on both axles.

STEP 1:

Determine the correct axle weight. Check for proper weight distribution. Get as close to 51% front and 49% rear as possible.

Remove any suitcase weights from the front and add them to the rear, if possible. The front tires must be dry. If needed, hydro-inflate ALL the rear tires to 38% fill (4 o'clock or 8 o'clock position) to get the correct weight distribution.

STEP 2:

Match inflation to the load on ALL tires. Set the inflation pressure on all tires, fronts and rears, to the minimum value needed to carry the static axle load. The individual tire load is determined by dividing the static axle load by the number of tires on the axle.

Check the tractor for hop and performance. If power hop persists, proceed to step 3.

STEP 3:

Add 6 psi (40 kPa) to the rear tires only.

Check the tractor for hop and performance. If power hop persists, proceed to step 4.

STEP 4:

Add 6 psi (40 kPa) more to the rear tires only.

Check the tractor for hop and performance again.

If power hop is still present, contact Firestone Ag Field Engineering at 1-800-847-3364.

IMPORTANT:

When you are done in the field, make sure to adjust the front tires back to normal psi pressure.

RADIAL FARM

BIAS FARM

FRONTS &
IMPLEMENTS

FORESTRY &
FLOTATION

DISCONTINUED

LOAD & INFLATION
TABLES

GENERAL TIRE
INFORMATION

WARRANTY

COMMERCIAL LIMITED WARRANTY

FOR FIRESTONE RADIAL AGRICULTURAL TIRES LIMITED WARRANTY – EFFECTIVE JUNE 1, 2018

TIRES COVERED

This Limited Warranty covers all original-tread Firestone brand radial agricultural tires, including "Destination Farm" and "Destination Turf" tires but *excluding* "Performer EVO" tires, purchased or manufactured after June 1, 2018 (except tires made for or used in pulling contests), if they are used in normal agricultural service. It does not cover tires marked "NO ADJ" or "NA" (non-adjustable) or tires not containing the Firestone serial number. Tires branded DT (damaged tire) are not adjustable for appearance. Tires are adjustable for ride-related conditions only during the first six months of service and up to 1/32nd of an inch of tread wear.

WHAT IS WARRANTIED

If, before wearing down to 2/32nds of an inch of tread or bar depth remaining, any tire covered by this Limited Warranty becomes unusable for any reason within the manufacturer's control, such tire will be replaced with an equivalent new Firestone tire on the basis set forth in the section titled "Limited Warranty Period and Pro Rata Percentages" on the following page. Some examples of causes or conditions normally beyond the manufacturer's control are:

1. Field or road hazards or stubble damage (e.g., cut, snag, puncture, stubble damage, impact break, tear or chunk in tread, bar or shoulder);
2. Apparent overload or improper inflation pressure or abuse;
3. Wheel misalignment, rim slip, tire/wheel assembly imbalance, mismatching of adjacent tires, or other vehicle conditions, defects or characteristics;
4. Conditions caused by land-leveling or earth-moving operations;
5. Improper repair or improper insertion of sealant, balancing or filler materials;
6. Intentional alteration of either the appearance or the physical characteristics of the tire;
7. Mounting damage or conditions caused by aging or improper storage; and
8. Failure to observe any of the "Owner-User's Obligations" items listed elsewhere in this publication.

This Limited Warranty is in addition to, and/or may be limited by, any other applicable written warranty you may have received concerning special tires or situations.

LIMITED WARRANTY PERIOD AND PRO RATA PERCENTAGES

During the first two years of service (proof-of-purchase must be attached to claim form), if the tire is worn less than 25%,

the tire will be replaced without charge including normal mounting and service charges.

After the free replacement period, the replacement price will be prorated based on years of service from the original purchase date (proof-of-purchase must be attached to claim form, or if proof-of-purchase is not available or if tire was not purchased new, then based on years from date of manufacture, which is molded into the sidewall of the tire), as set forth per the following:

Years of service or age during	If worn less than	Pro-rata collection
3rd Year	30%	30%
4th Year	40%	40%
5th Year	50%	50%
6th Year	60%	60%
7th Year	70%	70%
8th Year	80%	80%
9th Year	90%	90%
After the end of the 9th year, coverage expires		100%

To determine the replacement price, the appropriate pro rata percentage is multiplied by the Firestone owner-user's regular buying price. Appropriate taxes, mounting or other service charges will be added to the replacement price.

CONDITIONS AND EXCLUSIONS

To the extent permitted by law, Bridgestone Americas Tire Operations, LLC disclaims all warranties, express or implied, other than the warranties stated in this Limited Warranty, including but not limited to the implied warranties of merchantability and fitness for a particular purpose.

TO THE EXTENT PERMITTED BY LAW, BRIDGESTONE AMERICAS TIRE OPERATIONS, LLC DISCLAIMS LIABILITY FOR ANY SPECIAL, INCIDENTAL, CONSEQUENTIAL AND PUNITIVE DAMAGES, LOSS OF TIME OR PROFITS, LOSS OF VEHICLE USE, OR INCONVENIENCE, EVEN IF ADVISED OF THE POSSIBILITY OF SUCH LOSS OR DAMAGES.

Some states do not allow the exclusion or limitation of incidental or consequential damages, so this limitation or exclusion may not apply to you. Only the actual owner-user of the covered tires may make an adjustment claim under this Limited Warranty and Commercial Adjustment Policy, and only for tires used in the 50 United States and the District of Columbia.

RADIAL FARM

BIAS FARM

FRONTS & IMPLEMENTS

FORESTRY & FLOTATION

DISCONTINUED

LOAD & INFLATION TABLES

GENERAL TIRE INFORMATION

WARRANTY

COMMERCIAL LIMITED WARRANTY

FOR FIRESTONE RADIAL AGRICULTURAL TIRES LIMITED WARRANTY – EFFECTIVE JUNE 1, 2018

Nothing in this Limited Warranty is intended to be a representation that failures cannot occur.

OWNER-USER'S OBLIGATIONS

Proper tire care is necessary to obtain maximum hours of usage and wear. The owner-user's obligations are to operate tires within tire load and speed limits (at cold-air pressures specified by Bridgestone Americas Tire Operations, LLC for load and speed according to individual tire size, type and load capacity) and to maintain proper alignment of wheels.

In case of an adjustment claim, the owner-user must present the tire to an authorized Firestone dealer or store,

complete and sign the customer section of the adjustment claim form, attach to the claim form a copy of the proof-of-purchase showing the date the tire was purchased new or proof-of-purchase of the new agricultural equipment that the tire came on, and pay the appropriate replacement price, taxes and service charges for a new, current, equivalent Firestone brand tire.

The obligation of Bridgestone Americas Tire Operations, LLC under this Limited Warranty and Commercial Adjustment Policy may not be enlarged or altered by anyone.

RADIAL FARM

BIAS FARM

FRONTS &
IMPLEMENTS

FORESTRY &
FLOTATION

DISCONTINUED

LOAD & INFLATION
TABLES

GENERAL TIRE
INFORMATION

WARRANTY

COMMERCIAL LIMITED WARRANTY

FOR FIRESTONE PERFORMER EVO RADIAL AGRICULTURAL TIRES LIMITED WARRANTY – EFFECTIVE JUNE 1, 2018

TIRES COVERED

This Limited Warranty covers original-tread Firestone brand radial agricultural tires under “Performer EVO” name, purchased or manufactured after June 1, 2018, if they are used in normal agricultural service. It does not cover tires marked “NO ADJ” or “NA” (non-adjustable) or tires not containing the Firestone serial number. Tires branded DT (damaged tire) are not adjustable for appearance. Tires are adjustable for ride-related conditions only during the first six months of service and up to 1/32nd of an inch of tread wear.

WHAT IS WARRANTIED

If, before wearing down to 2/32nds of an inch of tread or bar depth remaining, any tire covered by this Limited Warranty becomes unusable for any reason within the manufacturer’s control, such tire will be replaced with an equivalent new Firestone tire on the basis set forth in the section titled “Limited Warranty Period and Pro Rata Percentages” on the following page. Some examples of causes or conditions normally beyond the manufacturer’s control are:

1. Field or road hazards or stubble damage (e.g., cut, snag, puncture, stubble damage, impact break, tear or chunk in tread, bar or shoulder);
2. Apparent overload or improper inflation pressure or abuse;
3. Wheel misalignment, rim slip, tire/wheel assembly imbalance, mismatching of adjacent tires, or other vehicle conditions, defects or characteristics;
4. Conditions caused by land-leveling or earth-moving operations;
5. Improper repair or improper insertion of sealant, balancing or filler materials;
6. Intentional alteration of either the appearance or the physical characteristics of the tire;
7. Mounting damage or conditions caused by aging or improper storage; and
8. Failure to observe any of the "Owner-User's Obligations" items listed elsewhere in this publication.

This Limited Warranty is in addition to, and/or may be limited by, any other applicable written warranty you may have received concerning special tires or situations.

LIMITED WARRANTY PERIOD AND PRO RATA PERCENTAGES

During the first year of service (proof-of-purchase must be attached to claim form), if the tire is worn less than 10%, the tire will be replaced without charge including normal mounting and service charges.

After the free replacement period, the replacement price will be prorated based on years of service from the original purchase date (proof-of-purchase must be attached to claim form, or if proof-of-purchase is not available or if tire was not purchased new, then based on years from date of manufacture, which is molded into the sidewall of the tire), as set forth per the following:

Years of service or age during	If worn less than	Pro-rata collection
2nd Year	20%	20%
3rd Year	30%	30%
4th Year	60%	60%
5th Year	80%	80%
6th Year	90%	90%
After the end of the 6th year, coverage expires		100%

To determine the replacement price, the appropriate pro rata percentage is multiplied by the Firestone owner-user’s regular buying price. Appropriate taxes, mounting or other service charges will be added to the replacement price.

CONDITIONS AND EXCLUSIONS

To the extent permitted by law, Bridgestone Americas Tire Operations, LLC disclaims all warranties, express or implied, other than the warranties stated in this Limited Warranty, including but not limited to the implied warranties of merchantability and fitness for a particular purpose.

TO THE EXTENT PERMITTED BY LAW, BRIDGESTONE AMERICAS TIRE OPERATIONS, LLC DISCLAIMS LIABILITY FOR ANY SPECIAL, INCIDENTAL, CONSEQUENTIAL AND PUNITIVE DAMAGES, LOSS OF TIME OR PROFITS, LOSS OF VEHICLE USE, OR INCONVENIENCE, EVEN IF ADVISED OF THE POSSIBILITY OF SUCH LOSS OR DAMAGES.

Some states do not allow the exclusion or limitation of incidental or consequential damages, so this limitation or exclusion may not apply to you. Only the actual owner-user of the covered tires may make an adjustment claim under this Limited Warranty and Commercial Adjustment Policy, and only for tires used in the 50 United States and the District of Columbia.

Nothing in this Limited Warranty is intended to be a representation that failures cannot occur.

OWNER-USER’S OBLIGATIONS

RADIAL FARM

BIAS FARM

FRONTS & IMPLEMENTS

FORESTRY & FLOTATION

DISCONTINUED

LOAD & INFLATION TABLES

GENERAL TIRE INFORMATION

WARRANTY

COMMERCIAL LIMITED WARRANTY

FOR FIRESTONE PERFORMER EVO RADIAL AGRICULTURAL TIRES LIMITED WARRANTY – EFFECTIVE JUNE 1, 2018

RADIAL FARM

Proper tire care is necessary to obtain maximum hours of usage and wear. The owner-user's obligations are to operate tires within tire load and speed limits (at cold-air pressures specified by Bridgestone Americas Tire Operations, LLC for load and speed according to individual tire size, type and load capacity) and to maintain proper alignment of wheels.

BIAS FARM

In case of an adjustment claim, the owner-user must present the tire to an authorized Firestone dealer or store, complete and sign the customer section of the adjustment

claim form, attach to the claim form a copy of the proof-of-purchase showing the date the tire was purchased new or proof-of-purchase of the new agricultural equipment that the tire came on, and pay the appropriate replacement price, taxes and service charges for a new, current, equivalent Firestone brand tire.

The obligation of Bridgestone Americas Tire Operations, LLC under this Limited Warranty and Commercial Adjustment Policy may not be enlarged or altered by anyone.

FRONTS &
IMPLEMENTS

FORESTRY &
FLOTATION

DISCONTINUED

LOAD & INFLATION
TABLES

GENERAL TIRE
INFORMATION

WARRANTY

COMMERCIAL LIMITED WARRANTY

FOR FIRESTONE BIAS-PLY AGRICULTURAL TIRES LIMITED WARRANTY – EFFECTIVE JUNE 1, 2018

TIRES COVERED

This Limited Warranty covers all original-tread Firestone brand bias-ply agricultural tires, including rears, floats, fronts and implements, purchased or manufactured *after June 1, 2018* (except tires made for or used in pulling contests), if they are used in normal agricultural service. It does not cover tires marked “NO ADJ” or “NA” (non-adjustable) or tires not containing the Firestone serial number. Tires branded DT (damaged tire) are not adjustable for appearance. Tires are adjustable for ride-related conditions only during the first six months of service and up to 1/32nd of an inch of tread wear.

WHAT IS WARRANTIED

If, before wearing down to 2/32nds of an inch of tread or bar depth remaining, any tire covered by this Limited Warranty becomes unusable for any reason within the manufacturer’s control, such tire will be replaced with an equivalent new Firestone tire on the basis set forth in the section titled “Limited Warranty Period and Pro Rata Percentages” on the following page. Some examples of causes or conditions normally beyond the manufacturer’s control are:

1. Field or road hazards or stubble damage (e.g., cut, snag, puncture, stubble damage, impact break, tear or chunk in tread, bar or shoulder);
2. Apparent overload or improper inflation pressure or abuse;
3. Wheel misalignment, rim slip, tire/wheel assembly imbalance, mismatching of adjacent tires, or other vehicle conditions, defects or characteristics;
4. Conditions caused by land-leveling or earth-moving operations;
5. Improper repair or improper insertion of sealant, balancing or filler materials;
6. Intentional alteration of either the appearance or the physical characteristics of the tire;
7. Mounting damage or conditions caused by aging or improper storage; and
8. Failure to observe any of the "Owner-User's Obligations" items listed elsewhere in this publication.

This Limited Warranty is in addition to, and/or may be limited by, any other applicable written warranty you may have received concerning special tires or situations.

LIMITED WARRANTY PERIOD AND PRO RATA PERCENTAGES

During the first year of service (proof-of-purchase must be attached to claim form), if the tire is worn less than 10%, the tire will be replaced without charge including normal mounting and service charges.

After the free replacement period, the replacement price will be prorated based on years of service from the original purchase date (proof-of-purchase must be attached to claim form, or if proof-of-purchase is not available or if tire was not purchased new, then based on years from date of manufacture, which is molded into the sidewall of the tire), as set forth per the following:

Years of service or age during	If worn less than	Pro-rata collection
2nd Year	20%	20%
3rd Year	30%	30%
4th Year	60%	60%
5th Year	80%	80%
6th Year	90%	90%
After the end of the 6th year, coverage expires		100%

To determine the replacement price, the appropriate pro rata percentage is multiplied by the Firestone owner-user’s regular buying price. Appropriate taxes, mounting or other service charges will be added to the replacement price.

CONDITIONS AND EXCLUSIONS

To the extent permitted by law, Bridgestone Americas Tire Operations, LLC disclaims all warranties, express or implied, other than the warranties stated in this Limited Warranty, including but not limited to the implied warranties of merchantability and fitness for a particular purpose.

TO THE EXTENT PERMITTED BY LAW, BRIDGESTONE AMERICAS TIRE OPERATIONS, LLC DISCLAIMS LIABILITY FOR ANY SPECIAL, INCIDENTAL, CONSEQUENTIAL AND PUNITIVE DAMAGES, LOSS OF TIME OR PROFITS, LOSS OF VEHICLE USE, OR INCONVENIENCE, EVEN IF ADVISED OF THE POSSIBILITY OF SUCH LOSS OR DAMAGES.

Some states do not allow the exclusion or limitation of incidental or consequential damages, so this limitation or exclusion may not apply to you. Only the actual owner-user of the covered tires may make an adjustment claim under this Limited Warranty and Commercial Adjustment Policy, and only for tires used in the 50 United States and the District of Columbia.

Nothing in this Limited Warranty is intended to be a representation that failures cannot occur.

RADIAL FARM

BIAS FARM

FRONTS & IMPLEMENTS

FORESTRY & FLOTATION

DISCONTINUED

LOAD & INFLATION TABLES

GENERAL TIRE INFORMATION

WARRANTY

COMMERCIAL LIMITED WARRANTY

FOR FIRESTONE BIAS-PLY AGRICULTURAL TIRES LIMITED WARRANTY – EFFECTIVE JUNE 1, 2018

OWNER-USER'S OBLIGATIONS

Proper tire care is necessary to obtain maximum hours of usage and wear. The owner-user's obligations are to operate tires within tire load and speed limits (at cold-air pressures specified by Bridgestone Americas Tire Operations, LLC for load and speed according to individual tire size, type and load capacity) and to maintain proper alignment of wheels.

In case of an adjustment claim, the owner-user must present the tire to an authorized Firestone dealer or store, complete and sign the customer section of the adjustment

claim form, attach to the claim form a copy of the proof-of-purchase showing the date the tire was purchased new or proof-of-purchase of the new agricultural equipment that the tire came on, and pay the appropriate replacement price, taxes and service charges for a new, current, equivalent Firestone brand tire.

The obligation of Bridgestone Americas Tire Operations, LLC under this Limited Warranty and Commercial Adjustment Policy may not be enlarged or altered by anyone.

RADIAL FARM

BIAS FARM

FRONTS &
IMPLEMENTS

FORESTRY &
FLOTATION

DISCONTINUED

LOAD & INFLATION
TABLES

GENERAL TIRE
INFORMATION

WARRANTY

COMMERCIAL LIMITED WARRANTY

FOR FIRESTONE FORESTRY TIRES LIMITED WARRANTY – EFFECTIVE JUNE 1, 2018

TIRES COVERED

This Limited Warranty covers original-tread Firestone brand logger service and wire-tread ply tires if they are used in normal logging service. It does not cover tires marked “NO ADJ” or “NA” (non-adjustable), or tires not containing the Firestone serial number. Tires branded DT (damaged tire) are not adjustable for appearance.

WHAT IS WARRANTIED

If, before wearing down to 2/32nds of an inch of tread or bar depth remaining, and before the end of the fifth year of service (proof-of-purchase required) or before the end of the fifth year from date of manufacture (date molded in sidewall of tire), any tire covered by this Limited Warranty becomes unusable for any reason within the manufacturer’s control, such tire will be replaced with an equivalent new Firestone tire on the basis set forth in the section titled “Replacement Price” below. Some examples of causes or conditions normally beyond the manufacturer’s control are:

1. Forest or road hazards (e.g., cut, snag, puncture, impact, bruise break, stone drill, projection rub, tear or chunk in tread, bar or shoulder);
2. Apparent overload or improper inflation pressure;
3. Wheel misalignment, rim slip, tire/wheel assembly imbalance, mismatching of adjacent tires, other vehicle conditions, defects or characteristics;
4. Improper repair or improper insertion of sealant, or improper balancing of filler materials;
5. Intentional alteration of either the appearance or the physical characteristics of the tire;
6. Conditions caused by aging, improper storage or severe service;
7. Failure to observe any of the "Owner User's Obligations" items listed elsewhere in this publication; and
8. Mounting damage or other abuse.

For logger tires used in normal logging service, this Limited Warranty ends at the end of the fifth year of service if proof-of-purchase is available, or at the end of the fifth year from date of manufacture if no proof-of-purchase is available.

For logger tires used in earth-moving service, this Limited Warranty ends after the fifth year of service if proof-of-purchase is available, or at the end of the fifth year from date of manufacture if no proof-of-purchase is available.

This Limited Warranty is in addition to, and/or may be limited by, any other applicable written warranty you may have received concerning special tires or situations.

REPLACEMENT PRICE

Tires adjusted under this Limited Warranty will be replaced free of charge (except for mounting and service fees) during the first 10% of tread wear; thereafter, to determine the replacement price, the percent of tread wear is multiplied by the owner-user’s regular buying price. Taxes, mounting fees or other service charges will be added to the replacement price.

CONDITIONS AND EXCLUSIONS

To the extent permitted by law, Bridgestone Americas Tire Operations, LLC disclaims all warranties, express or implied, other than the warranties stated in this Limited Warranty, including but not limited to the implied warranties of merchantability and fitness for a particular purpose.

TO THE EXTENT PERMITTED BY LAW, BRIDGESTONE AMERICAS TIRE OPERATIONS, LLC DISCLAIMS LIABILITY FOR ANY SPECIAL, INCIDENTAL, CONSEQUENTIAL AND PUNITIVE DAMAGES, LOSS OF TIME OR PROFITS, LOSS OF VEHICLE USE, AND INCONVENIENCE, EVEN IF ADVISED OF THE POSSIBILITY OF SUCH LOSS OR DAMAGES.

Some states do not allow the exclusion or limitation of incidental or consequential damages, so the above limitation or exclusion may not apply to you.

Only the actual owner-user of the covered tires may make an adjustment claim under this Limited Warranty and Commercial Adjustment Policy, and only for tires used in the 50 United States and the District of Columbia.

Nothing in this Limited Warranty is intended to be a representation that failure cannot occur.

OWNER-USER'S OBLIGATIONS

Proper tire care is necessary to obtain maximum hours of usage and wear.

The owner-user’s obligations are to operate tires within tire load and speed limits (at cold-air pressures specified by Bridgestone Americas Tire Operations, LLC for load and speed according to individual tire size, type and load capacity) and to maintain proper alignment of wheels.

In case of an adjustment claim, the owner-user must present the tire to an authorized Firestone forestry dealer or store, complete and sign the customer section of the adjustment claim form, attach to the claim form a copy of the proof-of-purchase showing the date the tire was purchased new or proof-of-purchase of the new logger equipment that the tire came on, and pay the appropriate replacement price, taxes and service charges for a new, current, equivalent Firestone brand tire.

RADIAL FARM

BIAS FARM

FRONTS &
IMPLEMENTS

FORESTRY &
FLOTATION

DISCONTINUED

LOAD & INFLATION
TABLES

GENERAL TIRE
INFORMATION

WARRANTY

COMMERCIAL LIMITED WARRANTY

FOR FIRESTONE FORESTRY TIRES LIMITED WARRANTY – EFFECTIVE JUNE 1, 2018

The obligation of Bridgestone Americas Tire Operations, LLC under this Limited Warranty and Commercial Adjustment Policy may not be enlarged or altered by anyone.

RADIAL FARM

BIAS FARM

FRONTS &
IMPLEMENTENTS

FORESTRY &
FLOTATION

DISCONTINUED

LOAD & INFLATION
TABLES

GENERAL TIRE
INFORMATION

WARRANTY

STUBBLE DAMAGE POLICY

FOR FIRESTONE RADIAL AND BIAS TIRES

TIRES COVERED

The Firestone Stubble Damage Policy covers all qualified Firestone brand radial and bias rears (R-1, R-1W, R-2, R-3), as well as “Stubble Stomper” and “Destination Branded” agricultural tires purchased new or manufactured after January 1, 2009 and used in normal agricultural service. This Stubble Damage Policy does not cover tires marked “NO ADJ” or “NA” (non-adjustable), tires made for or used in pulling contests, or tires not bearing the Firestone serial number.

POLICY CONDITIONS

Only the original purchaser of the covered tire or of the agricultural equipment the tire came on may make an adjustment claim under this Stubble Damage Policy. If, in normal agricultural service, a Firestone tire covered by this Stubble Damage Policy becomes unusable or not repairable due to stubble damage, such tire will be replaced with an equivalent new Firestone tire on a pro rata basis, as set forth on the following page. You must pay as a replacement price the appropriate pro rata percentage of the owner-user’s regular buying price. You must also pay for mounting, service charges and applicable taxes.

This Stubble Damage Policy is a statement of adjustment policy coverage only. Nothing in this Stubble Damage Policy is intended to be a warranty against stubble damage or representation that failures cannot occur. Bridgestone Americas Tire Operations, LLC disclaims all warranties, express or implied, in respect of stubble damage, including but not limited to the implied warranties of merchantability and fitness for a particular purpose.

STUBBLE DAMAGE POLICY AND PRO RATA PERCENTAGES

The replacement price will be prorated based on years of service based on proof-of-purchase date as follows:

Years of service or age during	If worn less than	Pro-rata collection
1st Year	25%	25%
2nd Year	50%	50%
3rd Year	75%	75%
After the end of the 3rd year, coverage expires		100%

To determine the replacement price, the appropriate pro rata percentage is multiplied by the Firestone owner-user’s regular buying price. Appropriate taxes, mounting, or other service charges will be added to the replacement price.

POLICY EXCLUSIONS

TO THE EXTENT PERMITTED BY LAW, BRIDGESTONE AMERICAS TIRE OPERATIONS, LLC DISCLAIMS LIABILITY FOR ANY SPECIAL, INCIDENTAL, CONSEQUENTIAL AND PUNITIVE DAMAGES, LOSS OF TIME OR PROFITS, LOSS

OF VEHICLE USE, OR INCONVENIENCE, EVEN IF ADVISED OF THE POSSIBILITY OF SUCH LOSS OR DAMAGES.

Some states do not allow the exclusion or limitation of incidental or consequential damages, so this limitation or exclusion may not apply to you.

This Stubble Damage Policy does not cover broken beads, damage due to run flat, abuse, land leveling, vehicle projection, accident, collision, fire or vandalism. Only the original owner-user of the covered tires may make an adjustment claim under this Stubble Damage Policy, and only for tires used in the 50 United States and the District of Columbia.

OWNER-USER’S OBLIGATIONS

The owner-user’s obligations are to operate tires within tire load and speed limits (at cold-air pressures specified by Bridgestone Americas Tire Operations, LLC for load and speed according to individual tire size, type and load capacity) and to maintain proper alignment of wheels. To reduce stubble damage, the owner-user must:

1. Set the tire spacing to run between rows — not on stubble;
2. Use mechanical devices readily available through equipment manufacturers to knock down stubble;
3. Make first tillage pass parallel to the rows.

In case of an adjustment claim, the owner-user must present the tire to an authorized Firestone dealer or store, complete and sign the customer section of the adjustment claim form, attach to the claim form a copy of the proof-of-purchase showing the date the tire was purchased new, or proof-of-purchase of the new agricultural equipment that the tire came on, and pay the appropriate replacement price, taxes, mounting and service charges for a new, current, equivalent Firestone brand tire.

The obligation of Bridgestone Americas Tire Operations, LLC under this Stubble Damage Policy may not be enlarged or altered by anyone.

FIELD HAZARD POLICY

FOR FIRESTONE RADIAL AND BIAS TIRES

RADIAL FARM

BIAS FARM

FRONTS &
IMPLEMENTS

FORESTRY &
FLOTATION

DISCONTINUED

LOAD & INFLATION
TABLES

GENERAL TIRE
INFORMATION

WARRANTY

TIRES COVERED

The Firestone Field Hazard Policy covers all qualified Firestone brand radial and bias rears (R-1, R-1W, R-2, R-3), as well as “Stubble Stomper” and “Destination Branded” agricultural tires purchased new or manufactured after January 1, 2009 and used in normal agricultural service. This Field Hazard Policy does not cover tires marked “NO ADJ” or “NA” (nonadjustable), tires made for or used in pulling contests, or tires not bearing the Firestone serial number.

POLICY CONDITIONS

Only the original purchaser of the covered tire or of the agricultural equipment the tire came on may make an adjustment claim under this Field Hazard Policy. If, in normal agricultural service, a Firestone tire covered by this Field Hazard Policy becomes unusable or not repairable due to field hazard, such tire will be replaced with an equivalent new Firestone tire on a pro rata basis, as set forth on the following page. You must pay as a replacement price the appropriate pro rata percentage of the owner user’s regular buying price. You must also pay for mounting, service charges and applicable taxes.

This Field Hazard Policy is a statement of adjustment policy coverage only. Nothing in this Field Hazard Policy is intended to be a warranty against field hazards or a representation that failures cannot occur. Bridgestone Americas Tire Operations, LLC disclaims all warranties, express or implied, in respect of field hazards, including but not limited to the implied warranties of merchantability and fitness for a particular purpose.

FIELD HAZARD POLICY AND PRO RATA PERCENTAGES

The replacement price will be prorated based on years of service based on proof-of-purchase date as follows:

Years of service or age during	If worn less than	Pro-rata collection
1st Year	25%	50%
2nd Year	50%	75%

After the end of the 3rd year, coverage expires 100%

To determine the replacement price, the appropriate pro rata percentage is multiplied by the Firestone owner-user’s regular buying price. Appropriate taxes, mounting, or other service charges will be added to the replacement price.

POLICY EXCLUSIONS

TO THE EXTENT PERMITTED BY LAW, BRIDGESTONE AMERICAS TIRE OPERATIONS, LLC DISCLAIMS LIABILITY FOR ANY SPECIAL, INCIDENTAL, CONSEQUENTIAL AND PUNITIVE DAMAGES, LOSS OF TIME OR PROFITS, LOSS OF VEHICLE USE, OR INCONVENIENCE, EVEN IF ADVISED OF THE POSSIBILITY OF SUCH LOSS OR DAMAGES.

Some states do not allow the exclusion or limitation of incidental or consequential damages, so this limitation or exclusion may not apply to you.

This Field Hazard Policy does not cover broken beads, damage due to run flat, abuse, land leveling, vehicle projection, accident, collision, fire or vandalism. Only the original owner-user of the covered tires may make an adjustment claim under this Field Hazard Policy, and only for tires used in the 50 United States and the District of Columbia.

OWNER-USER’S OBLIGATIONS

The owner-user’s obligations are to operate tires within tire load and speed limits (at cold-air pressures specified by Bridgestone Americas Tire Operations, LLC for load and speed according to individual tire size, type and load capacity) and to maintain proper alignment of wheels.

In case of an adjustment claim, the owner-user must present the tire to an authorized Firestone dealer or store, complete and sign the customer section of the adjustment claim form, attach to the claim form a copy of the proof-of-purchase showing the date the tire was purchased new or proof-of-purchase of the new agricultural equipment that the tire came on, and pay the appropriate replacement price, taxes, mounting and service charges for a new, current, equivalent Firestone brand tire.

The obligation of Bridgestone Americas Tire Operations, LLC under this Field Hazard Policy may not be enlarged or altered by anyone.

Firestone



FirestoneAG.com

D-403-1