

— Firestone —

# TRUCK TIRE DATA BOOK

2024 | VERSION 24.1

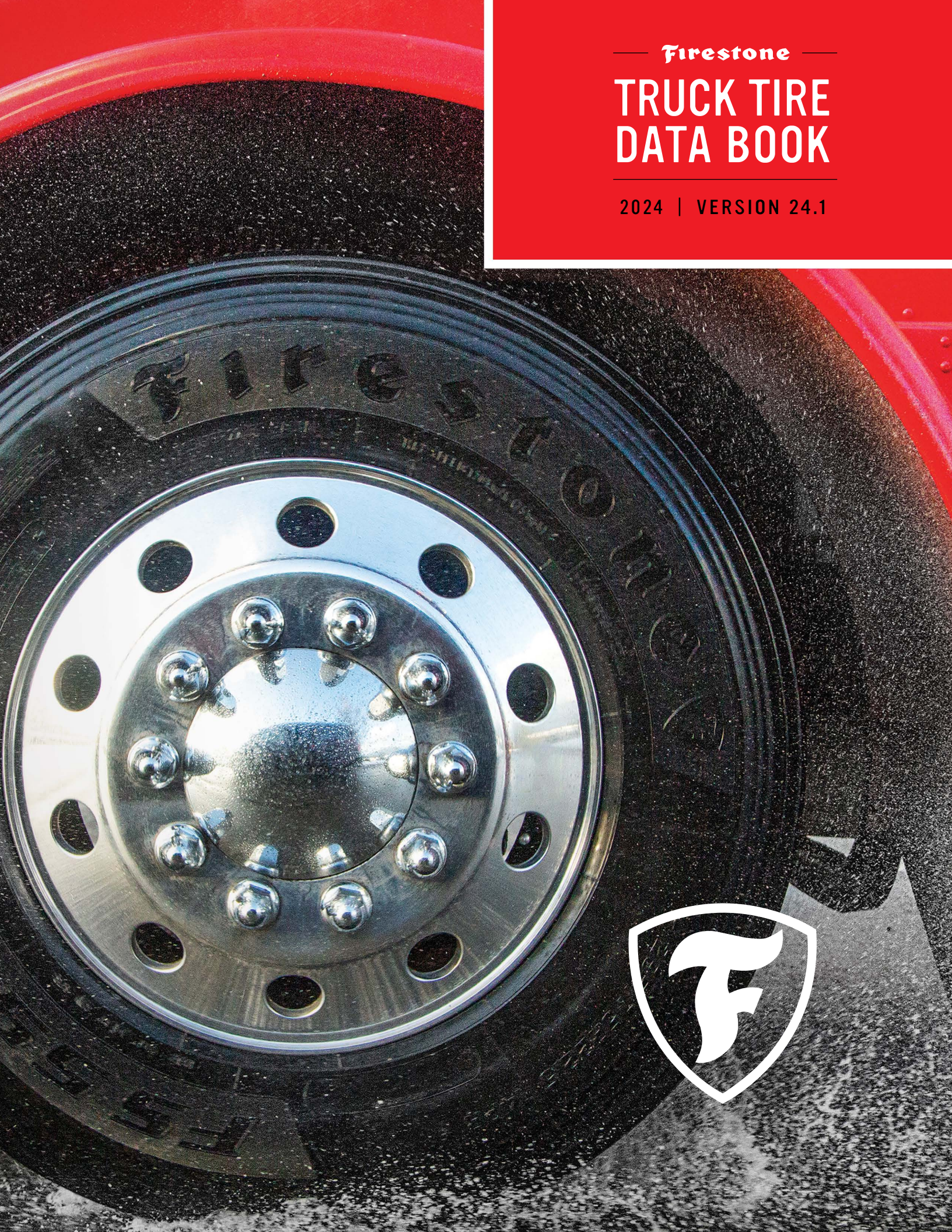



# Firestone

## Tire Data Book

### TABLE OF CONTENTS | Medium & Light Truck

<b>Recommended Medium Truck Tire Application .....</b>	<b>4</b>
<b>Medium Truck Tire Size &amp; Availability Chart.....</b>	<b>6 - 8</b>
<b>Medium Truck Tires .....</b>	<b>10 - 31</b>
<i>Medium Truck Tire – Discontinued Products .....</i>	<i>32 - 33</i>
<b>Light Truck Tire Size &amp; Availability Chart .....</b>	<b>36</b>
<b>Commercial Light Truck Tires .....</b>	<b>37 - 38</b>
<i>Commercial Light Truck Tire – Discontinued Products .....</i>	<i>39 - 40</i>
<b>General Technical Information .....</b>	<b>41 - 72</b>
<b>Load &amp; Inflation Tables .....</b>	<b>73 - 79</b>
<b>Technical Bulletins .....</b>	<b>81 - 97</b>
<b>Truck Tire Comparison Guide.....</b>	<b>98 - 101</b>

# Recommended Medium Truck Tire Application

CHOOSE THE FIRESTONE THAT'S BEST FOR YOU

■ Recommended ● Suitable

	SERVICE	PRODUCT	PAGE	STEER AXLE	DRIVE AXLE		TRAILER AXLE		
					SINGLE	TANDEM	TANDEM	SPREAD	
FIRESTONE	Long Haul Regional Haul	FS591	9	■	●	●	●		
		FD692	10		■	■			
		FD694	11		■	■			
		FT492	12				■	●	
	Long Haul Motor Coach	FS400	13	■	●	●	●		
		FD600	14		■	■			
	Regional Haul Urban	FS561A	15	■	●	●	●		
		FS561	16	■	●	●	●		
		Transforce AT <sup>2</sup> Commercial	17	■	■	■	■		
		FD711	18		■	■			
	Waste Severe Service	FS860	19	■	●	●	●		
	On/Off Highway	FS821	20	■	■	■	●		
		T819	21	●	●	●	■		
		T831	22		■	■			
		FS818	23	■	■	■	■		
	Severe On/Off Highway	FD835	24		■	■			
	FIRESTONE CLASSICS	Long Haul Regional Haul	FS509	26	■	●	●	●	
			FD609	27		■	■		
			FST409	28				■	●
		Regional Haul Urban	FS560 PLUS	29	■	●	●	●	●
FD663			30		■	■			



# Medium Truck Tires

## Medium Truck Tire Size & Availability Chart..... 6 - 8

### FIRESTONE

---

<b>FS591 Fuel-Efficient Steer Tire</b> .....	9
<b>FD692 Fuel-Efficient Drive Tire</b> .....	10
<b>FD694 Long- and Regional-Haul Drive Tire</b> .....	11
<b>FT492 Fuel-Efficient Trailer Tire</b> .....	12
<b>FS400 All-Position Tire</b> .....	13
<b>FD600 Drive Tire</b> .....	14
<b>FS561A Steer Tire</b> .....	15
<b>FS561 All-Position Tire</b> .....	16
<b>Transforce AT<sup>2</sup> Commercial All-Position Tire</b> .....	17
<b>FD711 Drive Tire</b> .....	18
<b>FS860 All-Position Tire</b> .....	19
<b>FS821 On/Off-Highway All-Position Tire</b> .....	20
<b>T819 On/Off-Highway All-Position Tire</b> .....	21
<b>T831 On/Off-Highway Drive Tire</b> .....	22
<b>FS818 On/Off-Highway All-Position Wide Base Tire</b> .....	23
<b>FD835 On/Off-Highway Drive Tire</b> .....	24

### FIRESTONE CLASSICS

---

<b>FS509 Fuel-Efficient Steer Tire</b> .....	26
<b>FD609 Drive Tire</b> .....	27
<b>FT409 Fuel-Efficient Trailer Tire</b> .....	28
<b>FS560 PLUS Steer Tire</b> .....	29
<b>FD663 Drive Tire</b> .....	30

<i>Medium Truck Tire – Discontinued Products</i> .....	32 - 33
--	---------

# Medium Truck Tire Size & Availability Charts

LOAD RANGE & TREAD DEPTHS (IN 32NDS) INDICATE AVAILABILITY

FIRESTONE	FS591	FD692	FD694	FT492	FS400	FD600	FS561A	FS561	Transforce AT <sup>2</sup> Commercial
SmartWay <sup>®</sup> Verified & CARB Compliant	■	■		■			■		
Meets 3 Peak Mountain Snow Flake Criteria		■							■
PAGE	9	10	11	12	13	14	15	16	17
REPLACES GOODYEAR	Marathon LHS	Marathon LHD	Marathon RSD	Marathon LHT	Marathon LHS II HL	Endurance TSD	Marathon RSA Marathon RSS	G647 RSS	G622 RSD
REPLACES CONTINENTAL	EcoPlus HS3+ EcoPlus HS3	HDL2	HDL2 DL HDL2 DL+	EcoPlus HT3	Coach HA3	HDR2	HSR2 HSR3	HSR+	HSR+ HDR+
REPLACES YOKOHAMA	101ZL	709ZL	TY517mc2 TY527	109L			108R 104ZR	104ZR 124R	115R 714R, 720R
REPLACES HANKOOK	AL21 AL11	DL12 DL11	DL21, DL12	TL21			AH24 AH37	AH35	DH07 DH35
SIZE	LOAD RANGE - TREAD DEPTH								
9R22.5							F-19		
10R22.5							G-20		
11R22.5	G/H-18	G-26	H-30	G-11			G/H-21		
11R24.5	G/H-18	G-26	H-30	G-11			G/H-21		
12R22.5							H-21		
12R24.5									
215/75R17.5								H-15	
225/70R19.5								F/G-16	F/G-19
245/70R19.5								F/G-18	G/H-18
255/70R22.5				H-11					
275/70R22.5							J-21		
295/75R22.5	G/H-18	G-26	H-30	G-11			G-21		
315/80R22.5					L-18	J-27			
385/65R22.5									
425/65R22.5									
445/65R22.5									
285/75R24.5	G-18	G-26	H-30	G-11			G-21		

# Medium Truck Tire Size & Availability Charts

LOAD RANGE & TREAD DEPTHS (IN 32NDS) INDICATE AVAILABILITY

<b>FIRESTONE</b>	<b>FD711</b>	<b>FS860</b>	<b>FS821</b>	<b>T819</b>	<b>T831</b>	<b>FS818</b>	<b>FD835</b>
<b>SmartWay® Verified &amp; CARB Compliant</b>							
<b>Meets 3 Peak Mountain Snow Flake Criteria</b>	■	■	■	■	■	■	■
<b>PAGE</b>	<b>18</b>	<b>19</b>	<b>20</b>	<b>21</b>	<b>22</b>	<b>23</b>	<b>24</b>
<b>REPLACES GOODYEAR</b>	Marathon RTD	G289 WHA	G751 MSA G731 MSA	Workhorse MSA	Workhorse MSD	G296 MSA	G741 MSD
<b>REPLACES CONTINENTAL</b>	HDR2 Hybrid HD3	HAU 3 WT	HSC3 HSC1	HSC3	HDC1 HT	HAC3	HDO
<b>REPLACES YOKOHAMA</b>	715R	506U MY627W	504C MY507	MY507	LY053	MY507A	
<b>REPLACES HANKOOK</b>	DH06	AM09	AM09	AM09	DM04	AM15	DM09
<b>SIZE</b>	<b>LOAD RANGE - TREAD DEPTH</b>						
9R22.5							
10R22.5							
11R22.5	H-26		H-24	H-20	H-31		
11R24.5	H-26		H-24	H-20	H-31		H-33
12R22.5				H-20	H-31		
12R24.5				H-20			
215/75R17.5							
225/70R19.5							
245/70R19.5							
255/70R22.5							
275/70R22.5							
295/75R22.5							
315/80R22.5		L-24	L-26	L-20			
385/65R22.5						J-23	
425/65R22.5						L-23	
445/65R22.5						L-24	
285/75R24.5							

# Medium Truck Tire Size & Availability Charts

LOAD RANGE & TREAD DEPTHS (IN 32NDS) INDICATE AVAILABILITY					CLASSIC
FIRESTONE CLASSICS	FS509	FD609	FT409	FS560 PLUS	FD663
SmartWay® Verified & CARB Compliant	■		■		
Meets 3 Peak Mountain Snow Flake Criteria		■			■
PAGE	26	27	28	29	30
REPLACES BF GOODRICH	HW Control S	DR444	HW CONTROL T	ROUTE CONTROL S	ROUTE CONTROL D
REPLACES TOYO	M137, M177	M647	M157	M170, M122	M610
REPLACES GENERAL	HS	HD	HT	RA	RD
SIZE	LOAD RANGE - TREAD DEPTH				
10R22.5					F-25
11R22.5	G-19	G-29	G-12	G/H-19	G/H-26
11R24.5	G-19	G-29		G/H-19	G/H-26
12R22.5					H-26
255/70R22.5				H-18	
295/75R22.5	G-19	G-29	G-12	G-19	G-26
285/75R24.5	G-19	G-29		G-19	G-26





## FS591

### Fuel-Efficient Steer Tire

- Combines low rolling resistance tread and energy-saving casing design to optimize fuel efficiency.
- ULTI-Rib™ and Defense Side Groove™ designs combat the initiation and spread of irregular wear.
- A wider and deeper tread and proprietary shoulder design results in greater removal mileage and irregular wear resistance.
- Innovative sidewall design reduces overall tire weight to improve fuel efficiency without sacrificing durability.

#### Recommended Application

An all-position tire recommended for steer applications in:  
**Long Haul Service / Regional Haul Service**

**Replaces:** Goodyear: Marathon LHS  
 Continental: EcoPlus HS3+, EcoPlus HS3  
 Yokohama: 101ZL  
 Hankook: AL21, AL11

EPA SmartWay® verified  
 and CARB compliant.

#### TECHNICAL DATA

Tire Size	Load Range	Material Number	Weight (lbs.)	Meas. Rim	Overall Diam.	Overall Width	Static Loaded Radius	Overall Width (Loaded)	Revs Per Mile	Tread Depth (32')	Max. Tire Load (Single)		Max. Tire Load (Dual)		Max. Speed (MPH)
											Kg/kPa	Lbs/PSI	Kg/kPa	Lbs/PSI	
<b>FS591</b>															
11R22.5	G	238-532	118	8.25	41.1	11.5	19.2	12.3	504	18	2800@720	6175@105	2650@720	5840@105	75
11R22.5	H	238-549	119	8.25	41.1	11.5	19.2	12.3	504	18	3000@830	6610@120	2725@830	6005@120	75
11R24.5	G	238-566	126	8.25	43.1	11.5	20.2	12.3	480	18	3000@720	6610@105	2725@720	6005@105	75
11R24.5	H	238-583	127	8.25	43.1	11.5	20.2	12.3	480	18	3250@830	7160@120	3000@830	6610@120	75
295/75R22.5	G	233-738	114	8.25	40.2	11.4	18.8	12.5	516	18	2800@760	6175@110	2575@760	5675@110	75
295/75R22.5	H	233-755	115	8.25	40.2	11.4	18.8	12.5	516	18	3250@830	7160@120	3000@830	6610@120	75
285/75R24.5	G	238-498	120	8.25	41.3	11.4	19.4	12.2	502	18	2800@760	6175@110	2575@760	5675@110	75

- All dimensions taken with tire on measuring rim.
- Loaded dimensions and RPM measured at maximum dual load.
- For load and inflation tables see pages 61 through 65.
- For minimum dual spacing and approved rim widths see page 44.
- For ply ratings see table on page 42.

Firestone tires and tubes are subject to an ongoing development program. Bridgestone Americas Tire Operations, LLC retains the right to amend specifications at any time without notice or obligations. Please refer to rim manufacturer's load and inflation limits. Never exceed rim manufacturer's limits without the consent of the component manufacturer.



## FD692

Fuel-Efficient Drive Tire

- SmartWay verified and CARB Compliant fuel efficient and aggressive tread design without compromising on all-weather dependability and traction
- 400% more biting edges than the previous generation FD691<sup>1</sup>, allowing for improved wet and snow traction.
- Confident control in rain and snow with increased shoulder slots help evacuate water
- Stone Rejector Platform helps to prevent trapped stones from pushing into the tread groove and piercing belt layer to increase retreadability of the casing
- Innovative low rolling resistance casing saves fuel throughout the life-cycle of the casing.

EPA SmartWay<sup>®</sup> verified and CARB compliant.



The Firestone FD692 meets 3 Peak Mountain Snow Flake (3PMSF) criteria for snow traction performance.

### Recommended Application

A drive tire recommended for tandem- and single-drive axle applications in:

**Long Haul Service / Regional Haul Service**

**Replaces:** Goodyear: Marathon LHD      Yokohama: 709ZL  
Hankook: DL12, DL11

### TECHNICAL DATA

Tire Size	Load Range	Material Number	Weight (lbs.)	Meas. Rim	Overall Diam.	Overall Width	Static Loaded Radius	Overall Width (Loaded)	Revs Per Mile	Tread Depth (32')	Max. Tire Load (Single)		Max. Tire Load (Dual)		Max. Speed (MPH)
											Kg/kPa	Lbs/PSI	Kg/kPa	Lbs/PSI	
<b>FD692</b>															
11R22.5	G	003-155	126	8.25	41.7	11.2	19.4	12.3	498	26	2800@720	6175@105	2650@720	5840@105	75
11R24.5	G	003-157	133	8.25	43.6	11.1	20.4	12.2	477	26	3000@720	6610@105	2725@720	6005@105	75
295/75R22.5	G	003-153	111	8.25	40.4	11.1	18.9	12.4	514	26	2800@760	6175@110	2575@760	5675@110	75
285/75R24.5	G	003-154	125	8.25	41.7	11.2	19.6	12.3	499	26	2800@760	6175@110	2575@760	5675@110	75

<sup>1</sup> Comparison based on Firestone FD692 tire vs. Firestone FD691 tire from internal testing. Results may vary.

- All dimensions taken with tire on measuring rim.
- Loaded dimensions and RPM measured at maximum dual load.
- For load and inflation tables see pages 61 through 65.
- For minimum dual spacing and approved rim widths see page 44.
- For ply ratings see table on page 42.

Firestone tires and tubes are subject to an ongoing development program. Bridgestone Americas Tire Operations, LLC retains the right to amend specifications at any time without notice or obligations. Please refer to rim manufacturer's load and inflation limits. Never exceed rim manufacturer's limits without the consent of the component manufacturer.



## FD694 Drive Tire

- Deep and High Rigidity Tread Pattern offers long, even wear by controlling movement of the ribs and blocks during rotation.
- Stabilizing Solid Shoulder Design distributes weight and torque to fight irregular wear and block squirm for even wear.
- Wide Shoulder and Center Grooves efficiently evacuates water to promote traction for a solid grip on the wet roads.
- Casing-saving Stone Rejector Platforms helps prevent trapped stones from pushing deeper into tread grooves and piercing belt layer, damaging and exposing belts to rust.
- Long-wearing Cap Compound is engineered for excellent mileage while the base compound shields the casing from damaging heat, enhancing retreadability.



The Firestone FD694 meets 3 Peak Mountain Snow Flake (3PMSF) criteria for snow traction performance.

### Recommended Application

A drive tire recommended for tandem- and single-drive axle applications in:

**Long Haul Service / Regional Haul Service**

**Replaces:** Goodyear: Marathon RSD    Yokohama: TY517mc2, TY527  
Continental: HDL2 DL, HDL2 DL+    Hankook: L21, DL12

### TECHNICAL DATA

Tire Size	Load Range	Material Number	Weight (lbs.)	Meas. Rim	Overall Diam.	Overall Width	Static Loaded Radius	Overall Width (Loaded)	Revs Per Mile	Tread Depth (32')	Max. Tire Load (Single)		Max. Tire Load (Dual)		Max. Speed (MPH)
											Kg/kPa	Lbs/PSI	Kg/kPa	Lbs/PSI	
<b>FD692</b>															
11R22.5	H	004-193	131	8.25	42.1	11.3	19.6	12.4	494	30	3000@830	6610@120	2725@830	6005@120	75
11R24.5	H	004-194	143	8.25	44.1	11.3	20.6	12.4	471	30	3250@830	7160@120	3000@830	6610@120	75
295/75R22.5	G	004-190	122	8.25	40.8	11.4	19.0	12.5	510	30	2800@760	6175@110	2575@760	5675@110	75
285/75R24.5	G	004-192	130	8.25	42.2	11.3	19.8	12.4	492	30	2800@760	6175@110	2575@760	5675@110	75

- All dimensions taken with tire on measuring rim.
- Loaded dimensions and RPM measured at maximum dual load.
- For load and inflation tables see pages 61 through 65.
- For minimum dual spacing and approved rim widths see page 44.
- For ply ratings see table on page 42.

Firestone tires and tubes are subject to an ongoing development program. Bridgestone Americas Tire Operations, LLC retains the right to amend specifications at any time without notice or obligations. Please refer to rim manufacturer's load and inflation limits. Never exceed rim manufacturer's limits without the consent of the component manufacturer.



## FT492 Fuel-Efficient Trailer Tire

- Sidewall protector ribs resist curb damage and abrasion.
- Defense Groove™ structure helps create uniform pressure at the shoulder to minimize edge wear for long tread life.
- High rigidity tread pattern offers long, even wear and reduced rolling resistance by controlling movement of the ribs and blocks during rotation.
- Intellishape sidewall design reduces overall tire weight to improve fuel efficiency without sacrificing durability.

### Recommended Application

A trailer tire suitable for single- and tandem-axle trailer and dolly applications in:

**Long Haul Service / Regional Haul Service**

**Replaces:** Goodyear: Marathon LHT  
Continental: EcoPlus HT3  
Yokohama: 109L  
Hankook: TL21

EPA SmartWay® verified  
and CARB compliant.

### TECHNICAL DATA

Tire Size	Load Range	Material Number	Weight (lbs.)	Meas. Rim	Overall Diam.	Overall Width	Static Loaded Radius	Overall Width (Loaded)	Revs Per Mile	Tread Depth (32')	Max. Tire Load (Single)		Max. Tire Load (Dual)		Max. Speed (MPH)
											Kg/kPa	Lbs/PSI	Kg/kPa	Lbs/PSI	
<b>FT492</b>															
11R22.5	G	004-230	103	8.25	40.6	11.3	19.0	12.5	512	11	2800@720	6175@105	2650@720	5840@105	75
11R24.5	G	004-231	109	8.25	42.8	11.4	20.0	12.5	486	11	3000@720	6610@105	2725@720	6005@105	75
255/70R22.5	H	004-232	84	8.25	36.3	10.4	17.1	11.5	572	11	2500@830	5510@120	2300@830	5070@120	75
295/75R22.5	G	004-228	94	8.25	39.5	11.5	18.5	12.7	525	11	2800@760	6175@110	2650@720	5675@110	75
285/75R24.5	G	004-229	103	8.25	40.8	11.3	19.2	12.4	509	11	2800@760	6175@110	2575@760	5675@110	75

- All dimensions taken with tire on measuring rim.
- Loaded dimensions and RPM measured at maximum dual load.
- For load and inflation tables see pages 61 through 65.
- For minimum dual spacing and approved rim widths see page 44.
- For ply ratings see table on page 42.

Firestone tires and tubes are subject to an ongoing development program. Bridgestone Americas Tire Operations, LLC retains the right to amend specifications at any time without notice or obligations. Please refer to rim manufacturer's load and inflation limits. Never exceed rim manufacturer's limits without the consent of the component manufacturer.



## FS400 All-Position Tire

- Built for heavy loads in on-highway and inter-city bus service.
- Deep tread, flow-through grooves and cross-rib siping provide long life and high traction in all weather conditions.
- Shoulder wear protector ribs combat initiation and spread of irregular wear.
- Stone-rejector platforms help prevent the retention of casing-damaging stones for enhanced retreadability.

### Recommended Application

An all-position tire recommended for:  
**Long Haul Service / Motor Coach**

*Replaces:* Goodyear: Marathon LHS II HL  
Continental: Coach HA3

### TECHNICAL DATA

Tire Size	Load Range	Material Number	Weight (lbs.)	Meas. Rim	Overall Diam.	Overall Width	Static Loaded Radius	Overall Width (Loaded)	Revs Per Mile	Tread Depth (32')	Max. Tire Load (Single)		Max. Tire Load (Dual)		Max. Speed (MPH)
											Kg/kPa	Lbs/PSI	Kg/kPa	Lbs/PSI	
<b>FS400</b>															
315/80R22.5 †	L	004-168	146	9.00	42.4	12.4	19.7	13.9	490	18	4250@900	9370@130	4000@900	8820@130	75

† Requires the use of a 9.00-inch rim to carry over 8,000 lbs.

- All dimensions taken with tire on measuring rim.
- Loaded dimensions and RPM measured at maximum dual load.
- For load and inflation tables see pages 61 through 65.
- For minimum dual spacing and approved rim widths see page 44.
- For ply ratings see table on page 42.

Firestone tires and tubes are subject to an ongoing development program. Bridgestone Americas Tire Operations, LLC retains the right to amend specifications at any time without notice or obligations. Please refer to rim manufacturer's load and inflation limits. Never exceed rim manufacturer's limits without the consent of the component manufacturer.



## FD600 Drive Tire

- Open-shoulder lug pattern and tread design help to provide aggressive traction on wet and dry conditions.
- Individual traction blocks and multiple block edges offer improved pulling power.
- Flow-through design allows for water evacuation to help enhance road grip.
- Cap/base compounding combines a slow-wearing cap compound with a cool-running base that shields the casing from damaging heat to enhance retreadability.

### Recommended Application

An all-position tire recommended for:  
**Long Haul Service / Motor Coach**

**Replaces:** Goodyear: Endurance TSD  
Continental: HDR2

### TECHNICAL DATA

Tire Size	Load Range	Material Number	Weight (lbs.)	Meas. Rim	Overall Diam.	Overall Width	Static Loaded Radius	Overall Width (Loaded)	Revs Per Mile	Tread Depth (32')	Max. Tire Load (Single)		Max. Tire Load (Dual)		Max. Speed (MPH)
											Kg/kPa	Lbs/PSI	Kg/kPa	Lbs/PSI	
<b>FD600</b>															
315/80R22.5 †	J	219-696	165	9.00	42.9	12.4	19.9	13.6	484	27	3750@830	8270@120	3450@830	7610@120	75

† Requires the use of a 9.00-inch rim to carry over 8,000 lbs.

- All dimensions taken with tire on measuring rim.
- Loaded dimensions and RPM measured at maximum dual load.
- For load and inflation tables see pages 61 through 65.
- For minimum dual spacing and approved rim widths see page 44.
- For ply ratings see table on page 42.

Firestone tires and tubes are subject to an ongoing development program. Bridgestone Americas Tire Operations, LLC retains the right to amend specifications at any time without notice or obligations. Please refer to rim manufacturer's load and inflation limits. Never exceed rim manufacturer's limits without the consent of the component manufacturer.



## FS561A Steer Tire

- Tread cap compound and solid shoulder ribs enhance resistance to maneuvering scrub, leading to increased tread life.
- Stone rejectors in center grooves help provide resistance to stone drilling and protect belts for enhanced casing durability.
- Stress relief sipes fight irregular wear by absorbing rib edge stresses in the footprint for long, even wear.
- Sidewall protector ribs help protect the casing from cuts, snags and abrasions due to curbing and impacts.
- Innovative sidewall design reduces overall weight to improve fuel efficiency without sacrificing durability.

### Recommended Application

An all-position tire recommended for steer application in:  
**Regional Haul Service / Urban Service**

*NOT recommended for spread axle, heavy haul, high-scrub applications.*

**Replaces:** Goodyear: Marathon RSA, Marathon RSS  
Continental: HSR2, HSR3  
Yokohama: 108R, 104ZR  
Hankook: AH24, AH37

EPA SmartWay® verified  
and CARB compliant.

### TECHNICAL DATA

Tire Size	Load Range	Material Number	Weight (lbs.)	Meas. Rim	Overall Diam.	Overall Width	Static Loaded Radius	Overall Width (Loaded)	Revs Per Mile	Tread Depth (32")	Max. Tire Load (Single)		Max. Tire Load (Dual)		Max. Speed (MPH)
											Kg/kPa	Lbs/PSI	Kg/kPa	Lbs/PSI	
<b>FS561A</b>															
9R22.5	F	012-718	90	6.75	38.4	9.0	9.9	18.0	541	19	2060@720	4540@105	1950@720	4300@105	75
10R22.5	G	012-714	97	7.50	40.2	9.9	10.9	18.8	517	20	2575@790	5675@115	2430@790	5355@115	75
11R22.5	G	012-709	123	8.25	41.5	10.9	12.0	19.3	501	21	2800@720	6175@105	2650@720	5840@105	75
11R22.5	H	012-710	123	8.25	41.5	10.9	12.0	19.3	501	21	3000@830	6610@120	2725@830	6005@120	75
11R24.5	G	012-711	134	8.25	43.6	10.9	12.0	20.4	477	21	3000@720	6610@105	2725@720	6005@105	75
11R24.5	H	012-712	134	8.25	43.6	10.9	12.0	20.4	477	21	3250@830	7160@120	3000@830	6610@120	75
12R22.5	H	012-715	140	9.00	42.7	11.7	12.9	19.9	486	21	3350@830	7390@120	3075@830	6780@120	75
275/70R22.5	J	012-716	99	8.25	38.1	10.9	12.0	17.9	545	21	3150@900	6940@130	2900@900	6395@130	75
295/75R22.5	G	012-707	116	8.25	40.4	11.0	12.1	18.9	514	21	2800@760	6175@110	2575@760	5675@110	75
285/75R24.5	G	012-708	121	8.25	41.5	10.8	11.9	19.5	501	21	2800@760	6175@110	2575@760	5675@110	75

Firestone tires and tubes are subject to an ongoing development program. Bridgestone Americas Tire Operations, LLC retains the right to amend specifications at any time without notice or obligations. Please refer to rim manufacturer's load and inflation limits. Never exceed rim manufacturer's limits without the consent of the component manufacturer.



## FS561 All-Position Tire

- Tread cap compound and solid shoulder ribs enhance resistance to maneuvering scrub, leading to increased tread life.
- Stone rejectors in center grooves help provide resistance to stone drilling and protect belts for enhanced casing durability.
- Stress relief sipes fight irregular wear by absorbing rib edge stresses in the footprint for long, even wear.
- Sidewall protector ribs help protect the casing from cuts, snags and abrasions due to curbing and impacts.
- Innovative sidewall design reduces overall weight to improve fuel efficiency without sacrificing durability.

### Recommended Application

An all-position tire recommended for steer application in:  
**Regional Haul Service / Urban Service**

*NOT recommended for spread axle, heavy haul, high-scrub applications.*

**Replaces:** Goodyear: G647 RSS  
Continental: HSR+  
Yokohama: 104ZR, 124R  
Hankook: AH35

### TECHNICAL DATA

Tire Size	Load Range	Material Number	Weight (lbs.)	Meas. Rim	Overall Diam.	Overall Width	Static Loaded Radius	Overall Width (Loaded)	Revs Per Mile	Tread Depth (32')	Max. Tire Load (Single)		Max. Tire Load (Dual)		Max. Speed (MPH)
											Kg/kPa	Lbs/PSI	Kg/kPa	Lbs/PSI	
<b>FS561</b>															
215/75R17.5	H	248-511	66	6.00	30.7	8.8	14.4	9.1	677	15	2180@830	4805@120	2060@830	4540@120	68
225/70R19.5	F	248-409	64	6.00	32.2	8.7	9.5	15.0	644	16	1650@660	3640@95	1550@660	3415@95	75
225/70R19.5	G	248-426	64	6.00	32.2	8.7	9.5	15.0	644	16	1800@760	3970@110	1700@760	3750@110	75
245/70R19.5	F	248-443	82	6.75	33.3	9.3	15.5	10.3	623	18	1850@660	4080@95	1750@660	3860@95	75
245/70R19.5	G	248-477	82	6.75	33.3	9.3	15.5	10.3	623	18	2060@760	4545@110	1985@760	4375@110	75

Firestone tires and tubes are subject to an ongoing development program. Bridgestone Americas Tire Operations, LLC retains the right to amend specifications at any time without notice or obligations. Please refer to rim manufacturer's load and inflation limits. Never exceed rim manufacturer's limits without the consent of the component manufacturer.





## Transforce AT<sup>2</sup> Commercial

All-Position Tire

- Optimized tread design maximizes the balance of wear and traction performance in all weather conditions.
- Pattern features combined with an innovative tread-to-road contact footprint to help retain performance over the course of the life of the tire.
- Sidewall protector ribs preserve casing durability by fighting curbing damage with thick ribs on both sidewalls.
- Cap/base compounding combines a slow-wearing cap compound with a cool-running base that shields the casing from damaging heat to enhance retreadability.

### Recommended Application

An All-Position tire recommended for class 4-5 commercial vehicle applications in:

**Regional Haul Service / Urban Service**

**Replaces:** Goodyear: G622 RSD

Continental: HSR+, HDR+

Yokohama: 115R, 714R, 720R

Hankook: DH07, DH35



• The Firestone Transforce AT<sup>2</sup> Commercial meets 3 Peak Mountain Snow Flake (3PMSF) criteria for snow traction performance.

### TECHNICAL DATA

Tire Size	Load Range	Material Number	Weight (lbs.)	Meas. Rim	Overall Diam.	Overall Width	Static Loaded Radius	Overall Width (Loaded)	Revs Per Mile	Tread Depth (32')	Max. Tire Load (Single)		Max. Tire Load (Dual)		Max. Speed (MPH)
											Kg/kPa	Lbs/PSI	Kg/kPa	Lbs/PSI	
<b>Transforce AT<sup>2</sup> Commercial</b>															
225/70R19.5	F	004-195	66	6.00	32.4	8.7	15.1	9.5	640	19	1650@660	3640@95	1550@660	3415@95	75
225/70R19.5	G	004-196	66	6.00	32.4	8.7	15.1	9.5	640	19	1800@760	3970@110	1700@760	3750@110	87
245/70R19.5	G	004-197	82	6.75	33.4	9.3	10.3	15.5	621	18	2060@760	4540@110	1950@760	4300@110	75
245/70R19.5	H	013-842	82	6.75	33.4	9.3	10.3	15.5	621	18	2240@830	4940@120	2120@830	4675@120	75

- All dimensions taken with tire on measuring rim.
- Loaded dimensions and RPM measured at maximum dual load.
- For load and inflation tables see pages 61 through 65.
- For minimum dual spacing and approved rim widths see page 44.
- For ply ratings see table on page 42.

Firestone tires and tubes are subject to an ongoing development program. Bridgestone Americas Tire Operations, LLC retains the right to amend specifications at any time without notice or obligations. Please refer to rim manufacturer's load and inflation limits. Never exceed rim manufacturer's limits without the consent of the component manufacturer.



## FD711 Drive Tire

- Open shoulder design promotes exceptional traction.
- Aggressive blocks with multiple gripping edges provide biting edges for exceptional grip.
- Four belt construction helps casing durability and enhances retreadability by combating casing penetration.
- Cap/base compounding combines a slow-wearing cap compound with a cool-running base that shields the casing from damaging heat to enhance retreadability.

### Recommended Application

A drive tire recommended for high traction and high-scrub drive axle applications in:

**Regional Haul Service / Urban Service**

**Replaces:** Goodyear: Marathon RTD  
Continental: HDR2, Hybrid HD3  
Yokohama: 715R  
Hankook: DH06



The Firestone FD711 meets 3 Peak Mountain Snow Flake (3PMSF) criteria for snow traction performance.

### TECHNICAL DATA

Tire Size	Load Range	Material Number	Weight (lbs.)	Meas. Rim	Overall Diam.	Overall Width	Static Loaded Radius	Overall Width (Loaded)	Revs Per Mile	Tread Depth (32')	Max. Tire Load (Single)		Max. Tire Load (Dual)		Max. Speed (MPH)
											Kg/kPa	Lbs/PSI	Kg/kPa	Lbs/PSI	
<b>FD711</b>															
11R22.5	H	011-473	125	8.25	41.9	10.7	19.6	11.8	496	26	3000@830	6610@120	2725@830	6005@120	75
11R24.5	H	011-474	133	8.25	43.9	10.7	20.6	11.8	473	26	3250@830	7160@120	3000@830	6610@120	75

- All dimensions taken with tire on measuring rim.
- Loaded dimensions and RPM measured at maximum dual load.
- For load and inflation tables see pages 61 through 65.
- For minimum dual spacing and approved rim widths see page 44.
- For ply ratings see table on page 42.

Firestone tires and tubes are subject to an ongoing development program. Bridgestone Americas Tire Operations, LLC retains the right to amend specifications at any time without notice or obligations. Please refer to rim manufacturer's load and inflation limits. Never exceed rim manufacturer's limits without the consent of the component manufacturer.



## FS860 All-Position Tire

- Engineered specifically for refuse, high-scrub, short-haul applications.
- Stone rejector platforms prevent trapped stones from pushing deeper into tread grooves and piercing belt layer, damaging belts and exposing them to rust.
- Solid shoulder design distributes weight and torque to fight irregular wear and block squirm for outstanding, even wear.
- Angled grooves provide biting edges that help promote wet traction.
- Sidewall protector ribs designed to fight curbing and abrasion damage, to help enhance casing durability.

### Recommended Application

An all-position tire recommended for:  
**Waste / Severe Service**

**Replaces:** Goodyear: G289 WHA  
Continental: HAU 3 WT  
Yokohama: 506U, MY627W  
Hankook: AM09



.....  
The Firestone FS860 meets 3 Peak Mountain Snow Flake (3PMSF) criteria for snow traction performance.  
.....

### TECHNICAL DATA

Tire Size	Load Range	Material Number	Weight (lbs.)	Meas. Rim	Overall Diam.	Overall Width	Static Loaded Radius	Overall Width (Loaded)	Revs Per Mile	Tread Depth (32')	Max. Tire Load (Single)		Max. Tire Load (Dual)		Max. Speed (MPH)
											Kg/kPa	Lbs/PSI	Kg/kPa	Lbs/PSI	
<b>FS860</b>															
315/80R22.5 †	L	244-465	161	9.00	42.8	12.6	19.9	13.9	485	24	4540@900	10000@130	4120@900	9090@130	68

† Requires the use of a 9.00-inch rim to carry over 8,000 lbs.

- All dimensions taken with tire on measuring rim.
- Loaded dimensions and RPM measured at maximum dual load.
- For load and inflation tables see pages 61 through 65.
- For minimum dual spacing and approved rim widths see page 44.
- For ply ratings see table on page 42.

Firestone tires and tubes are subject to an ongoing development program. Bridgestone Americas Tire Operations, LLC retains the right to amend specifications at any time without notice or obligations. Please refer to rim manufacturer's load and inflation limits. Never exceed rim manufacturer's limits without the consent of the component manufacturer.



## FS821

### On/Off-Highway All-Position Tire

- 15% longer mileage and 9 % better wet traction than the previous generation FS820.<sup>1</sup>
- Improved footprint area maintains better contact area throughout the life of the tread for smooth even wear.
- Improved groove angles to prevent stone retention and maintain casing retreadability.
- Stone rejector platforms prevents stones from becoming trapped in the tread to protect the casing from potential damage.
- FS821 shows 80% less stone holding than the previous generation FS820.<sup>1</sup>
- 50% more biting edges than previous generation FS820<sup>1</sup>, allowing for improved wet and snow traction.
- All-steel casing construction and cap/base compounding helps resist cuts and improves durability and retreadability.



.....  
 ..... The Firestone FS821 meets 3 Peak  
 ..... Mountain Snow Flake (3PMSF) criteria  
 ..... for snow traction performance.

#### Recommended Application

An all-position tire recommended for:  
**On/Off Highway Service**

**Replaces:** Goodyear: G751 MSA  
 Continental: HSC3, HSC1

Yokohama: 504C, MY507  
 Hankook: AM09

#### TECHNICAL DATA

Tire Size	Load Range	Material Number	Weight (lbs.)	Meas. Rim	Overall Diam.	Overall Width	Static Loaded Radius	Overall Width (Loaded)	Revs Per Mile	Tread Depth (32')	Max. Tire Load (Single)		Max. Tire Load (Dual)		Max. Speed (MPH)
											Kg/kPa	Lbs/PSI	Kg/kPa	Lbs/PSI	
<b>FS821</b>															
11R22.5	H	003-159	127	8.25	42.0	11.0	19.5	12.1	495	24	3000@830	6610@120	2725@830	6005@120	68
11R24.5	H	003-161	142	8.25	44.0	10.9	20.5	12.0	472	24	3250@830	7160@120	3000@830	6610@120	68
315/80R22.5 †	L	003-164	152	9.00	42.9	12.7	19.9	13.9	484	26	4125@900	9090@130	3750@900	8270@130	68

† Requires the use of a 9.00-inch rim to carry over 8,000 lbs.

<sup>1</sup> Comparison based on Firestone FS821 tire vs. Firestone FS820 tire from internal testing. Results may vary.

- All dimensions taken with tire on measuring rim.
- Loaded dimensions and RPM measured at maximum dual load.
- For load and inflation tables see pages 61 through 65.
- For minimum dual spacing and approved rim widths see page 44.
- For ply ratings see table on page 42.

Firestone tires and tubes are subject to an ongoing development program. Bridgestone Americas Tire Operations, LLC retains the right to amend specifications at any time without notice or obligations. Please refer to rim manufacturer's load and inflation limits. Never exceed rim manufacturer's limits without the consent of the component manufacturer.



## T819

*On/Off-Highway  
All-Position Tire*

- Rugged four-rib design with special groove shape to combat stone retention for long mileage and retreadability.
- Tread compounded and constructed to resist cuts and impacts in on/off-highway service.
- Tread designed with variable-pitch noise treatment to help deliver a quiet ride, and help to improve durability and traction.
- Four steel belts and an all-steel casing ply for durability and improved retread performance.

### Recommended Application

An all-position tire recommended for:  
**On/Off Highway Service**

**Replaces:** Goodyear: Workhorse MSA  
Continental: HSC3  
Yokohama: MY507  
Hankook: AM09



The Firestone T819 meets 3 Peak Mountain Snow Flake (3PMSF) criteria for snow traction performance.

### TECHNICAL DATA

Tire Size	Load Range	Article Number	Weight (lbs.)	Meas. Rim	Overall Diam.	Overall Width	Static Loaded Radius	Overall Width (Loaded)	Revs Per Mile	Tread Depth (32')	Max. Tire Load (Single)		Max. Tire Load (Dual)		Max. Speed (MPH)
											Kg/kPa	Lbs/PSI	Kg/kPa	Lbs/PSI	
<b>T819</b>															
11R22.5	H	294-535	125	8.25	41.6	10.7	19.4	11.7	499	20	3000@830	6610@120	2725@830	6005@120	65
11R24.5	H	294-543	131	8.25	43.6	10.7	20.4	11.7	476	20	3250@830	7160@120	3000@830	6610@120	65
12R22.5	H	157-341	139	9.00	42.7	11.6	19.8	12.6	487	20	3350@830	7390@120	3075@830	6780@120	65
12R24.5	H	157-368	148	9.00	44.7	11.3	20.8	12.3	465	20	3550@830	7830@120	3250@830	7160@120	65
315/80R22.5 †	L	157-147	148	9.00	42.7	12.1	19.7	13.1	487	20	4125@900	9090@130	3750@900	8270@130	55

† Requires the use of a 9.00-inch rim to carry over 8,000 lbs.

- All dimensions taken with tire on measuring rim.
- Loaded dimensions and RPM measured at maximum dual load.
- For load and inflation tables see pages 61 through 65.
- For minimum dual spacing and approved rim widths see page 44.
- For ply ratings see table on page 42.

Firestone tires and tubes are subject to an ongoing development program. Bridgestone Americas Tire Operations, LLC retains the right to amend specifications at any time without notice or obligations. Please refer to rim manufacturer's load and inflation limits. Never exceed rim manufacturer's limits without the consent of the component manufacturer.



## T831

*On/Off-Highway  
Drive Tire*

- Aggressive lug pattern for a strong grip.
- Extra-deep tread for long original mileage.
- Specially formulated on/off-highway tread compound helps resist chips, cuts, and tears.
- Stress-relief body ply contour helps to provides durability and retreadability.

### Recommended Application

A drive tire recommended for:  
**Severe On/Off Highway Service**

**Replaces:** Goodyear: Workhorse MSD  
Continental: HDC1 HT  
Yokohama: LY053  
Hankook: DM04



.....  
The Firestone T831 meets 3 Peak Mountain Snow Flake (3PMSF) criteria for snow traction performance.  
.....

### TECHNICAL DATA

Tire Size	Load Range	Material Number	Weight (lbs.)	Meas. Rim	Overall Diam.	Overall Width	Static Loaded Radius	Overall Width (Loaded)	Revs Per Mile	Tread Depth (32')	Max. Tire Load (Single)		Max. Tire Load (Dual)		Max. Speed (MPH)
											Kg/kPa	Lbs/PSI	Kg/kPa	Lbs/PSI	
<b>T831</b>															
11R22.5	H	281-557	134	8.25	42.4	10.7	19.7	11.8	490	31	3000@830	6610@120	2725@830	6005@120	55
11R24.5	H	281-565	142	8.25	44.5	10.7	20.8	11.8	467	31	3250@830	7160@120	3000@830	6610@120	55
12R22.5	H	281-581	150	9.00	43.6	11.4	20.2	12.7	476	31	3350@830	7390@120	3075@830	6780@120	55

- All dimensions taken with tire on measuring rim.
- Loaded dimensions and RPM measured at maximum dual load.
- For load and inflation tables see pages 61 through 65.
- For minimum dual spacing and approved rim widths see page 44.
- For ply ratings see table on page 42.

Firestone tires and tubes are subject to an ongoing development program. Bridgestone Americas Tire Operations, LLC retains the right to amend specifications at any time without notice or obligations. Please refer to rim manufacturer's load and inflation limits. Never exceed rim manufacturer's limits without the consent of the component manufacturer.



# FS818

*On/Off-Highway  
All-Position Wide Base Tire*

- Wide base design for higher payload and flotation so tires maintain grip and traction without digging into the ground.
- Four full-width steel belts combat tread squirm and enhance retreadability.
- Self-cleaning tread pattern provides high traction with stone rejector platforms in every groove for excellent durability.

### Recommended Application

An all-position wide base tire recommended for:  
**On/Off Highway Service**

**Replaces:** Goodyear: G296 MSA  
Continental: HAC3  
Yokohama: MY507A  
Hankook: AM15



The Firestone FS818 meets 3 Peak Mountain Snow Flake (3PMSF) criteria for snow traction performance.

### TECHNICAL DATA

Tire Size	Load Range	Material Number	Weight (lbs.)	Meas. Rim	Overall Diam.	Overall Width	Static Loaded Radius	Overall Width (Loaded)	Revs Per Mile	Tread Depth (32')	Max. Tire Load (Single)		Max. Tire Load (Dual)		Max. Speed (MPH)
											Kg/kPa	Lbs/PSI	Kg/kPa	Lbs/PSI	
<b>FS818</b>															
385/65R22.5	J	247-780	172	12.25	42.9	15.1	19.8	16.6	484	23	9370@120	4250@830	-	-	68
425/65R22.5	L	241-235	194	12.25	44.8	16.1	20.6	17.7	463	23	11400@120	5150@830	-	-	68
445/65R22.5	L	247-797	214	13.00	46.0	17.5	21.1	19.2	452	24	12300@120	5600@830	-	-	68

- All dimensions taken with tire on measuring rim.
- Loaded dimensions and RPM measured at maximum dual load.
- For load and inflation tables see pages 61 through 65.
- For minimum dual spacing and approved rim widths see page 44.
- For ply ratings see table on page 42.

Firestone tires and tubes are subject to an ongoing development program. Bridgestone Americas Tire Operations, LLC retains the right to amend specifications at any time without notice or obligations. Please refer to rim manufacturer's load and inflation limits. Never exceed rim manufacturer's limits without the consent of the component manufacturer.



## FD835

*On/Off-Highway  
Drive Tire*

- Extra-deep tread helps to extend original casing life.
- Block design with angled siping helps to provide aggressive traction for both on and off highway use.
- Tough tread compound helps resist cuts, chips, chunks, and tears.
- Split-belt construction provides extra flexibility and durability in severe-service applications.

### Recommended Application

A drive tire recommended for:  
**Severe On/Off Highway Service**

**Replaces:** Goodyear: G741 MSD  
Continental: HDO  
Hankook: DM09



The Firestone FD835 meets 3 Peak Mountain Snow Flake (3PMSF) criteria for snow traction performance.

### TECHNICAL DATA

Tire Size	Load Range	Material Number	Weight (lbs.)	Meas. Rim	Overall Diam.	Overall Width	Static Loaded Radius	Overall Width (Loaded)	Revs Per Mile	Tread Depth (32')	Max. Tire Load (Single)		Max. Tire Load (Dual)		Max. Speed (MPH)
											Kg/kPa	Lbs/PSI	Kg/kPa	Lbs/PSI	
<b>FD835</b>															
11R24.5	H	208-945	144	8.25	44.7	10.8	20.8	11.9	465	33	3250@830	7160@120	3000@830	6610@120	65

- All dimensions taken with tire on measuring rim.
- Loaded dimensions and RPM measured at maximum dual load.
- For load and inflation tables see pages 61 through 65.
- For minimum dual spacing and approved rim widths see page 44.
- For ply ratings see table on page 42.

Firestone tires and tubes are subject to an ongoing development program. Bridgestone Americas Tire Operations, LLC retains the right to amend specifications at any time without notice or obligations. Please refer to rim manufacturer's load and inflation limits. Never exceed rim manufacturer's limits without the consent of the component manufacturer.





CLASSIC



# FS509

Steer Tire



Standard Profile

Low-Profile

- Shoulder-wear protector and stress relief sipes help minimize irregular wear for long tread life.
- Optimized belt package achieves durability and retreadability while delivering reduced weight for improved rolling resistance and payload.
- Tough sidewall protection with thick ribs on both sidewalls to fight curbing damage to protect the casing.
- IntelliShape™ sidewall low bead filler volume reduces tire weight and minimizes rolling resistance for enhanced fuel efficiency.

EPA SmartWay® verified and CARB compliant.

### Recommended Application

An all-position tire recommended for steer applications in:

**Long Haul Service / Regional Haul Service**

**Replaces:** BF Goodrich: HW Control S  
Toyo: M137, M177  
General: HS

### TECHNICAL DATA

Tire Size	Load Range	Material Number	Weight (lbs.)	Meas. Rim	Overall Diam.	Overall Width	Static Loaded Radius	Overall Width (Loaded)	Revs Per Mile	Tread Depth (32')	Max. Tire Load (Single)		Max. Tire Load (Dual)		Max. Speed (MPH)
											Kg/kPa	Lbs/PSI	Kg/kPa	Lbs/PSI	
<b>FS509</b>															
11R22.5	G	013-817	111	8.25	41.3	11.3	19.2	12.5	503	19	2800@720	6175@105	2650@720	5840@105	75
11R24.5	G	013-825	114	8.25	43.3	11.4	20.2	12.5	480	19	3000@720	6610@105	2725@720	6005@105	75
295/75R22.5	G	013-816	109	8.25	40.2	11.5	18.8	12.6	516	19	2800@760	6175@110	2575@760	5675@110	75
285/75R24.5	G	013-823	107	8.25	41.4	11.3	19.4	12.4	502	19	2800@760	6175@110	2575@760	5675@110	75

- All dimensions taken with tire on measuring rim.
- Loaded dimensions and RPM measured at maximum dual load.
- For load and inflation tables see pages 61 through 65.
- For minimum dual spacing and approved rim widths see page 44.
- For ply ratings see table on page 42.

Firestone tires and tubes are subject to an ongoing development program. Bridgestone Americas Tire Operations, LLC retains the right to amend specifications at any time without notice or obligations. Please refer to rim manufacturer's load and inflation limits. Never exceed rim manufacturer's limits without the consent of the component manufacturer.



## FD609 Drive Tire

CLASSIC

- Aggressive center lugs help to improve traction in wet or dry conditions for the life of the tread.
- Tie bars control movement of center tread blocks to help minimize irregular wear, leading to longer original tread life.
- Optimized belt package achieves durability and retreadability while delivering reduced weight for improved rolling resistance and payload.
- Tough sidewall protection with thick ribs on both sidewalls to fight curbing damage to protect the casing.
- IntelliShape™ sidewall low bead filler volume reduces tire weight and minimizes rolling resistance for enhanced fuel efficiency

### Recommended Application

A drive tire recommended for tandem- and single-drive axle applications in:

**Long Haul Service / Regional Haul Service**

**Replaces:** BF Goodrich: DR444

Toyo: M647

General: HD



The Firestone FD609 meets 3 Peak Mountain Snow Flake (3PMSF) criteria for snow traction performance.

### TECHNICAL DATA

Tire Size	Load Range	Material Number	Weight (lbs.)	Meas. Rim	Overall Diam.	Overall Width	Static Loaded Radius	Overall Width (Loaded)	Revs Per Mile	Tread Depth (32')	Max. Tire Load (Single)		Max. Tire Load (Dual)		Max. Speed (MPH)
											Kg/kPa	Lbs/PSI	Kg/kPa	Lbs/PSI	
<b>FD609</b>															
11R22.5	G	013-819	125	8.25	41.8	11.3	19.5	12.5	497	29	2800@720	6175@105	2650@720	5840@105	75
11R24.5	G	013-827	129	8.25	43.9	11.4	20.5	12.5	473	29	3000@720	6610@105	2725@720	6005@105	75
295/75R22.5	G	013-818	118	8.25	40.7	11.5	19.0	12.6	510	29	2800@760	6175@110	2575@760	5675@110	75
285/75R24.5	G	013-826	122	8.25	42.0	11.3	19.7	12.4	495	29	2800@760	6175@110	2575@760	5675@110	75

- All dimensions taken with tire on measuring rim.
- Loaded dimensions and RPM measured at maximum dual load.
- For load and inflation tables see pages 61 through 65.
- For minimum dual spacing and approved rim widths see page 44.
- For ply ratings see table on page 42.

Firestone tires and tubes are subject to an ongoing development program. Bridgestone Americas Tire Operations, LLC retains the right to amend specifications at any time without notice or obligations. Please refer to rim manufacturer's load and inflation limits. Never exceed rim manufacturer's limits without the consent of the component manufacturer.



## FT409 Trailer Tire

CLASSIC

- Straight, flow-through grooves promote smooth rib-wear and evacuate water effectively for solid wet traction.
- Optimized belt package achieves durability and retreadability while delivering reduced weight for improved rolling resistance and payload. The FT409 provides a 17% improved rolling resistance vs. its predecessor.<sup>1</sup>
- Tough sidewall protection with thick ribs on both sidewalls to fight curbing damage to protect the casing.
- IntelliShape™ sidewall low bead filler volume reduces tire weight and minimizes rolling resistance for enhanced fuel efficiency.

EPA SmartWay® verified  
and CARB compliant.

### Recommended Application

A trailer tire recommended for applications in:  
**Long Haul Service / Regional Haul Service**

**Replaces:** BF Goodrich: HW Control T  
Toyo: M157  
General: HT

### TECHNICAL DATA

Tire Size	Load Range	Material Number	Weight (lbs.)	Meas. Rim	Overall Diam.	Overall Width	Static Loaded Radius	Overall Width (Loaded)	Revs Per Mile	Tread Depth (32')	Max. Tire Load (Single)		Max. Tire Load (Dual)		Max. Speed (MPH)
											Kg/kPa	Lbs/PSI	Kg/kPa	Lbs/PSI	
<b>FT409</b>															
11R22.5	G	013-821	101	8.25	41.4	10.6	19.4	11.7	502	12	2800@760	6175@105	2650@720	5840@105	75
295/75R22.5	G	013-820	99	8.25	40.3	10.7	18.8	11.8	516	12	2800@760	6175@110	2575@760	5675@110	75

<sup>1</sup> Comparison based on Firestone FT409 tire vs. Firestone FT455+ tire from internal testing. Results may vary.

- All dimensions taken with tire on measuring rim.
- Loaded dimensions and RPM measured at maximum dual load.
- For load and inflation tables see pages 61 through 65.
- For minimum dual spacing and approved rim widths see page 44.
- For ply ratings see table on page 42.

Firestone tires and tubes are subject to an ongoing development program. Bridgestone Americas Tire Operations, LLC retains the right to amend specifications at any time without notice or obligations. Please refer to rim manufacturer's load and inflation limits. Never exceed rim manufacturer's limits without the consent of the component manufacturer.



Standard Profile

Low-Profile



## FS560 PLUS

All-Position Tire



- Wide flow-through grooves and cross-rib sipes help to enhance traction.
- Wider tread spreads load over a larger area, distributing footprint pressure to promote long, smooth wear.
- Protector ribs on both sidewalls help resist cuts, snags, and abrasions from curbing and impacts.

### Recommended Application

An all-position tire recommended for steer applications and suitable for spread axle, heavy haul, high-scrub applications in:

**Regional Haul Service / Urban Service**

**Replaces:** BF Goodrich: Route Control S

Toyo: M170, M122

General: RA

### TECHNICAL DATA

Tire Size	Load Range	Material Number	Weight (lbs.)	Meas. Rim	Overall Diam.	Overall Width	Static Loaded Radius	Overall Width (Loaded)	Revs Per Mile	Tread Depth (32')	Max. Tire Load (Single)		Max. Tire Load (Dual)		Max. Speed (MPH)
											Kg/kPa	Lbs/PSI	Kg/kPa	Lbs/PSI	
<b>FS560 PLUS</b>															
11R22.5	G	156-531	114	8.25	41.3	10.8	19.3	11.8	503	19	2800@720	6175@105	2650@720	5840@105	75
11R22.5	H	156-558	114	8.25	41.3	10.8	19.3	11.8	503	19	3000@830	6610@120	2725@830	6005@120	75
11R24.5	G	156-574	122	8.25	43.3	10.7	20.3	11.7	480	19	3000@720	6610@105	2725@720	6005@105	75
11R24.5	H	156-582	122	8.25	43.3	10.7	20.3	11.7	480	19	3250@830	7160@120	3000@830	6610@120	75
255/70R22.5	H	192-982	93	8.25	36.7	10.3	17.1	11.3	567	18	2500@830	5510@120	2300@830	5070@120	75
295/75R22.5	G	156-566	111	8.25	40.3	10.9	18.8	11.8	515	19	2800@760	6175@110	2575@760	5675@110	75
285/75R24.5	G	156-590	116	8.25	41.5	10.6	19.5	11.9	501	19	2800@760	6175@110	2575@760	5675@110	75

- All dimensions taken with tire on measuring rim.
- Loaded dimensions and RPM measured at maximum dual load.
- For load and inflation tables see pages 61 through 65.
- For minimum dual spacing and approved rim widths see page 44.
- For ply ratings see table on page 42.

Firestone tires and tubes are subject to an ongoing development program. Bridgestone Americas Tire Operations, LLC retains the right to amend specifications at any time without notice or obligations. Please refer to rim manufacturer's load and inflation limits. Never exceed rim manufacturer's limits without the consent of the component manufacturer.

**CLASSIC**



# FD663

## Drive Tire



- Tie bars control movement of tread blocks to help minimize irregular wear tendencies, leading to long service life.
- Open-shoulder design helps to provide traction and grip in mud and snow.
- Four full-width steel belts help casing durability and enhance retreadability by combating casing penetration.
- Cap/base compounding combines a slow-wearing cap compound with a cool-running base that shields the casing from damaging heat to enhance retreadability.

### Recommended Application

A drive tire recommended for high traction and high-scrub drive axle applications in:  
**Regional Haul Service / Urban Service**

**Replaces:** BF Goodrich: Route Control D  
 Toyo: M610  
 General: RD



The Firestone FD663 meets 3 Peak Mountain Snow Flake (3PMSF) criteria for snow traction performance.

### TECHNICAL DATA

Tire Size	Load Range	Material Number	Weight (lbs.)	Meas. Rim	Overall Diam.	Overall Width	Static Loaded Radius	Overall Width (Loaded)	Revs Per Mile	Tread Depth (32')	Max. Tire Load (Single)		Max. Tire Load (Dual)		Max. Speed (MPH)
											Kg/kPa	Lbs/PSI	Kg/kPa	Lbs/PSI	
<b>FD663</b>															
10R22.5	F	281-034	110	7.50	40.5	9.8	18.9	10.8	513	25	2360@690	5205@100	2240@690	4940@100	75
11R22.5	G	281-042	125	8.25	41.9	10.7	19.5	11.8	496	26	2800@720	6175@105	2650@720	5840@105	75
11R22.5	H	211-206	125	8.25	41.9	10.8	19.5	11.9	496	26	3000@830	6610@120	2725@830	6005@120	75
11R24.5	G	281-069	133	8.25	43.9	10.7	20.5	11.8	473	26	3000@720	6610@105	2725@720	6005@105	75
11R24.5	H	293-733	134	8.25	43.9	10.7	20.5	11.8	473	26	3250@830	7160@120	3000@830	6610@120	75
12R22.5	H	151-009	154	9.00	43.0	11.6	20.0	12.6	483	26	3350@830	7390@120	3075@830	6780@120	75
295/75R22.5	G	281-050	117	8.25	40.6	11.1	18.9	12.2	512	26	2800@760	6175@110	2575@760	5675@110	75
285/75R24.5	G	281-077	122	8.25	41.9	10.6	19.6	11.7	496	26	2800@760	6175@110	2575@760	5675@110	75

- All dimensions taken with tire on measuring rim.
- Loaded dimensions and RPM measured at maximum dual load.
- For load and inflation tables see pages 61 through 65.
- For minimum dual spacing and approved rim widths see page 44.
- For ply ratings see table on page 42.

Firestone tires and tubes are subject to an ongoing development program. Bridgestone Americas Tire Operations, LLC retains the right to amend specifications at any time without notice or obligations. Please refer to rim manufacturer's load and inflation limits. Never exceed rim manufacturer's limits without the consent of the component manufacturer.



# Medium Truck Tire – Discontinued Products

## TIRE SPECIFICATIONS

Pattern	Size	Load Range	Material Number	Replace With	Meas. Rim	Overall Diam.	Overall Width	Static Loaded Radius	Loaded Width	Revs Per Mile	Tread Depth
<b>FS507 PLUS</b>	11R22.5	G	011-607	<b>FS509</b>	8.25	41.3	10.7	19.3	11.8	503	19
<b>FS507 PLUS</b>	11R24.5	G	011-608	<b>FS509</b>	8.25	43.4	10.6	20.3	11.7	478	19
<b>FS507 PLUS</b>	295/75R22.5	G	011-605	<b>FS509</b>	8.25	40.3	10.7	18.8	11.8	516	19
<b>FS507 PLUS</b>	285/75R24.5	G	011-606	<b>FS509</b>	8.25	41.4	10.6	19.4	11.7	502	19
<b>FS560 PLUS</b>	9R22.5	F	193-016	<b>FS561</b>	6.75	38.4	8.9	18.0	9.8	542	17
<b>FS560 PLUS</b>	10R22.5	F	211-274	<b>FS561</b>	7.50	40.1	9.8	18.7	10.8	518	18
<b>FS560 PLUS</b>	10R22.5	G	193-050	<b>FS561</b>	7.50	40.1	9.8	18.7	10.8	518	18
<b>FS560 PLUS</b>	12R22.5	H	156-523	<b>FS561</b>	9.00	42.7	11.6	19.8	12.6	487	19
<b>FS560 PLUS</b>	215/75R17.5	H	160-716	<b>FS561</b>	6.00	32.2	8.5	15.3	9.4	647	16
<b>FS560 PLUS</b>	225/70R19.5	F	208-860	-	6.00	32.2	8.5	15.3	9.4	647	16
<b>FS560 PLUS</b>	245/70R19.5 *	F	169-981	-	6.00	30.6	8.7	14.3	9.5	680	15
<b>FS560 PLUS</b>	245/70R19.5 *	G	169-964	-	6.75	33.3	9.4	15.7	10.3	624	17
<b>FS560 PLUS</b>	225/70R19.5	G	227-057	<b>FS561</b>	6.75	33.3	9.4	15.7	10.3	624	17
<b>FS560 PLUS</b>	275/70R22.5	H	192-999	<b>FS561</b>	8.25	38.0	10.8	17.6	11.8	547	18
<b>FS561</b>	9R22.5	F	248-562	<b>FS561A</b>	6.75	38.4	9	18	9.9	541	19
<b>FS561</b>	10R22.5	F	248-579	-	7.50	40.2	9.9	18.8	10.9	517	20
<b>FS561</b>	10R22.5	G	248-596	<b>FS561A</b>	7.50	40.2	9.9	18.8	10.9	517	20
<b>FS561</b>	11R22.5	G	248-307	<b>FS561A</b>	8.25	41.5	10.9	19.3	12	501	21
<b>FS561</b>	11R22.5	H	248-324	<b>FS561A</b>	8.25	41.5	10.9	19.3	12	501	21
<b>FS561</b>	11R24.5	G	248-358	<b>FS561A</b>	8.25	43.6	10.9	20.4	12	477	21
<b>FS561</b>	11R24.5	H	248-375	<b>FS561A</b>	8.25	43.6	10.9	20.4	12	477	21
<b>FS561</b>	12R22.5	H	248-494	<b>FS561A</b>	9.00	42.7	11.6	19.8	12.8	487	21
<b>FS561</b>	275/70R22.5	J	248-545	<b>FS561A</b>	8.25	38.1	11.5	17.9	12.7	545	21
<b>FS561</b>	295/75R22.5	G	248-273	<b>FS561A</b>	8.25	40.4	10.9	18.9	12	514	21
<b>FS561</b>	285/75R24.5	G	248-290	<b>FS561A</b>	8.25	41.5	10.9	19.5	12	501	21
<b>FS561</b>	255/70R22.5	H	248-528	<b>FS560 PLUS</b>	8.25	36.8	10.4	17.3	11.4	565	21
<b>FS590 PLUS</b>	11R22.5	G	296-902	<b>FS591</b>	8.25	41.3	10.8	19.2	11.8	503	18
<b>FS590 PLUS</b>	11R24.5	G	296-910	<b>FS591</b>	8.25	43.3	10.8	20.2	11.8	480	18
<b>FS590 PLUS</b>	295/75R22.5	G	296-929	<b>FS591</b>	8.25	40.1	10.8	18.7	11.8	518	18
<b>FS590 PLUS</b>	285/75R24.5	G	296-937	<b>FS591</b>	8.25	41.3	10.7	19.4	11.8	503	18
<b>FS400</b>	315/80R22.5 †	L	240-623	<b>FS400</b> (004-168)	9.00	42.4	12.4	19.7	13.9	490	18
<b>FD690 PLUS</b>	225/70R19.5	F	186-675	Transforce AT <sup>2</sup> Commercial	6.00	32.3	8.5	15.0	9.4	643	19
<b>FD690 PLUS</b>	225/70R19.5	G	227-074	Transforce AT <sup>2</sup> Commercial	6.00	32.3	8.5	15.0	9.4	643	19
<b>FD690 PLUS</b>	245/70R19.5	G	006-510	Transforce AT <sup>2</sup> Commercial	6.75	33.5	9.1	15.5	10.0	620	20
<b>FD690 PLUS</b>	11R22.5	G	006-504	<b>FD609</b>	8.25	42.1	10.8	19.6	11.8	493	29
<b>FD690 PLUS</b>	11R24.5	G	006-506	<b>FD609</b>	8.25	44.0	10.7	20.5	11.8	472	29
<b>FD690 PLUS</b>	295/75R22.5	G	006-514	<b>FD609</b>	8.25	41.0	11.1	19.1	12.2	507	29
<b>FD690 PLUS</b>	285/75R24.5	G	006-516	<b>FD609</b>	8.25	42.2	10.9	19.8	11.9	492	29

- All dimensions taken with tire on measuring rim.
- Loaded dimensions and RPM measured at maximum dual load.
- For load and inflation tables see pages 61 through 65.
- For minimum dual spacing and approved rim widths see page 44.
- For ply ratings see table on page 42.

Firestone tires and tubes are subject to an ongoing development program. Bridgestone Americas Tire Operations, LLC retains the right to amend specifications at any time without notice or obligations. Please refer to rim manufacturer's load and inflation limits. Never exceed rim manufacturer's limits without the consent of the component manufacturer.



# Medium Truck Tire – Discontinued Products

## TIRE SPECIFICATIONS

Pattern	Size	Load Range	Material Number	Replace With	Meas. Rim	Overall Diam.	Overall Width	Static Loaded Radius	Loaded Width	Revs Per Mile	Tread Depth
<b>FD691</b>	11R22.5	G	241-558	<b>FD692</b>	8.25	41.7	11.2	19.4	12.3	498	26
<b>FD691</b>	11R24.5	G	241-575	<b>FD692</b>	8.25	43.6	11.1	20.35	12.24	477	26
<b>FD691</b>	295/75R22.5	G	241-524	<b>FD692</b>	8.25	40.4	11.1	18.9	12.4	514	26
<b>FD691</b>	285/75R24.5	G	241-541	<b>FD692</b>	8.25	41.7	11.2	19.55	12.3	499	26
<b>FD711</b>	11R22.5	G	009-056	<b>FD711</b>	8.25	41.9	10.7	19.6	11.8	496	26
<b>FD711</b>	11R24.5	G	009-057	<b>FD711</b>	8.25	43.9	10.7	20.6	11.8	473	26
<b>FT455 PLUS</b>	295/75R22.5	G	011-609	<b>FT409</b>	8.25	39.9	10.9	18.6	12.0	521	12
<b>FT455 PLUS</b>	11R22.5	G	011-611	<b>FT409</b>	8.25	41.0	10.7	19.1	11.8	506	12
<b>FT491</b>	11R22.5	G	006-634	<b>FT492</b>	8.25	40.9	11.3	19.1	12.5	507	11
<b>FT491</b>	11R24.5	G	006-635	<b>FT492</b>	8.25	42.9	11.4	20.1	12.5	485	11
<b>FT491</b>	255/70R22.5	H	006-636	<b>FT492</b>	8.25	36.3	10.4	17.1	11.5	572	11
<b>FT491</b>	295/75R22.5	G	006-638	<b>FT492</b>	8.25	39.7	11.3	18.6	12.5	523	11
<b>FT491</b>	285/75R24.5	G	006-640	<b>FT492</b>	8.25	41.0	11.3	19.3	12.4	507	11
<b>FT491</b>	11R22.5	G	238-668	<b>FT492</b>	8.25	40.9	11.3	19.1	12.5	507	11
<b>FT491</b>	11R24.5	G	238-685	<b>FT492</b>	8.25	42.9	11.4	20.1	12.5	485	11
<b>FT491</b>	255/70R22.5	H	238-702	<b>FT492</b>	8.25	36.3	10.4	17.1	11.5	572	11
<b>FT491</b>	295/75R22.5	G	238-617	<b>FT492</b>	8.25	39.7	11.3	18.6	12.5	523	11
<b>FT491</b>	285/75R24.5	G	238-634	<b>FT492</b>	8.25	41.0	11.3	19.3	12.4	507	11
<b>FS820</b>	11R22.5	H	241-252	<b>FS821</b>	8.25	42	11.0	19.5	12.1	495	24
<b>FS820</b>	11R24.5	H	233-840	<b>FS821</b>	8.25	44.0	10.9	20.5	12.0	472	24
<b>FS820</b>	315/80R22.5 †	L	233-874	<b>FS821</b>	9.00	42.9	12.7	19.9	13.9	484	26
<b>T819</b>	10.00R20	H	294-497	-	7.50	41.5	10.6	19.3	11.6	501	20
<b>T819</b>	11.00R20	H	294-500	-	8.00	42.6	11.5	19.8	12.5	486	20
<b>T819</b>	11.00R22	H	294-527	-	8.00	44.7	11.4	20.8	12.5	465	20
<b>T819</b>	12.00R20	J	294-519	-	8.50	44.8	12.3	20.7	13.4	464	21
<b>T831</b>	10.00R20	H	281-549	-	7.50	42.3	10.8	19.7	11.8	491	31
<b>T831</b>	11.00R20	H	281-573	-	8.00	43.5	11.4	20.2	12.5	478	31
<b>T839</b>	385/65R22.5	J	294-586	-	11.75	42.5	15.2	19.7	16.6	492	17
<b>T839</b>	425/65R22.5	L	294-594	-	12.25	44.5	16.3	20.5	17.7	470	18
<b>T839</b>	445/65R22.5	L	294-608	-	13.00	45.7	17.4	21.0	19.0	458	18

† 315/80R22.5 requires the use of a 9.00 rim to carry over 8000 lb.

- All dimensions taken with tire on measuring rim.
- Loaded dimensions and RPM measured at maximum dual load.
- For load and inflation tables see pages 61 through 65.
- For minimum dual spacing and approved rim widths see page 44.
- For ply ratings see table on page 42.

Firestone tires and tubes are subject to an ongoing development program. Bridgestone Americas Tire Operations, LLC retains the right to amend specifications at any time without notice or obligations. Please refer to rim manufacturer's load and inflation limits. Never exceed rim manufacturer's limits without the consent of the component manufacturer.



## **Commercial Light Truck Tires**

<b>Light Truck Tire Size &amp; Availability Chart. ....</b>	<b>36</b>
<b>Transforce HT<sup>2</sup> / CV .....</b>	<b>37</b>
<b>Transforce AT<sup>2</sup> .....</b>	<b>38</b>
<i>Commercial Light Truck Tire – Discontinued Products.....</i>	<i>39 - 40</i>

# Light Truck Tire Size & Availability Chart

LOAD RANGE AND TREAD DEPTHS IN 32NDS INDICATE AVAILABILITY			
FIRESTONE	TRANSFORCE HT <sup>2</sup>	TRANSFORCE CV	TRANSFORCE AT <sup>2</sup>
PAGE	37	37	38
REPLACES BF GOODRICH	T/A All Season	T/A All Season	T/A Traction
REPLACES GOODYEAR	Workhorse MSD	Workhorse MSD	Wrangler Duratrac
SIZE	LOAD-TREAD DEPTH		
205/65R15C		C-14	
195/75R16C		D-12	
225/75R16C		E-12	
235/65R16C		E-13	
215/55R16		XL-12	
215/50R17		XL-12	
LT215/85R16	E-14		E-16
LT225/75R16	E-14		E-16
LT235/85R16	E-15		E-17
LT245/75R16	E-14		E-17
LT265/75R16	E-15		E-17
LT225/75R17	E-14		E-16
LT235/80R17	E-15		E-17
LT245/70R17	E-14		E-17
LT245/75R17	E-14		E-17
LT265/70R17	E-15		E-17
LT285/70R17	E-16		E-18
LT265/70R18	E-15		E-17
LT275/65R18	E-16		E-16
LT275/70R18	E-16		E-18
LT265/60R20	E-15		E-15
LT275/65R20	E-16		E-16
LT285/60R20	E-16		



## Transforce HT<sup>2</sup> / CV

- Delivers solid traction in wet conditions to help reduce the risk of hydroplaning.
- Tread design provides great chip and tear resistance.
- Optimized tire profile to help improve uneven wear, even with heavy loads.
- Saw tooth edge siping provide biting edges in snow while maintaining block stiffness

**Replaces:** BF Goodrich: T/A All Season  
Goodyear: Workhorse MSD

### TECHNICAL DATA

SW Style	Tire Size	Load Range	Service Description	Material Number	Wt. (lbs.)	Measuring Rim	Overall Diam.	Overall Width	Static Loaded Radius	Min. Dual Spac.	Revs Per Mile	Tread Depth (32')	Max. Tire Load (Single)		Max. Tire Load (Dual)	
													Kg/kPa	Lbs/PSI	Kg/kPa	Lbs/PSI
<b>Transforce HT<sup>2</sup></b>																
BW	LT215/85R16	E	115/112R	002758	36.9	(6.0)5.5-7.0	30.4	8.5	13.5	9.9	685	14	1215@550	2680@80	1120@550	2470@80
BW	LT235/85R16	E	120/116R	002759	39.7	(6.5)6.0-7.5	31.7	9.3	14.0	10.8	656	15	1380@550	3042@80	1260@550	2778@80
BW	LT225/75R16	E	115/112R	002760	34.7	(6.0)6.0-7.0	29.3	8.8	13.1	10.2	711	14	1215@550	2680@80	1120@550	2470@80
BW	LT245/75R16	E	120/116R	002761	39.1	(7.0)6.5-8.0	30.5	9.8	13.5	11.3	684	14	1380@550	3042@80	1260@550	2778@80
BW	LT265/75R16	E	123/120R	002762	44.3	(7.5)7.0-8.0	31.7	10.5	14.0	12.2	658	15	1549@550	3415@80	1399@550	3085@80
BW	LT235/80R17	E	120/117R	002766	42.6	(6.5)6.0-7.0	31.8	9.3	14.2	10.8	655	15	1399@550	3085@80	1286@550	2835@80
BW	LT225/75R17	E	116/113R	002774	36.5	(6.0)6.0-7.5	30.3	8.8	13.6	10.2	687	14	1249@550	2755@80	1150@550	2535@80
BW	LT245/75R17	E	121/118R	002777	41.0	(7.0)6.5-7.5	31.5	9.8	14.1	11.3	661	14	1449@550	3195@80	1320@550	2910@80
BW	LT245/70R17	E	119/116R	002767	40.9	(7.0)6.5-8.0	30.6	9.8	13.7	11.3	682	14	1361@550	3000@80	1249@550	2755@80
BW	LT265/70R17	E	121/118R	13870	43.8	(8.0)7.0-8.5	31.7	10.7	14.1	12.4	658	15	1449@550	3195@80	1320@550	2910@80
BW	LT285/70R17	E	121/118R	004371	51.5	(8.5)7.0-9.0	32.8	11.5	14.5	13.4	636	16	1449@550	3195@80	1320@550	2910@80
BW	LT265/70R18	E	124/121R	13869	46.7	(8.0)7.0-9.0	32.6	10.7	14.6	12.4	638	15	1599@550	3525@80	1449@550	3195@80
BW	LT275/70R18	E	125/122S	002778	51.3	(8.0)7.0-8.5	33.2	11.0	14.8	12.8	628	16	1651@550	3640@80	1499@550	3305@80
BW	LT275/65R18	E	123/120S	13987	47.4	(8.0)7.5-9.0	32.1	11.0	14.5	12.8	649	16	1549@550	3415@80	1399@550	3085@80
BW	LT275/65R20	E	126/123S	004369	50.9	(8.0)7.5-9.5	34.1	11.0	15.5	12.8	611	16	1701@550	3750@80	1549@550	3415@80
BW	LT265/60R20	E	121/118S	004372	47.8	(8.0)7.5-9.5	32.5	10.7	14.9	12.4	641	15	1449@550	3195@80	1320@550	2910@80
BW	LT285/60R20	E	125/122R	005286	52.4	(8.5)8.0-10.0	33.5	11.5	15.2	13.4	623	16	1651@550	3640@80	1499@550	3305@80
<b>Transforce CV</b>																
BW	205/65R15C	C	102/100T	004706	27.1	(6.0)5.5-6.5	25.5	8.2	11.6	9.5	817	14	850@550	1874@80	800@550	1764@80
BW	195/75R16C	D	107/105R	004708	26.8	(5.5)5.0-6.0	27.5	7.7	12.4	8.9	758	12	975@550	2149@80	925@550	2039@80
BW	225/75R16C	E	121/120R	011488	35.6	(6.0)6.0-7.0	29.3	8.9	13.1	10.1	435	12	1449@550	3195@80	1400@550	3086@80
BW	235/65R16C	E	121/119R	004709	36.2	(7.0)6.5-8.5	28.0	9.5	12.7	10.9	743	13	1450@550	3197@80	1360@550	2998@80
BW	215/55R16	XL	97H	008699	25.3	(7.0)6.0-7.5	25.3	8.9	11.6	-	824	12	730@550	1609@80	-	-
BW	215/50R17	XL	95H	008698	25.5	(7.0)6.0-7.5	25.5	8.0	11.8	-	817	12	690@550	1521@80	-	-

- All dimensions taken with tire on measuring rim (in parenthesis above).
- Loaded dimensions and RPM measured at maximum dual load.
- For load and inflation tables see pages 66 through 69.

Firestone tires and tubes are subject to an ongoing development program. Bridgestone Americas Tire Operations, LLC retains the right to amend specifications at any time without notice or obligations. Please refer to rim manufacturer's load and inflation limits. Never exceed rim manufacturer's limits without the consent of the component manufacturer.



## Transforce AT<sup>2</sup>

- Built with a chip and tear resistant compound — tough enough to deal with rough road conditions.
- Deeper tread features improve traction in rain, snow and dry conditions.
- Pattern features combined with an innovative tread-to-road contact footprint help performance for longer tire life.
- High ratings on wet and off-road performance.

**Replaces:** BF Goodrich: T/A Traction  
Goodyear: Wrangler Duratrac

### TECHNICAL DATA

SW Style	Tire Size	Load Range	Service Description	Material Number	Wt. (lbs.)	Measuring Rim	Overall Diam.	Overall Width	Static Loaded Radius	Min. Dual Spac.	Revs Per Mile	Tread Depth (32')	Max. Tire Load (Single)		Max. Tire Load (Dual)	
													Kg/kPa	Lbs/PSI	Kg/kPa	Lbs/PSI
<b>Transforce AT<sup>2</sup></b>																
BW	LT215/85R16	E	115/112R	000178	36.7	(6.0)5.5-7.0	30.4	8.5	13.5	9.9	685	16	1215@550	2680@80	1120@550	2470@80
BW	LT225/75R16	E	115/112R	000180	36.4	(6.0)6.0-7.0	29.3	8.8	13.1	10.2	711	16	1215@550	2680@80	1120@550	2470@80
BW	LT235/85R16	E	120/116R	000179	41.3	(6.5)6.0-7.5	31.7	9.3	14.0	10.8	656	17	1380@550	2042@80	1250@550	2755@80
BW	LT245/75R16	E	120/116R	000181	41.3	(7.0)6.5-8.0	30.5	9.8	13.5	11.3	684	17	1380@550	3042@80	1250@550	2755@80
BW	LT265/75R16	E	123/120R	000182	43.5	(7.5)7.0-8.0	31.7	10.5	14.0	12.2	658	17	1550@550	3415@80	1400@550	3085@80
BW	LT225/75R17	E	116/113R	000183	37.8	(6.0)6.0-7.5	30.3	8.8	13.6	10.2	687	16	1250@550	2755@80	1150@550	2535@80
BW	LT235/80R17	E	120/117R	000185	41.4	(6.5)6.0-7.5	31.8	9.3	14.2	10.8	655	17	1400@550	3085@80	1285@550	2755@80
BW	LT245/70R17	E	119/116R	000186	41.0	(7.0)6.5-8.0	30.6	9.8	13.7	11.3	682	17	1360@550	3000@80	1250@550	2755@80
OWL	LT245/75R17	E	121/118R	000184	43.1	(7.0)6.5-7.5	31.5	9.8	14.1	11.3	661	17	1450@550	3195@80	1320@550	2910@80
BW	LT265/70R17	E	121/118R	13868	44.7	(8.0)7.0-8.5	31.7	10.7	14.1	12.4	658	17	1450@550	3195@80	1320@550	2910@80
BW	LT285/70R17	E	121/118R	000780	50.1	(8.5)7.5-9.0	32.8	11.5	14.5	13.4	636	18	1450@550	3195@80	1320@550	2910@80
BW	LT265/70R18	E	124/121R	000188	49.5	(8.0)7.0-9.0	32.6	10.7	14.6	12.4	638	17	1600@550	3525@80	1450@550	3195@80
BW	LT275/65R18	E	123/120R	13988	48.3	(8.0)7.5-9.0	32.1	11.0	14.5	12.8	649	16	1550@550	3415@80	1400@550	3085@80
BW	LT275/70R18	E	125/122R	13989	51.2	(8.0)7.0-8.5	33.2	11.0	14.8	12.8	628	18	1650@550	3640@80	1500@550	3305@80
BW	LT265/60R20	E	121/118R	000192	47.0	(8.0)7.5-9.5	32.5	10.7	14.9	12.4	641	15	1450@550	3195@80	1320@550	2910@80
BW	LT275/65R20	E	126/123R	000191	51.2	(8.0)7.5-9.5	34.1	11.0	15.5	12.8	611	16	1700@550	3750@80	1550@550	3415@80

- All dimensions taken with tire on measuring rim (in parenthesis above).
- Loaded dimensions and RPM measured at maximum dual load.
- For load and inflation tables see pages 66 through 69.

Firestone tires and tubes are subject to an ongoing development program. Bridgestone Americas Tire Operations, LLC retains the right to amend specifications at any time without notice or obligations. Please refer to rim manufacturer's load and inflation limits. Never exceed rim manufacturer's limits without the consent of the component manufacturer.

# Commercial Light Truck — Discontinued Products

## TIRE SPECIFICATIONS

Pattern	Size	Load Range	Measuring Rims	Overall Diameter	Overall Width	Static Loaded Radius	Revs Per Mile	Min. Duel Spacing	Tread Depth (32")
Transforce HT2	LT265/70R17	E	(8.0)7.0-8.5	31.7	10.7	14.1	658	12.4	15
Transforce HT2	LT265/70R18	E	(8.0)7.0-9.0	32.6	10.7	14.6	638	12.4	15
Transforce HT2	LT275/65R18	E	(8.0)7.5-9.0	32.1	11.0	14.5	649	12.8	16
Transforce AT2	LT265/70R17	E	(8.0)7.0-8.5	31.7	10.7	14.1	658	12.4	17
Transforce AT2	LT275/65R18	E	(8.0)7.5-9.0	32.1	11.0	14.5	649	12.8	16
Transforce AT2	LT275/70R18	E	(8.0)7.0-8.5	33.2	11.0	14.8	628	12.8	18
Steeltex R4S	7.00R15LT	D	5.50	29.6	8.0	13.7	704	9.0	13
Steeltex R4S	8.75R16.5LT	D/E	6.75	29.5	8.8	13.8	706	9.9	14
Steeltex R4S	9.50R16.5LT	D/E	6.75	30.6	9.5	14.2	681	10.7	14
Steeltex R4S	LT215/85R16	D/E	6.00	30.4	8.5	13.5	685	9.9	13
Steeltex R4S	LT235/85R16	D	6.50	31.7	9.3	14.0	657	10.8	14
Steeltex R4S	LT225/75R16	C/D/E	6.00	29.3	8.8	13.1	711	10.2	13
Steeltex R4S	LT245/75R16	C/E	7.00	30.5	9.8	13.6	683	11.3	14
Steeltex R4S	LT265/75R16 II	D	7.50	31.7	10.5	14.0	657	12.2	14
Steeltex R4S	LT215/75R15	C	6.00	27.7	8.5	12.4	752	9.9	13
Steeltex R4S	LT235/75R15	C	6.50	28.9	9.3	12.8	721	10.8	12
Steeltex R4S	LT225/75R16 II	E	6.00	29.3	8.8	13.1	711	10.2	13
Steeltex R4S	LT245/75R16 II	E	7.00	30.5	9.8	13.6	683	11.3	14
Steeltex R4S	7.50R16LT	D	6.00	31.8	8.7	14.7	655	10.0	13
Steeltex R4S	8.00R16.5LT	D	6.00	28.3	8.0	13.3	736	9.0	13
Steeltex A/T	7.50R16LT	D	6.00	31.8	8.7	14.7	655	10.0	17
Steeltex A/T	LT245/75R16	C/E	7.00	30.5	9.8	13.6	683	11.3	14/16
Steeltex A/T	LT265/75R16	D/E	7.50	31.7	10.5	14.0	657	12.2	18
Steeltex A/T	LT235/85R16	D	6.50	31.7	9.3	14.0	657	10.8	17
Steeltex A/T	8.00R16.5LT	D	6.00	28.3	8.0	13.3	736	9.0	17
Steeltex A/T	8.75R16.5LT	D/E	6.75	29.5	8.8	13.8	706	9.9	17
Steeltex A/T	9.50R16.5LT	D/E	6.75	30.6	9.5	14.2	681	10.7	18
Steeltex A/T	LT235/75R15	C	6.50	28.9	9.3	12.8	721	10.8	17
Steeltex A/T	LT225/75R16	D	6.00	29.3	8.8	13.1	711	10.2	17
Steeltex A/T	LT215/85R16	D	6.00	30.4	8.5	13.5	685	9.9	17
Steeltex 23° SPS	LT235/75R15	C	6.50	28.9	9.3	12.8	721	10.8	17
Steeltex 23° SPS	LT225/75R16	D	6.00	29.3	8.8	13.1	711	10.2	16
Steeltex 23° SPS	LT245/75R16	E	7.00	30.5	9.8	13.6	683	11.3	17
Steeltex 23° SPS	LT215/85R16	D	6.00	30.4	8.5	13.5	685	9.9	17
Steeltex 23° SPS	LT235/85R16	E	6.50	31.7	9.3	14.0	657	10.8	17
Steeltex 23° SPS	9.50R16.5LT	D	6.75	30.6	9.5	14.2	681	10.7	17
Transforce HT	LT215/85R16	D	6.0	30.4	8.5	14.1	686	9.9	14
Transforce HT	LT225/75R16	D	6.0	29.3	8.8	13.6	712	10.2	14
Transforce HT	LT235/75R17	E	6.50	31.8	9.3	14.8	656	10.8	15
Transforce AT	LT225/75R16	D	6.0	29.5	8.8	13.8	706	10.2	16
Transforce AT	LT275/65R18	E	8.0	32.1	10.9	14.9	651	12.8	17
Transforce AT / BL	LT235/75R15	C	(6.5) 6.0-7.0	28.9	9.3	12.8	716	10.8	17
Transforce AT / BL	LT215/85R16	E	(6.0) 5.5-7.0	30.4	8.5	13.5	681	9.9	17
Transforce AT / BL	LT235/85R16	E	(6.5) 6.0-7.5	31.7	9.3	14.0	651	10.8	16
Transforce AT / BL	LT225/75R16	E	(6.0) 6.0-7.0	29.3	8.8	13.1	706	10.2	16
Transforce AT / BL	LT245/75R16	E	(7.0) 6.5-8.0	30.5	9.8	13.5	679	11.3	16
Transforce AT / BL	LT265/75R16	E	(7.5) 7.0-8.0	31.7	10.5	14.0	653	12.2	17
Transforce AT / OWL	LT265/75R16	E	(7.5) 7.0-8.0	31.7	10.5	14.0	653	12.2	18
Transforce AT / BL	LT235/80R17	E	(6.5) 6.0-7.5	31.8	9.3	14.2	655	10.8	17

# Commercial Light Truck — Discontinued Products

## TIRE SPECIFICATIONS

Pattern	Size	Load Range	Measuring Rims	Overall Diameter	Overall Width	Static Loaded Radius	Revs Per Mile	Min. Duel Spacing	Tread Depth (32')
Transforce AT / BL	LT225/75R17	E	(6.0) 6.0-7.5	30.3	8.8	13.6	681	10.2	17
Transforce AT / OWL	LT245/75R17	E	(7.0) 6.5-7.5	31.5	9.8	14.1	661	11.3	17
Transforce AT / BL	LT245/70R17	C	(7.0) 6.5-8.0	30.6	9.8	13.7	676	11.3	16
Transforce AT / BL	LT245/70R17	E	(7.0) 6.5-8.0	30.6	9.8	13.7	676	11.3	17
Transforce AT / BL	LT265/70R17	E	(8.0) 7.0-8.5	31.7	10.7	14.1	658	12.4	17
Transforce AT / OWL	LT265/70R17	E	(8.0) 7.0-8.5	31.7	10.7	14.7	653	12.4	18
Transforce AT / OWL	LT275/70R18	E	(8.0) 7.0-8.5	33.2	11	14.8	627	12.8	16
Transforce AT / OWL	LT275/70R18	E	(8.0) 7.0-8.5	33.2	11	14.8	627	12.8	15
Transforce AT / OWL	LT275/65R18	E	(8.0) 7.5-9.0	32.1	11	14.5	649	12.8	13
Transforce AT / OWL	LT285/60R20	E	(8.5) 8.0-10.0	33.5	11.5	15.2	603	13.4	16
Transforce HT / BL	LT235/75R15	C	(6.5) 6.0-7.0	28.9	9.3	12.8	721	10.8	15
Transforce HT / BL	205/65R15C	C	(6.0) 5.5-6.5	25.5	8.2	11.6	817	9.4	14
Transforce HT / BL	LT215/85R16	E	(6.0) 5.5-7.0	30.4	8.5	13.5	685	9.9	14
Transforce HT / BL	LT235/85R16	E	(6.5) 6.0-7.5	31.7	9.3	14.0	657	10.8	14
Transforce HT / BL	195/75R16C	D	(5.5) 5.0-6.0	27.5	7.7	12.4	758	8.9	12
Transforce HT / BL	LT225/75R16	E	(6.0) 6.0-7.0	29.3	8.8	13.1	711	10.2	14
Transforce HT / BL	LT245/75R16	E	(7.0) 6.5-8.0	30.5	9.8	13.5	684	11.3	14
Transforce HT / OWL	LT265/75R16	E	(7.5) 7.0-8.0	31.7	10.5	14.0	657	12.2	15
Transforce HT / BL	LT265/75R16	E	(7.5) 7.0-8.0	31.7	10.5	14.0	657	12.2	15
Transforce HT / BL	235/65R16C	E	(7.0) 6.5-8.5	28.0	9.5	12.7	743	10.9	13
Transforce HT / BL	8.75R16.5LT	E	(6.75) 6.0-6.75	29.5	8.8	13.2	706	9.9	15
Transforce HT / BL	9.50R16.5LT	E	(6.75) 6.75-8.25	30.6	9.5	13.6	681	10.7	15
Transforce HT / BL	LT235/80R17	E	(6.5) 6.0-7.5	31.8	9.3	14.2	655	10.8	14
Transforce HT / BL	LT225/75R17	E	(6.0) 6.0-7.5	30.3	8.8	13.6	687	10.2	14
Transforce HT / BL	LT245/75R17	E	(7.0) 6.5-7.5	31.5	9.8	14.1	661	11.3	12
Transforce HT / BL	LT245/75R17	E	(7.0) 6.5-7.5	31.5	9.8	14.1	661	11.3	13
Transforce HT / BL	LT245/75R17	E	(7.0) 6.5-7.5	31.5	9.8	14.1	661	11.3	13
Transforce HT / OWL	LT245/75R17	E	(7.0) 6.5-7.5	31.5	9.8	14.1	661	11.3	13
Transforce HT / BL	LT245/70R17	E	(7.0) 6.5-8.0	30.6	9.8	13.7	681	11.3	14
Transforce HT / BL	LT245/70R17	E	(7.0) 6.5-8.0	30.6	9.8	13.7	681	11.3	14
Transforce HT / OWL	LT265/70R17	E	(8.0) 7.0-8.5	31.7	10.7	14.7	657	12.4	14
Transforce HT / OWL	LT265/70R18	E	(8.0) 7.0-9.0	32.6	10.7	14.6	638	12.4	15
Transforce HT / OWL	LT275/70R18	E	(8.0) 7.0-8.5	33.2	11	14.8	627	12.8	15
Transforce HT / BL	LT275/70R18	E	(8.0) 7.0-8.5	33.2	11	14.8	608	12.8	16
Transforce HT / OWL	LT275/65R18	E	(8.0) 7.5-9.0	32.1	11	14.5	649	12.8	17



## **General Technical Information**

<b>Adjustment Treadwear Chart</b> .....	42
<b>Truck Tire Limited Warranty</b> .....	43 - 50
<b>Commercial Tire Tubes, Valves &amp; Flaps</b> .....	51
<b>Radial &amp; Bias Tire Construction</b> .....	51
<b>Definitions</b> .....	52 - 53
<b>Ply Rating/Load Range</b> .....	53
<b>Speed Symbol</b> .....	54
<b>International Load Index Numbers</b> .....	54
<b>Inflation Pressure</b> .....	55
<b>Tire Mixing</b> .....	55
<b>Dual Matching</b> .....	55
<b>Medium Truck Tire Approved Rim Width &amp; Minimum Dual Spacing</b> .....	56
<b>Tire Rotation</b> .....	57
<b>Regrooving</b> .....	57
<b>Branding</b> .....	57
<b>Wheel Alignment</b> .....	58
<b>Balance/Runout</b> .....	59 - 60
<b>Tire Mounting for Low Vibration</b> .....	60 - 61
<b>Storage</b> .....	62
<b>Tire Inspection</b> .....	62
<b>Irregular Wear of Radial Truck Tires</b> .....	62
<b>Low Profile Tires</b> .....	63
<b>Mounting/Demounting Procedures</b> .....	64 - 65
<b>Tire Vibration</b> .....	66
<b>Repair &amp; Retreading</b> .....	66
<b>Large Truck Fuel Economy</b> .....	67 - 71
<b>Truck Type by Weight Class</b> .....	72

# Adjustment Treadwear Chart

## ORIGINAL TREAD DEPTH

REMAINING TREAD DEPTH	9	10	11	12	13	14	15	16	17	18	19	20	21	22	23	24	25	26	27	28	29	30	31	32	33	34	REMAINING TREAD DEPTH
	<b>Percentage of Usable Tread Wear Charges to the Customer</b>																										
2/32	100%	100	100	100	100	100	100	100	100	100	100	100	100	100	100	100	100	100	100	100	100	100	100	100	100	100	2/32
3/32	86%	88	89	90	91	92	92	93	93	94	94	94	95	95	95	96	96	96	96	96	96	96	97	97	97	97	3/32
4/32	71%	75	78	80	82	83	85	86	87	88	88	89	89	90	90	91	91	92	92	92	93	93	93	93	94	94	4/32
5/32	57%	63	67	70	73	75	77	79	80	81	82	83	84	85	86	86	87	88	88	88	89	89	90	90	90	91	5/32
6/32	43%	50	58	60	64	67	69	71	73	75	76	78	79	80	81	82	83	83	84	85	85	86	86	87	87	88	6/32
7/32	29%	38	44	50	55	58	62	64	67	69	71	72	73	75	76	77	78	79	80	81	81	82	83	83	84	84	7/32
8/32	14%	25	33	40	45	50	54	57	60	63	65	67	68	70	71	73	74	75	76	77	78	79	79	80	81	81	8/32
9/32	0%	13	22	30	36	42	46	50	53	56	59	61	63	65	67	68	70	71	72	73	74	75	76	77	77	78	9/32
10/32		0	11	20	27	33	38	43	47	50	53	56	58	60	62	64	65	67	68	69	70	71	72	73	74	75	10/32
11/32			0	10	18	25	31	36	40	44	47	50	53	55	57	59	61	63	64	65	67	68	69	70	71	72	11/32
12/32				0	9	17	23	25	33	38	41	44	47	50	52	55	57	58	60	62	63	64	66	67	68	69	12/32
13/32					0	8	15	21	29	31	35	39	42	45	48	50	52	54	56	58	59	61	62	63	65	66	13/32
14/32						0	8	14	20	25	29	33	37	40	43	45	48	50	52	54	56	57	59	60	61	63	14/32
15/32							0	7	13	19	24	28	32	35	38	41	43	46	48	50	52	54	55	57	58	59	15/32
16/32								0	7	13	17	22	26	30	33	36	39	42	44	46	48	50	52	53	55	56	16/32
17/32									0	6	12	18	21	25	29	32	35	38	40	42	44	46	48	50	52	53	17/32
18/32										0	6	11	16	20	24	27	30	33	36	38	41	43	45	47	48	50	18/32
19/32											0	6	11	15	19	23	26	29	32	35	37	39	41	43	45	47	19/32
20/32												0	5	10	14	18	22	25	28	31	33	36	38	40	42	44	20/32
21/32													0	5	10	14	17	21	24	27	30	32	34	37	39	41	21/32
22/32														0	5	9	13	17	20	23	26	29	31	33	35	38	22/32
23/32															0	5	9	13	16	19	22	25	28	30	32	34	23/32
24/32																0	4	8	12	15	19	21	24	27	29	31	24/32
25/32																	0	4	8	12	15	18	21	23	26	28	25/32
26/32																		0	4	8	11	14	17	20	23	25	26/32
27/32																			0	4	7	11	14	17	19	22	27/32
28/32																				0	4	7	10	13	16	19	28/32
29/32																					0	4	7	10	13	16	29/32
30/32																						0	3	7	10	13	30/32
31/32																							0	3	6	9	31/32
32/32																								0	3	6	32/32
33/32																									0	3	33/32
34/32																										0	34/32

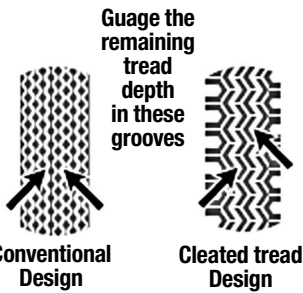

### How To Calculate Adjusted Prices

1. Find the original tread depth in the price/data book.
2. Using 32nds gauge, measure the remaining tread at three points in the two center grooves and average the three measurements.
3. Where the averaged tread depth remaining line meets the appropriate original tread depth column, the percentage of tread worn off the tire will be found.
4. Use this percentage to calculate the customer's replacement price.

### With a tire-marking crayon, mark on the adjusted tire:

1. Location of the service condition (circled).
2. Adjustment Claim Number
3. Retailer Name
4. Rub across the DOT serial number so it can be easily read.

**Make sure the customer COMPLETES and SIGNS the CUSTOMER section of the Adjustment Form!**

# Truck Tire Limited Warranty & Safety Manual

For the latest tire warranty information, visit [commercial.firestone.com](http://commercial.firestone.com)

To ensure optimum tire performance and reduce the risk of a tire failure, Bridgestone Americas Tire Operations, LLC (“BRIDGESTONE”) strongly recommends you read and follow all maintenance and safety information contained in this manual. In addition, we recommend periodic inspection and maintenance, if necessary, by a qualified tire service professional.

## LIMITED WARRANTY FIRESTONE BRAND TRUCK TIRES

### Eligibility

You are covered under the terms of this Limited Warranty if all of the following apply:

- You are the original owner, or original owner’s authorized agent, of any new FIRESTONE brand truck tire bearing a Department of Transportation (DOT) tire identification number indicating manufacture after January 1, 2019 (DOT serial 0119 or later).
- The tire was purchased after August 1, 2019 and used primarily in the U.S. For tires covered prior to this time, please refer to the limited warranty that would have been in effect at the time of original sale.
- The tire size, load range, and speed rating are equivalent to or greater than, that specified or recommended for use by the vehicle manufacturer or BRIDGESTONE.
- The new tire was approved for sale in the United States, listed in a U.S. price or data book, and purchased from an authorized FIRESTONE brand truck tire retailer.
- For coverage under the Enhanced Casing Credit Limited Warranty, the eligible tire must have been used only in long haul, regional, pick up and delivery (P&D) highway service for the entire life of the casing and subsequent retread(s) must be inspected and retreaded by an authorized Bandag dealer only.
- Proper tire inflation pressure, as specified by the vehicle manufacturer to operate the vehicle within tire/vehicle load capacity, have been maintained.
- Proper wheel alignment and tire/wheel assembly balance have been maintained.
- The tire has been operated within the speed limitations of the tire.

### What Is Warranted and For How Long

Upon examination by BRIDGESTONE, and subject to terms and conditions stated herein, before wearing down to 2/32 inch (1.6 mm) remaining original tread depth (i.e. worn down to the top of the built-in indicators in the original tread grooves) and within 6 years from the date of tire manufacture, any eligible tire that becomes unusable for any reason (see exclusions in the section

entitled “What This Limited Warranty Does Not Cover”) within the manufacturer’s control will either be repaired or replaced at BRIDGESTONE’s option with an equivalent new FIRESTONE brand truck tire on the basis set forth in this Limited Warranty.

### What This Limited Warranty Does Not Cover

This Limited Warranty does not cover the following:

#### ROAD HAZARDS / MISAPPLICATION / ABUSE

Tire damage due to:

- A. **Road hazards**, including, without limitation: puncture, cut, impact break, stone drill, bruise, bulge, snag, etc.
- B. **Improper use or operation**, including, without limitation: improper inflation pressure, overloading, tire / wheel spinning, curbing, use of an improper rim / wheel, tire chain damage, misuse, misapplication, negligence, tire alteration, or for racing or competition purposes.
- C. **Insufficient or improper maintenance**, including, without limitation: wheel misalignment, worn suspension components, improper tire mounting or demounting, tire / wheel assembly imbalance, improper brake adjustment, or other vehicle conditions, defects, or characteristics.
- D. **Contamination or degradation** by petroleum products or other chemicals, fire or other externally generated heat, water or other material trapped inside the tire during mounting or inflation, or inflating tires with anything other than air or nitrogen.
- E. **Improper repair**. Improper repair voids this Limited Warranty.

#### RAPID TREAD WEAR / EXCESSIVE TREAD WEAR:

- A. **Rapid tread wear**, or wear-out is not covered under this warranty.
- B. **No mileage warranty is expressed or implied.**
- C. **Tires rendered unretreadable** due to excessive tread wear or improper buffing.

#### OTHER:

- A. **Uneven or unusual wear** patterns, including, without limitation: Shoulder wear, center wear, cupping, or feathering. Irregular wear is not covered under this warranty.
- B. **Tires worn more than 1/32 inch** (0.8 mm) difference in remaining tread depth between any two major tread grooves across the tire.
- C. **Ride disturbance or vibration** after tread wear use beyond 10% of the original usable tread depth.
- D. **Weather/ozone cracking after 4 years** from date of tire manufacture, regardless of date of purchase.
- E. **Weather/ozone cracking is not** covered under the Enhanced Casing Limited Warranty.

- F. **Tires subjected to severe under-inflation or run-flat conditions.**
- G. **Tires purchased as used.**
- H. **Tires purchased and primarily used** outside the United States.
- I. **Tire improperly retreaded** including, without limitation, improper or inadequate inspection, preparation, equipment, material, repair, etc.
- J. **Tires damaged by the use of internally applied additives** for balance, sealing, cooling or any other alleged tire performance enhancement.
- K. **Improper regrooving.**
- L. **The cost** of applicable federal, state, and local taxes.
- M. **Failure to follow any** of the safety and maintenance recommendations or warnings contained in this manual.

This Limited Warranty is in addition to and / or may be limited by any other applicable written warranty you may have received concerning special tires or situations. Note that additional exclusions, provisions and owner's obligations may be contained in other sections of this manual.

### **No-charge Replacement – New Tire**

Eligible FIRESTONE brand truck tires adjusted under this Limited Warranty will be repaired or replaced at BRIDGESTONE's option free of charge with an equivalent new FIRESTONE brand truck tire (Federal Excise Tax included) up to the first 10% of original usable tread depth or within 12 months from date of purchase (without proof of purchase date, then within 12 months from the date of tire manufacture), whichever occurs first. The cost of mounting and balancing and other service charges, disposal fees, or applicable taxes are payable by you.

### **Pro-rated Replacement – Worn Original Tread Tire**

Eligible FIRESTONE brand truck tires adjusted under this Limited Warranty that are worn beyond the first 10% of original usable tread depth, or 12 months from the date of purchase (without proof of purchase date, then 12 months from the date of tire manufacture) has passed, the tire will, at BRIDGESTONE's option, be repaired or replaced with an equivalent new FIRESTONE brand truck tire on a pro-rata basis. To determine the pro-rated replacement price, the percent of used tread wear is multiplied by the dealer's current selling price for the replacement tire(s). The cost of mounting, balancing, full Federal Excise Tax, and other service charges, disposal fees, or applicable taxes are payable by you. The tire must be less than 6 years from the date of purchase (without proof of purchase date, then 6 years from the date of tire manufacture).

### **Enhanced Casing Credit Limited Warranty**

For coverage under the Enhanced Casing Credit Limited Warranty, the eligible tire must have been used only in long haul, regional, or P&D highway service for the entire life of the casing and subsequent retread(s) must have been inspected and retreaded by an authorized Bandag dealer only. Subject to the terms and conditions stated herein, an Enhanced Casing Credit Limited Warranty is available for the tires described below. An eligible pattern, size and load range tire becomes unserviceable within 6.5 years (78 months) from the date of tire manufacture and is no longer eligible under the Enhanced Casing Credit Limited Warranty.

Eligible tires adjusted under the Enhanced Casing Credit Limited Warranty will receive a casing credit as follows:

- Eligible Patterns: All patterns except those within the "Firestone Classic" line (i.e. FS509, FS 560 Plus, FD609, FD663 and FT409)
- Eligible Sizes & Load Ranges: All

<b>ORIGINAL TREAD OR RETREAD COUNT</b>	<b>DOLLAR VALUES</b> (22.5 and 24.5 rim Diameters)	<b>DOLLAR VALUES</b> (17.5 and 19.5 rim Diameters)
Original Tread*	\$100	\$60
1st Retread	\$80	\$40
2nd Retread	\$50	\$20

\*NOTE: Tires with the original remaining tread depth greater than 2/32 inch (1.6 mm) may receive pro-rated replacement values higher than those in this table.

#### **FIRESTONE CLASSIC:**

- Eligible Patterns: Firestone Classic line (i.e. FS509, FS 560 Plus, FD609, FD663 and FT409)
- Eligible Sizes & Load Ranges: All

<b>ORIGINAL TREAD OR RETREAD COUNT</b>	<b>DOLLAR VALUES</b> (22.5 and 24.5 rim Diameters)	<b>DOLLAR VALUES</b> (17.5 and 19.5 rim Diameters)
Original Tread*	\$90	\$50
1st Retread	\$70	\$30

\*NOTE: Tires with the original remaining tread depth greater than 2/32 inch (1.6 mm) may receive pro-rated replacement values higher than those in this table.

#### **ADDITIONAL EXCLUSIONS FOR THE ENHANCED CASING CREDIT LIMITED WARRANTY**

1. FIRESTONE brand truck tire casings are warranted only when the tire becomes unserviceable due to conditions within the manufacturer's control.
2. The Enhanced Casing Credit Limited Warranty will be valid through the retread period indicated on the appropriate table or 6.5 years from the date of manufacture, whichever comes first.
3. Tires used in severe service, mining and / or logging service are not covered.
4. Casings which cannot be retreaded due to excessive tread wear are not covered.

5. Failures resulting from faulty or incorrect retread processing or materials are not covered.
6. Casing credits are issued according to the appropriate table and will not include the costs of retreading services, materials or other costs.
7. Tires which have the original DOT tire identification numbers removed or rendered illegible are not covered.

### **Replacement Warranty**

If you receive a replacement tire under this Limited Warranty, it will be covered by the manufacturer's warranty, if any, given on that tire at that time.

### **Where To Go**

Tire adjustments under this Limited Warranty will only be made at an authorized FIRESTONE brand truck tire retailer in the United States. Consult a phone directory (often listed in the Yellow Pages under "Tire Dealers"), the Internet at <https://commercial.firestone.com>, or call 1-800-815-9793 for the location nearest you.

### **Consumer Rights**

This Limited Warranty gives you specific legal rights, and you may also have other rights which vary from state to state.

### **Conditions and Exclusions**

To the extent permitted by law, BRIDGESTONE disclaims all other warranties, including but not limited to the implied warranties of merchantability and fitness for a particular purpose and any liability for incidental and consequential damages, loss of time, loss of vehicle use, or inconvenience. Some states do not allow the exclusion or limitation of incidental or consequential damages, so the above limitation or exclusion may not apply to you.

This Limited Warranty applies only to consumers actually purchasing and primarily using the tire in the United States.

Obligations under this policy may not be enlarged or altered by anyone.

In accordance with Federal Law, this Limited Warranty has been designated as a "Limited Warranty." Nothing in this Limited Warranty is intended to be a representation that tire failures cannot occur. This Limited Warranty is given in the United States by Bridgestone Americas Tire Operations, LLC, 200 4th Ave. South, Nashville, TN 37201.

### **Owner's Obligations**

It is your obligation to maintain proper tire inflation pressures as specified by the vehicle manufacturer and to operate the vehicle within tire / vehicle load capacity and speed limitations. It is also your obligation to maintain proper wheel alignment and tire/wheel assembly balance.

To request an adjustment, you must present the tire to an authorized FIRESTONE brand truck tire retailer. Your vehicle on which the tire was equipped must also be available for inspection. Complete and sign the customer section of BRIDGESTONE's Limited Warranty Form or an electronic version of the Bridgestone Limited Warranty Form and pay appropriate replacement price, taxes, disposal fees, and service charges, if any. Tires accepted for warranty compensation become the property of BRIDGESTONE.

### **Arbitration**

You and BRIDGESTONE agree that all claims, disputes, and controversies between you and it, including any of its agents, employees, successors, or assigns, arising out of or in connection with this Limited Warranty, or any other warranties, express or implied, including a failure of warranty and the validity of this arbitration clause, but excluding claims for personal injury or property damage, shall be resolved by binding arbitration between you and it, according to the formal dispute resolution procedures of the National Arbitration Forum, under the Code of Procedure then in effect. This arbitration will be conducted as a document hearing. If you request any procedures beyond a document hearing, you will be responsible for all fees, including filing and administrative fees, above and beyond the fees required for document hearings. The arbitration between you and BRIDGESTONE shall not include any other customers, be combined or consolidated in any fashion with arbitrations involving other customers, or proceed in any form of class action in which the claims of numerous customers are considered together. Any award of the arbitrator(s) may be entered as a judgment in any court of competent jurisdiction. The arbitrators will have no authority to award punitive or other damages not measured by the prevailing party's actual damages, except as may be required by statute. Information may be obtained and claims may be filed at any office of the National Arbitration Forum or at P.O. Box 50191, Minneapolis, MN 55405.

### **Important Safety Information**

Any tire, no matter how well constructed, may fail in use as a result of punctures, impact damage, improper inflation pressure, overloading, or other conditions resulting from use or misuse. Tire failure may create a risk of property damage, serious personal injury or death.

#### **SAFETY WARNING**

Serious personal injury or death may result from a tire failure. Many tire failures are preceded by vibration, bumps, bulges or irregular wear. If a vibration occurs while driving your vehicle or you notice a bump, bulge or irregular wear, have your tires and vehicle evaluated by a qualified tire service professional.

To reduce the risk of tire failure, BRIDGESTONE strongly recommends you read and follow all safety information contained in this manual, tire industry publications such as those published by the U.S. Tire Manufacturers Association (USTMA), and tire mounting procedures published by the Occupational Safety and Health Administration (OSHA) of the U. S. Department of Labor. In addition, we recommend periodic inspection and maintenance, if necessary, by a qualified tire service professional.

## **Tire Inflation Pressure**

Tires need proper inflation pressure to operate effectively and perform as intended. Tires carry the vehicle, passenger, and cargo loads and transmit the braking, acceleration, and turning forces. The vehicle manufacturer recommends the inflation pressures for the tires mounted on your vehicle.

### **SAFETY WARNING**

Driving on tires with improper inflation pressure is dangerous.

- Under-inflation causes excessive tire heat build-up and internal structural damage.
- Over-inflation makes it more likely for tires to be cut, punctured, or broken by sudden impact.

These situations can cause a tire failure, even at a later date, which could lead to serious personal injury or death. Consult the vehicle tire information placard and / or owner's manual for the recommended inflation pressures.

In addition to tire damage, improper inflation pressure may also:

- Adversely affect vehicle ride and handling.
- Reduce tire tread wear.
- Affect fuel economy.

Therefore, follow these important recommendations for tire and vehicle safety, mileage, and economy:

- Always keep the vehicle manufacturer's recommended inflation pressure in all your tires, including inside duals.
- Check their pressure at preventative maintenance intervals and during pre-trip vehicle inspections.

Your vehicle's tire information placard and/or owner's manual will tell you the recommended cold inflation pressure for all your tires. For tractor / trailers, a placard is applied to each. For questions about locating or understanding the tire information placard(s), consult your vehicle owner's manual or ask a qualified tire service professional.

**Maximum Pressure Indicated on the Tire Sidewall:** This is the maximum permissible inflation pressure for the tire only. The vehicle manufacturer's recommended tire pressures may be lower than, or the same as, the maximum pressure indicated on the tire sidewall. The vehicle manufacturer's specification of tire pressure is limited to your particular vehicle and takes into

account your vehicle's load, ride, and handling characteristics, among other criteria. Since there may be several possible vehicle applications for a given tire size, a vehicle manufacturer may choose a different inflation pressure specification for that same size tire on a different vehicle. Therefore, always refer to the inflation pressure specifications on the vehicle tire information placard and/or in your vehicle owner's manual.

**Pressure Loss:** Truck tires can lose 2 psi (14 kPa) per month under normal conditions and can lose 2 psi (14 kPa) for every 10°F (5.6°C) temperature drop. A puncture, leaking valve, or other damage could also cause inflation pressure loss. If a truck tire loses more than 4 psi (28 kPa) per month, have it checked by a qualified tire service professional.

## **Tips For Safe Tire Inflation**

### **SAFETY WARNING**

Inflating an unsecured tire is dangerous. If it bursts, it could be hurled into the air with explosive force resulting in serious personal injury or death. Never adjust the inflation pressure of a truck tire unless it is placed in a safety cage or is secured to the vehicle or a tire mounting machine. Never stand or lean over the tire or in front of the valve when inflating.

### **SAFETY WARNING**

Never re-inflate a truck tire that has been run at very low inflation pressure (i.e. 80% or less of normal operating pressure) without a complete inspection of the entire tire. Immediately have the tire demounted and inspected by a qualified tire service professional.

- The U.S. Department of Transportation requires a pretrip vehicle inspection. Pre-trip vehicle inspections and preventative maintenance should include cold-tire inflation pressure checks. Don't forget to check the inflation pressure of inside duals.
- The only correct method for checking inflation pressure is to use an accurate tire inflation pressure gauge. Kicking or thumping a tire will only tell you when a tire is totally flat.
- Check inflation pressure when the tires are "cold." Tires are considered "cold" when the vehicle has been parked for three hours or more, or if the vehicle has been driven less than a mile at moderate speed.
- Never release pressure from a hot tire in order to reach the recommended cold tire inflation pressure. Normal driving causes tires to run hotter and inflation pressure to increase. If you reduce inflation pressure when your tires are hot, you may dangerously under inflate your tires.
- If it is necessary to adjust inflation pressure when your tires are "hot," set their inflation pressure to 10 psi (69 kPa) above the recommended cold inflation pressure. Recheck the inflation pressure when the tires are cold.

- If your tires lose more than 4 psi (28 kPa) per month, the tire, tube (if applicable), valve, or rim / wheel may be damaged. Consult a qualified tire service professional for an inspection.
- A difference of 5 psi (35 kPa) or more between duals is not recommended.
- Use valve caps to keep the valves clear of debris and to help guard against inflation pressure loss.

### **Tips For Safe Tire Loading**

#### **SAFETY WARNING**

Driving your vehicle in an overloaded condition is dangerous. Overloading causes excessive tire heat build-up and internal structural damage. This can cause a tire failure, even at a later date, which could lead to serious personal injury or death. Consult the vehicle tire information placard, certification label, and owner's manual for the recommended vehicle load limits and loading recommendations.

- Always keep the vehicle manufacturer's recommended inflation pressure in all your tires, including inside duals. Check their pressure at preventative maintenance intervals and during pre-trip vehicle inspections.
- Never exceed the maximum load rating stamped on the sidewall of your tire.
- Never exceed the gross vehicle weight rating (GVWR) or gross axle weight ratings (GAWR) of your vehicle.
- Never exceed the maximum load or inflation pressure capacity of the rim / wheel.
- Consult your vehicle owner's manual for load recommendations and special instructions (such as for carrying unusually heavy loads).

### **Tire Damage and Inspection**

Evaluation and maintenance of your tires is important to their performance and the service they provide to you. Over time and/or through use, the condition of a tire can change from exposure to everyday road conditions, the environment, damaging events such as punctures, and other external factors.

#### **SAFETY WARNING**

Driving on damaged tires is dangerous. A damaged tire can suddenly fail causing serious personal injury or death. Have your tires regularly inspected by a qualified tire service professional.

You should visually inspect your tires during pre-trip vehicle inspections and inflation pressure checks. In addition, have your tires periodically evaluated by a qualified tire service professional when your vehicle is serviced such as routine maintenance intervals, oil changes, and tire rotations. In particular, note the following tips for spotting tire damage:

- After striking anything unusual in the roadway, have a qualified tire service professional demount the tire and inspect it for damage. A tire may not have visible signs of damage on the tire surface. Yet, the tire may suddenly fail without warning, a day, a week, or even months later.
- Inspect your tires for cuts, cracks, splits or bruises in the tread and sidewall areas. Bumps or bulges may indicate a separation within the tire body. Have your tire inspected by a qualified tire service professional. It may be necessary to have it removed from the rim / wheel for a complete inspection. Do not delay performing any necessary repair(s).
- Inspect your tires for adequate tread depth. When the tire is worn to the built-in indicators at 2/32 inch (1.6mm) or less tread groove depth, or the tire cord or fabric is exposed, the tire is dangerously worn and must be replaced immediately. Tires used in the steer position are considered as worn at 4/32 inch (3.2 mm) as noted below.
- Federal regulations require steer axle tires to have 4/32 inch (3.2 mm) or greater tread depth on vehicles over 10,000 lbs (4536 kg) GVWR.
- Inspect your tires for uneven wear. Wear on one side of the tread or flat spots in the tread may indicate a problem with the tire or vehicle. Consult a qualified tire service professional.
- Inspect your rims / wheels also. If you have a bent, chipped, or cracked rim / wheel, it must be replaced.

### **Tire Manufacture Date**

The tire manufacture date is determined by examining the DOT tire identification number, also known as the DOT serial number or code, which can be found on at least one sidewall near the rim / wheel. It may be necessary to look on both sides of the tire to find the entire serial code.

**Tires Produced Since 2000:** The last four (4) digits of the serial code identify the week and year of production. For example, a tire with a serial code ending in "2406" would have been produced in the 24th week of 2006.

**Tires Produced Prior to 2000:** The last three (3) digits of the serial code identify the week and year of production. For example, a tire with a code ending in "329" would likely have been produced in the 32nd week of 1999, but possibly produced in 1989. If in doubt, consult a qualified tire service professional.

## Tire Repairs

### SAFETY WARNING

Driving on an improperly repaired tire is dangerous. An improper repair can be unreliable or permit further damage to the tire. The tire may suddenly fail, causing serious personal injury or death. A complete inspection and repair of your tire in accordance with U.S. Tire Manufacturers Association (USTMA) procedures should be conducted by a qualified tire service professional.

The comprehensive procedures and recommendations for truck tire repair are beyond the scope of this manual; however, note the following:

- **The tire must be demounted from the rim / wheel for a complete inspection, inside and out.** Some damage to the tire may only be evident on the interior of the tire. Any tire repair done without removing the tire from the rim/wheel is improper.
- **A patch must be applied to the interior of the tire and the puncture hole filled with suitable plug / stem filler.** This helps ensure that the interior of the tire is adequately sealed to prevent inflation pressure loss and prevents contamination of the steel belts and other plies from the elements (such as water) in the outside world. Using only a plug / stem, or using only a patch, is not a safe or proper repair.
- **The truck/bus tire puncture repair injury limit to the tread area is 3/8 inch (10 mm).** Larger injuries, or damage in areas outside the tread, should be evaluated and repaired, if possible, by qualified tire service professionals at a full-service repair facility using USTMA-approved procedures.
- **Never substitute a tube for a proper repair or to remedy an improper repair.**
- **Not all punctured or damaged tires can be properly repaired;** consequently, they must be replaced.
- **Repair and retread, if possible, tires having a tread depth of 2/32 inch (1.6 mm) or less remaining in any tread groove.**
- **Tubes, like tires, should only be repaired by a qualified tire service professional.**
- **Any Improper repair voids the tire Limited Warranty.** See "Limited Warranty" in this manual.

## Removing Tire / Wheel Assembly from Vehicle

### SAFETY WARNING

Always follow the manufacturer's recommend procedure for securing and raising your vehicle prior to attempting to remove a tire.

### SAFETY WARNING

If the tire has internal damage, it may burst with explosive force, causing serious personal injury or death. Always deflate a tire and wheel assembly completely before loosening any lug nut when removing a tire from a vehicle for service or demounting. On dual wheel assemblies, both tires should be deflated and removed before any work is started.

## Tire Mounting and Other Servicing

### SAFETY WARNING

Removing and replacing tires on wheels can be dangerous. Attempting to mount tires with improper tools or procedures may result in a tire explosion causing serious personal injury or death. This is only a job for a qualified tire service professional. Never perform tire service procedures without proper training, tools, and equipment.

**This manual is not intended to provide proper training or service procedures for tire mounting, demounting, balancing, rotation, or repair. Please leave these tasks to qualified tire service professionals.**

Only specially trained persons should mount tires. For proper mounting procedures, consult the requirements of the Occupational Safety and Health Administration (OSHA) of the U S Department of Labor and procedures published by the U.S. Tire Manufacturers Association, 1400 K Street, NW Washington, D. C. 20005 ([www.ustires.org](http://www.ustires.org)).

### SAFETY WARNING

Inflating an unsecured tire is dangerous. If it bursts, it could be hurled into the air with explosive force resulting in serious personal injury or death.

- Always stand well clear of any tire mounting operation. This is especially important when the service operator inflates the tire.
- When inflating a tire after mounting on a rim / wheel, always use a safety cage and an extension hose with pressure gauge and clip-on chuck.
- Never adjust the inflation pressure of a truck tire unless it is placed in a safety cage or is secured to the vehicle or a tire mounting machine.
- Never stand or lean over the tire or in front of the valve when inflating.

### SAFETY WARNING

Never pour or spray any flammable substance into or onto a tire or rim/wheel for any purpose whatsoever. The residue left by the substance could result in a fire or explosion which may cause severe injury or death.



**SAFETY WARNING**

Never put flammable substances such as gasoline or ethyl ether into a tire and light with a match / flame so that the resulting explosion seats the beads of a tubeless tire. This practice is extremely dangerous and may result in a severe explosion or undetected damage to the tire or rim/wheel which may cause a failure resulting in severe injury or death.

- **Tires must match the width and diameter requirements of the wheels.** For example, 22.5 inch diameter tires must only be mounted to 22.5 inch diameter rims / wheels. Radial tires must only be mounted to wheels approved for radial tires.
- **Inspect the tire and rim / wheel.** Rims / wheels must be free of cracks, dents, chips, and rust. Tires must be free of bead damage, cuts, punctures, foreign material, and moisture.
- **For a tubeless truck tire, always install a new valve, or new valve core and cap,** each time a new or retreaded tire is installed.
- **For a tube-type truck tire, always use a new, proper size tube and flap** each time a new or re-treaded tire is installed.
- **Use only vegetable oil-based lubricants in mounting or demounting.**
- **Always ensure rim components fit properly before inflating.**
  - Never tap component parts with a tool / hammer / mallet while tire is inflated.
  - Never attempt to disassemble multi-piece rims while inflated.
- **Never inflate a tire beyond 40 psi (275 kPa) to seat the beads.** Be absolutely certain beads are fully seated before adjusting inflation pressure to the level recommended for vehicle operation.
- **Use valve caps** to keep the valves clear of debris and to help guard against inflation pressure loss.
- **Always stand well away from the work area** when tires are being spin-balanced either on or off the vehicle.

**Tire Mixing****SAFETY WARNING**

Driving your vehicle with an improper mix of tires is dangerous. Your vehicle's handling characteristics can be seriously affected. You could have an accident resulting in serious personal injury or death. Consult your vehicle owner's manual and a qualified tire service professional for proper tire replacement.

**Dual Matching**

Tires paired in a dual assembly should be matched in tire construction and dimension. Improperly matched tires may result in irregular wear, rapid wear, and premature tire failure. Failure to match tires in a dual assembly may result in sudden tire destruction.

For radial tires, properly paired dimension tolerances are as follows:

- Diameter: within 1/4 inch (6.4 mm) of each other
- Circumference: within 3/4 inch (19 mm) of each other

**High Speed Driving****SAFETY WARNING**

Driving at high speed is dangerous and can cause a vehicle accident, including serious personal injury or death.

- Regardless of the speed and handling capabilities of your vehicle and its tires, a loss of vehicle control can result from exceeding the maximum speed allowed by law or warranted by traffic, weather, vehicle, or road conditions.
- High-speed driving should be left to trained professionals operating under controlled conditions.
- No tire, regardless of its design or speed rating, has unlimited capacity for speed, and a sudden tire failure can occur if its limits are exceeded. See "Tire Speed Restrictions," the next section in this manual.

**Refer to your vehicle owner's manual for any tire pressure recommendations for high speed driving.**

**Tire Speed Restrictions**

Firestone brand truck tires have maximum recommended speeds. When replacing your tires, check your vehicle owner's manual and tire information placard and consult with a Firestone brand truck tire retailer for recommendations and information about tire speed capability.

The speed capabilities of truck tires are based on standardized laboratory tests under specific, controlled conditions. While these tests may relate to performance on the road, real-world driving is rarely identical to any test conditions. Your tire's actual speed capability may be less since it is affected by factors such as inflation pressure, load, tire condition (including damage), wear, vehicle condition (including alignment), driving conditions, and duration at which the speed is sustained.

## **Tire Spinning**

### **SAFETY WARNING**

Spinning a tire to remove a vehicle stuck in mud, ice, snow, or wet grass can be dangerous. A tire spinning at a speedometer reading above 35 mph (55 km/h) can in a matter of seconds reach a speed capable of disintegrating a tire with explosive force. Under some conditions, a tire may be spinning at a speed twice that shown on the speedometer. This could cause serious personal injury or death to a bystander or passenger. Never spin a tire above a speedometer reading of 35 mph (55 km/h).

## **Tire Storage**

Tires should be stored indoors in a cool, dry place where water cannot collect inside them. Tires should be placed away from electric generators / motors and sources of heat such as hot pipes. Storage surfaces should be clean and free of grease, gasoline, diesel fuel, or other substances which can deteriorate the rubber.

### **SAFETY WARNING**

Improper storage can damage your tires in ways that may not be visible and can lead to a failure resulting in serious personal injury or death.

The spare tire in your vehicle is intended to be used as a spare when needed. The spare tire carrier is not intended to be used for long term storage.

## **Tire Service Customer Satisfaction**

Normal tire maintenance and Limited Warranty services are available at locations across the U.S.A. Visit us at <https://commercial.firestone.com>, or call **1-800-815-9793** to find an authorized Bridgestone brand truck tire retailer nearest you.

Additional information on the care and service of truck tires is available from the following organizations:

### **U.S. Tire Manufacturers Association**

1400 K Street, N.W.  
Washington, DC 20005-2403  
[www.ustires.org](http://www.ustires.org)

### **Tire and Rubber Association of Canada**

A19-260 Holiday Inn Drive  
Cambridge, ON, N3C 4E8  
[www.tracanada.ca](http://www.tracanada.ca)

## **Tire Registration**

Registration of your tires is an important safety precaution since it enables the manufacturer to notify you in the event of a recall. When you purchase replacement tires, the retailer will provide a registration card on which the tire identification numbers have been recorded; fill in your name and address on the card and mail it promptly. Some retailers may submit the registration for you. You do not need to register original equipment tires on new vehicles as the vehicle manufacturer handles that for you.

## **For Assistance or Information**

1. First contact the nearest Firestone truck tire dealer by consulting the yellow pages of your local telephone book.
2. If additional assistance is required, call or write the nearest Bridgestone Technical Service Center listed below.

## **Bridgestone Toll Free Number**

**1-800-847-3272**

### **Bridgestone Americas Tire Operations, LLC**

200 4th Ave. South  
Nashville, TN 37201

## Commercial Tire Tubes, Valves & Flaps

TIRE SIZE	TUBE	VALVE	FLAP
8.25R15	8.25R15	TR444	15R7
9.00R15	9.00R15	TR444	15R8
10.00R15	10.00R15	TR444	15R8
8.25R20	8.25R20	TR442	20R7
9.00R20	9.00R20	TR444	20R8
10.00R20	11.1/10.00R20	TR444	20R8
11.00R20	11.00R20	TR444	20R8

TIRE SIZE	TUBE	VALVE	FLAP
12.00R20	12.00R20	TR444	20R9
13/80R20	13/80R20	VS3-04-06	20R9
14/80R20	14/80R20	VS3-04-06	20R10
10.00R22	10.00R22	TR444	22R8
11.00R22	11.00R22	TR444	22R8
11.00R24	11.00/12.00R24	TR444	24R8
12.00R24	11.00/12.00R24	TR444	24R9

## Radial & Bias Tire Construction



**Radial**

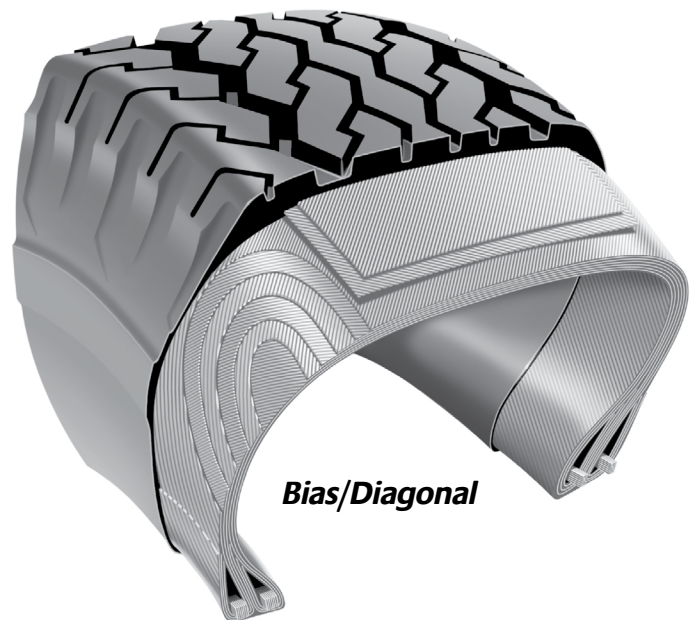

**Bias/Diagonal**

Radial tire body ply cords are placed straight across the tire from bead to bead. In addition, radial tires have belt plies, which run circumferentially around the tires, under the tread. They constrict the radial ply cords and stabilize the tread area.

Bias/Diagonal tires have multiple layers of plies with the cords in adjacent plies running in alternate diagonal directions from bead to bead. The tires may also have narrow plies under the tread, called breakers, with cords that lie in approximately the same direction as the body ply cords.

The type of construction can be determined by looking at the size designation molded on the tire's sidewall. Radial truck tire sizes have an "R" in the size designation while bias/diagonal truck tire sizes have a hyphen in the size description. For example, a 10.00R20 tire is a radial, while a 10.00-20 tire is a non-radial.

In addition, ALL radial tires have the word "RADIAL" molded onto the sidewall. All radial truck tires also use an "R" in the size designation, e.g., 285/75R24.5.

## Definitions

### Truck Tire Size Designation

**10.00 R 20 14 (G)**

Nominal Section Width in Inches (Conventional)

Radial Construction

Tube Type Rim Diameter in Inches (5° Tapered Bead)

Ply Rating

Load Range

**11 R 22.5 14 (G)**

Nominal Section Width in Inches (Conventional)

Radial Construction

Tubeless Rim Diameter in Inches (15° Tapered Bead)

Ply Rating

Load Range

Nominal Section Width  
in Millimeters (Metric)

**A 285/75 R 24.5 14 (G)**

Aspect Ratio

Radial Construction

Tubeless Rim Diameter in Inches (15° Tapered Bead)

Ply Rating

Load Range

see page 51

see page 54

see page 54

Nominal Section Width  
in Millimeters (Metric)

**315/80 R 22.5 20 (L)**

Aspect Ratio

Radial Construction

Tubeless Rim Diameter in Inches (15° Tapered Bead)

Ply Rating

Load Range

Nominal Section Width  
in Millimeters (Metric)

**445/50 R 22.5 20 (L)**

Aspect Ratio

Radial Construction

Tubeless Rim Diameter in Inches (15° Tapered Bead)

Ply Rating

Load Range

# Truck Tire Dimensions

## A. (Nominal) Section Width

Measurement of the cross section of an unladen tire across the casing only – not including ribs or protrusions.

## A. Overall Width

Measurement of the cross section of an unladen tire, including ribs and protrusions. Usually the same as section width on radial tires.

## B. Section Height

Distance from the bead seat to the tread surface of an unladen tire.

## C. Aspect Ratio

$$\text{Aspect Ratio} = \frac{\text{Section Height}}{\text{Section Width}}$$

## D. Tread Width

Distance across the tread face of an unladen tire.

## E. Tread Depth

Distance from tread surface to major groove base at designated measuring point.

## F. Loaded Width

The maximum section width of a loaded tire under maximum dual load and inflation as stamped on the sidewall of the tire.

## G. Overall Diameter

The measurement of the distance of an unladen tire from tread surface to tread surface on opposite sides of the tire.

## H. Static Loaded Radius

Distance from the center of the axle to the ground of a loaded tire under maximum dual load and inflation as stamped on the sidewall of the tire.

## I. Rim Width

Distance between the rim flanges.

## J. Nominal Rim Diameter

Diameter of the rim from bead seat to bead seat in inches.

## Minimum Dual Spacing

The minimum allowable distance between the wheel center lines in a dual arrangement.

## Revolutions Per Mile (RPM)

The number of tire revolutions in one mile, measured at 55 mph maximum dual load and inflation (as stamped on the tire's sidewall).

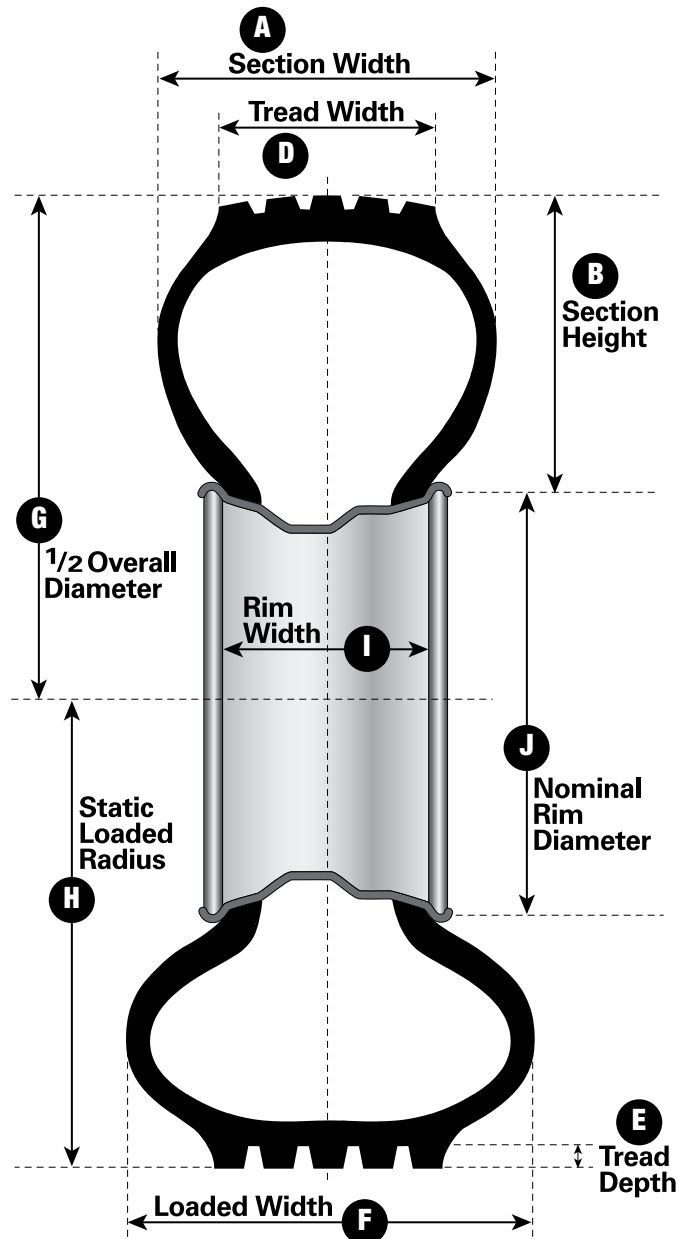

**NOTE: Tires mounted and inflated to recommended pressure. All dimensions measured 24-hours after initial inflation.**

## Ply Rating/Load Range

PLY RATING	LOAD RANGE
2	A
4	B
6	C
8	D
10	E
12	F
14	G
16	H
18	J
20	L

While there is no industry-wide definition of ply rating, truck tires are frequently marked with ply rating and equivalent load range. These markings are used to identify the load and inflation limits of that particular tire, when used in a specific type of service. See adjacent table for conversion of tire markings. Corresponding loads may be found in appropriate load tables.

## Speed Symbol

SPEED SYMBOL	SPEED CATEGORY (KM/H)	MPH
F	80	50
G	90	55
J	100	62
K	110	68
L	120	75
M	130	81
N	140	87

The SPEED SYMBOL indicates the speed at which the tire can carry a load corresponding to its Load Index under service conditions specified by the tire manufacturer.

## International Load Index Numbers

LOAD INDEX	KGS	LBS	LOAD INDEX	KGS	LBS	LOAD INDEX	KGS	LBS	LOAD INDEX	KGS	LBS	LOAD INDEX	KGS	LBS	LOAD INDEX	KGS	LBS
90	600	1325	104	900	1985	118	1320	2910	132	2000	4410	146	3000	6610	160	4500	9920
91	615	1355	105	925	2040	119	1360	3000	133	2060	4540	147	3075	6780	161	4625	10200
92	630	1390	106	950	2095	120	1400	3085	134	2120	4675	148	3150	6940	162	4750	10500
93	650	1435	107	975	2150	121	1450	3195	135	2180	4805	149	3250	7160	163	4875	10700
94	670	1475	108	1000	2205	122	1500	3305	136	2240	4940	150	3350	7390	164	5000	11000
95	690	1520	109	1030	2270	123	1550	3415	137	2300	5070	151	3450	7610	165	5150	11400
96	710	1565	110	1060	2335	124	1600	3525	138	2360	5205	152	3550	7830	166	5300	11700
97	730	1610	111	1090	2405	125	1650	3640	139	2430	5355	153	3650	8050	167	5450	12000
98	750	1655	112	1120	2470	126	1700	3750	140	2500	5510	154	3750	8270	168	5600	12300
99	775	1710	113	1150	2535	127	1750	3860	141	2575	5675	155	3875	8540	169	5800	12800
100	800	1765	114	1180	2600	128	1800	3970	142	2650	5840	156	4000	8820	170	6000	13200
101	825	1820	115	1215	2680	129	1850	4080	143	2725	6005	157	4125	9090			
102	850	1875	116	1250	2755	130	1900	4190	144	2800	6175	158	4250	9370			
103	875	1930	117	1285	2835	131	1950	4300	145	2900	6395	159	4375	9650			

Selection of Load Index Numbers: Select the load index number with the equivalent load of the tire (round up to midpoint). If the tire maximum load rating is only given in customary units, convert that load to kilograms and select the closest load index equivalent (Kg) load.

# Inflation Pressure

For optimum tire performance, proper inflation pressures for the loads being carried must be maintained. The proper inflation pressure can be found in the load and inflation tables of this book.

Air pressure of all tires should be checked and corrected weekly with an accurate inflation pressure gauge. Since air expands when heated, tire pressures will increase due to the normal build-up of heat during operation. For this reason, tire pressures should be checked while cold. Do not bleed air from tires while hot. This will result in an under-inflated condition.

Under-inflated tires build up excessive heat due to over-deflection and may result in tire deterioration. Operating on an improperly inflated tire will cause severe tire damage.

The inflation pressures given are the minimum pressures for the associated load. Do not exceed the maximum loads listed in this book without consulting a Bridgestone Technical Representative. Any tire known or suspected to have been run at 80% or less of normal operating inflation pressure and/or overloading could possibly have permanent structural damage (steel cord fatigue).

# Tire Mixing

Tires of different sizes or construction must never be mixed on the same axle.

Tires of different construction can be mixed in the following manner:

**A) TRUCKS WITH TWO AXLES, FOUR WHEELS:**

Radials can be mixed with bias ply tires providing the radials are mounted in pairs on the rear axle.

**B) TRUCKS WITH TWO AXLES, SIX WHEELS:**

(e.g. single axle tractors) Radials can be mixed with bias ply tires providing tires of the same construction are mounted on the same axle.

**C) TRUCKS WITH MORE THAN TWO AXLES:**

(e.g., tandem axle tractors) The front tires may be bias or radial and can be run with bias or radial on the drive axles. Trucks with multiple drive axles

should have tires of the same construction mounted on all drive positions.

**D) TRAILERS:**

Bias or radial tires may be used, providing tires on the same axle are of the same construction. Tires of different construction must not be used in dual fitments. Tubeless tires can be mixed with tube-type tires, providing they are of equivalent sizes.

**E) WIDE BASE & DUALS:**

Wide base and duals can be mounted together as long as overall diameter is within 1/4 inch.

# Dual Matching

Tires in dual assemblies should be matched with regard to design and dimensional tolerances as noted below.

Improperly matched duals may result in irregular wear, rapid wear, vehicle mechanical problems and premature tire failure. Failure to match tires in a dual assembly may result in sudden tire destruction.

## DUAL MATCHING LIMITS

TIRE CONSTRUCTION	DIAMETER	CIRCUMFERENCE
Radial	0 to 1/4 inch	0 to 3/4 inch

# Mismatched Duals

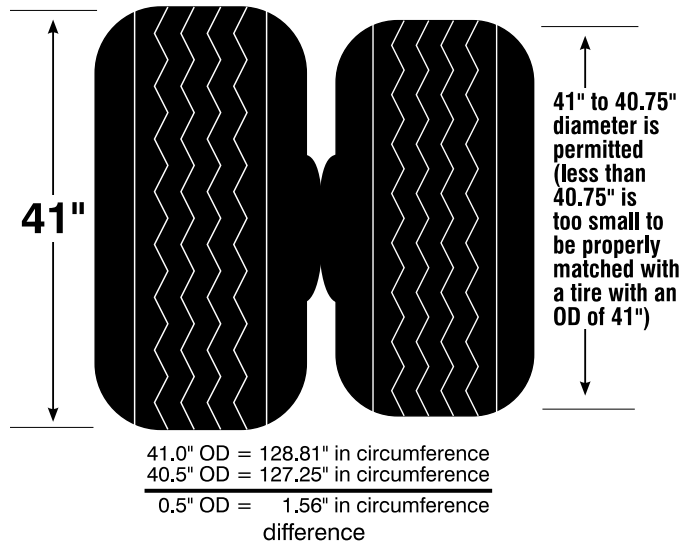

## Medium Truck Approved Rim Width & Minimum Dual Spacing

TIRE SIZE	APPROVED RIM WIDTH	MIN. DUAL SPACING
<b>TUBE TYPE</b>		
11.00R24	8.5, 8.50VM, <b>8.0</b> , 7.5	13.2
12.00R24	9.0, <b>8.5</b> , 8.50VM, 8.0	14.1
<b>TUBELESS</b>		
9R17.5HC	<b>6.75HC</b>	10.3
8R19.5	5.25, <b>6.00</b> , 6.00RW, 6.75, 6.75RW	9.1
9R22.5	6.00, <b>6.75</b> , 7.50	10.3
10R22.5	6.75, <b>7.50</b> , 8.25	11.4
11R22.5	7.50, <b>8.25</b>	12.5
12R22.5	8.25, <b>9.00</b>	13.5
11R24.5	7.50, <b>8.25</b>	12.5
12R24.5	8.25, <b>9.00</b>	13.5
215/75R17.5	<b>6.00HC</b> , 6.75HC	9.3
245/70R17.5	<b>6.75</b> , 7.50	10.6
225/70R19.5	6.00, 6.00RW, <b>6.75</b> , 6.75RW	10.0
245/70R19.5	6.75, 6.75RW, <b>7.50</b> , 7.50RW	11.0
265/70R19.5	6.75, <b>7.50</b> , 7.50RW, 8.25, 8.25RW	11.6
285/70R19.5	7.50, <b>8.25</b> , 9.00	12.5
305/70R19.5	<b>9.00</b> , 8.25, 8.25RW	13.5
445/65R19.5	<b>13.00</b> , 14.00	NA
245/75R22.5	6.75, <b>7.50</b>	11.0
255/70R22.5	<b>7.50</b> , 8.25	11.3
265/75R22.5	<b>7.50</b> , 8.25	11.6
275/70R22.5	7.50, <b>8.25</b> , 9.00	12.2
295/60R22.5	<b>9.00</b> , 9.75	13.0
295/75R22.5	8.25, <b>9.00</b>	13.2
295/80R22.5	8.25, <b>9.00</b>	13.2
305/70R22.5	8.25, <b>9.00</b>	13.5
315/80R22.5 †	8.25, <b>9.00</b> , 9.75	13.8
385/65R22.5	<b>11.75</b> , 12.25	NA
425/65R22.5	11.75*, <b>12.25</b> , 13.00, 14.00	NA
445/50R22.5	<b>14.00</b>	NA
445/65R22.5	12.25*, <b>13.00</b> , 14.00	NA
455/55R22.5	<b>14.00</b>	NA
285/75R24.5	<b>8.25</b>	12.5

**Minimum Dual Spacing** is listed for the design rim width. If design rim not used Minimum Dual Spacing must be adjusted per note 1 (below) for other rim widths.

**Design Rim Width** shown in boldface type.

† 8.25-rim may be used if tire load is limited to 8,000 lbs. single and 7,610 lbs. dual @ 120 psi. Note: The minimum dual spacing for 8.25-rim is 13.2". Do not exceed manufacturer's recommended maximum load and inflation. *Contact tire manufacturer for confirmation of acceptability of dual spacing.*

Note 1: New tire section widths and overall widths will change 0.10-inches for each 0.25-inch change in rim width.

Note 2: Use alternate rims only when recommended rims cannot be used.

Note 3: Do not use different rim widths in dual applications.

\* This rim size maybe phased out in the future for this tire size.



## Tire Rotation

Tire rotation is a practical means of reducing tire costs when irregular or rapid wear are prevalent. Rotation patterns, such as those recommended by vehicle manufacturers, may be followed. There are no restrictions on criss-cross rotation. Tires having directional type tread patterns should be mounted in the recommended direction of rotation for optimum performance.

For many directional type designs it is permissible to change the direction of rotation after the first  $3/32''$  -  $5/32''$  of tread wear. Contact tire manufacturer for pattern-specific recommendation. The casing, after retreading, may be run in either direction, as the casing is not directional.

## Regrooving

Regroove only those tires marked "Regroovable" on the sidewall. Tires with a remaining tread depth of less than  $2/32''$  should not be regrooved. It is recommended that tires exhibiting severe irregular wear not be regrooved. Regrooved tires should not be placed on the front axle.

Regrooving should be restricted to the tire's original tread grooves. A minimum rubber gauge of  $4/32''$  must be maintained between the tire's top belt and the re-grooved grooves.

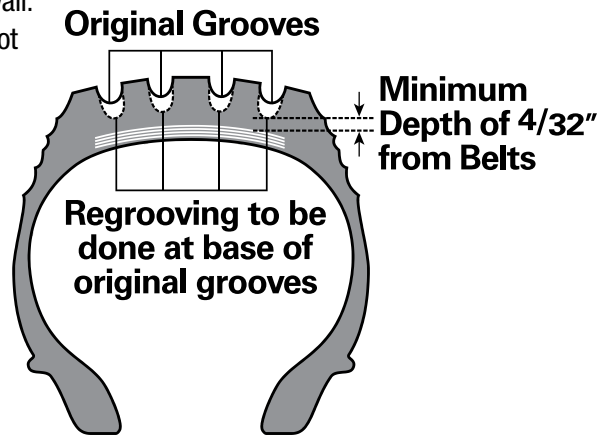

## Branding

The location for branding must be chosen carefully due to the thin sidewall gauge. Many sidewalls have branding panels, or designated branding areas as noted in sketch at left. Branding in the wrong location may result in eventual tire failure. It is recommended that the brand be located between the rim line and size panel.

Branding depth should be  $1/32''$ . Do not brand deeper than  $2/32''$ .

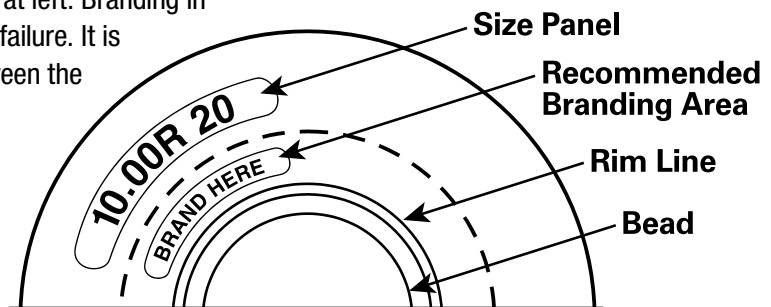

*Proper Branding Area on Steel Radial Tire*

# Wheel Alignment

## Toe-In

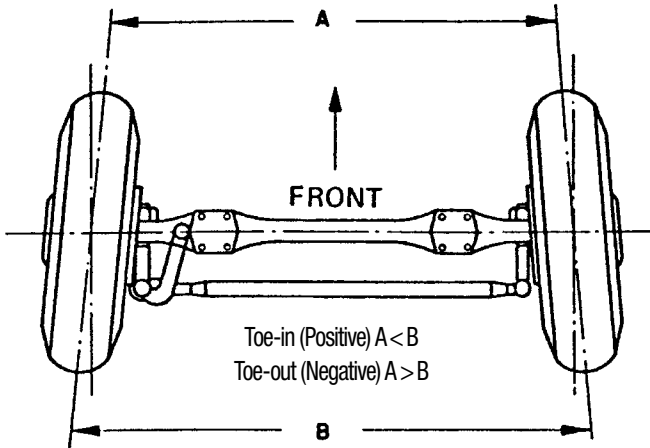

Proper wheel alignment is essential for optimum tire life and vehicle handling characteristics. **Alignment settings should be checked with the truck loaded.** Alignment adjustments can be made on an unloaded truck; however, modifications in the vehicle manufacturer's alignment recommendations may be required for proper "loaded" settings.

### Front Axle Recommendations

- **Toe-in:** set as close to zero as vehicle manufacturer's recommendations allow in loaded condition. Do not set beyond zero, as a toe-out condition will develop.
- **Caster:** set to the maximum positive setting which the vehicle manufacturer's recommendations will allow.
- **Camber:** set as close to zero degrees as the vehicle manufacturer's recommendations allow in loaded condition.

## Caster

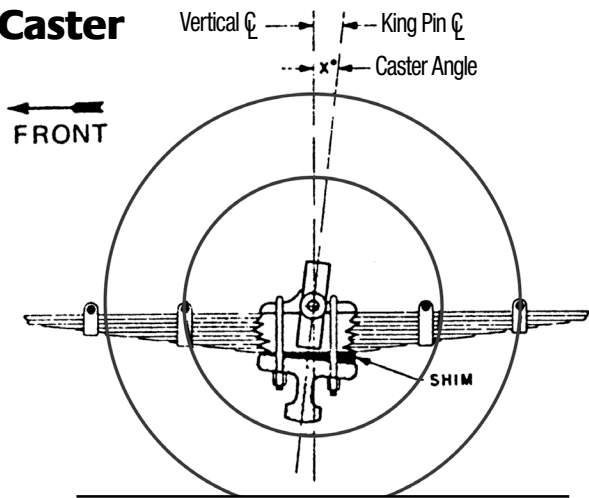

### Drive Axle Recommendations

Misalignment of the drive axles may also cause rapid or irregular wear on the front axle as well as the drive axle due to constant steering correction. Drive axle alignment should be corrected before front axle settings are made.

Drive axles should be aligned in the following manner:

1. Position drive axles perpendicular to the chassis centerline.
2. For tandem drives, the drive axles should be positioned parallel to one another.

## Camber

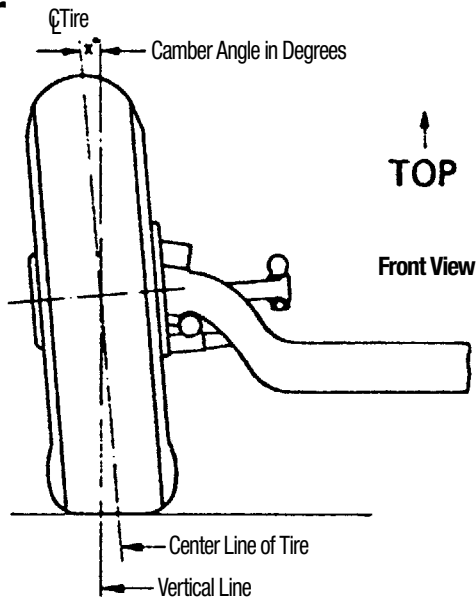

If they are not parallel, the condition is referred to as "tandem scrub." Our recommendation is the distance between the axle centers is set so the distance on the right is equal to or greater than the distance on the left by up to 1/8" (.125").

The distance on the axle centers on the right should never be shorter than the distance on the left. The wear pattern that will result from this situation is inside left front/outside right front shoulder wear.

# Balance/Runout

Tire and wheel imbalance may result in irregular tire wear. Steering axle and drive axle tires should be balanced dynamically for best results. Vibration may also be the result of mismatch of the high and low spots of the tire and wheel.

To resolve vibration problems, the runout of tire and rim should be measured, then matched in the following manner:

1. With the tire mounted on the rim, number both at 12 asymmetrical points.
2. Measure runout at both shoulders of the tire (inside & outside) and record the results. (Note: accuracy in these measurements is essential.)
3. Demount the tire, measure both sides of the rim for runout, record the results, then average the inside and outside measurements.
4. Matching the lowest average point of the rim to the highest average point of the tire, remount the tire, then balance accurately.
5. It may be necessary to repeat this procedure since the tire cannot be measured accurately while on an imperfect rim.

Note: If a runout dial is not available, rotate the tire 180° relative to the rim and remount. If the vibration persists, rotate the tire another 90°, then another 180°.

6. The maximum suggested radial runout for a rotating tire/wheel assembly is 0.095 inches for both front and rear tire positions. If runout exceeds these limits, check for bent rims, cocked rims, improperly adjusted wheel bearings, improper tire bead seating, tire flat spots, improperly tightened rim clamps and rear rim spacers.

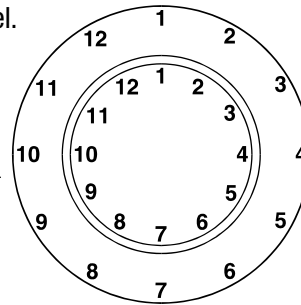

**Proper Position for Measuring Runout**

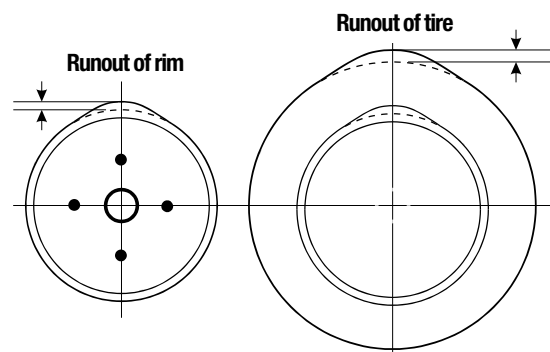
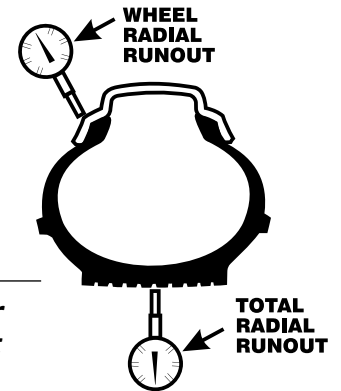

**Runout of Tire Due to Runout of Rim**

## Special procedure for improving steering tire run-out on vehicles with hub-piloted wheels

If you suspect high run-out on the steering position and have hub-piloted wheels, use the following procedure to improve the radial run-out.

1. Measure the radial run-out of the tire/wheel assemblies on the vehicle's steering position. Mark the highest and lowest points of the radial run-out on the tire with chalk or other marker.
2. Remove the tire/wheel assembly and position the hub so that the gap between any two of the hub pilot pads is at 12:00. With the hub in this position place the tire/wheel assembly on the hub so that the high point mark is at the top (12:00). Carefully tighten one nut with a hand wrench until it is snug enough to hold the wheel securely. Reposition the wheel on the hub pilot pads while tightening.

(Don't use an air wrench to tighten the first nut. It will reposition the wheel and not let gravity keep the wheel in contact with the hub pads that are at the top). After the first nut is tightened with the hand wrench, tighten all nuts according to sequence and procedure shown in **TMC RP 222, User's Guide to Wheels and Rims**.

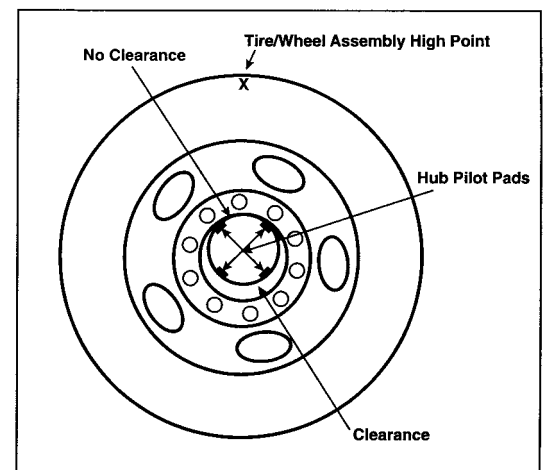

Figure 7

continues >>

If you have followed this procedure correctly, you will find there is clearance between the hub pads and the wheel pilot hole at the bottom and no clearance at the top (See Figure 7.) shown on previous page.

3. Recheck the radial runout to verify that it has been improved. By locating the high point, repositioning the wheel, putting the high point at the top and re-tightening, gravity should have put the wheel in a better position with

respect to the hub. Improvements up to .020" are common and can greatly improve the ride.

[ Information reprinted with permission from: **RP 214E, Tire/Wheel Balance and Runout**, in **TMC's Recommended Practices Manual**, published by the Technology & Maintenance Council (TMC) of American Trucking Associations, 2200 Mill Road, Alexandria, VA 22314; (703) 838-1763. [tmc.truckline.com](http://tmc.truckline.com) ]

## Tire Mounting For Low Vibration

### Special Low Vibration Mounting For Bridgestone Radial Truck Tires

All Bridgestone tires have yellow marks, to aid in initial balance. (White marks are factory inspection marks, and are not used in mounting or balancing).

Proper use of these marks during new tire mounting and installation can result in a better ride and less vehicle vibration.

Place the yellow mark next to the valve stem, regardless of wheel type. Torque wheel nuts with the yellow mark at the "12 o'clock" position.

On dual assemblies, regardless of tire marks, install tires on axles with valve stems approximately 180 degrees apart.

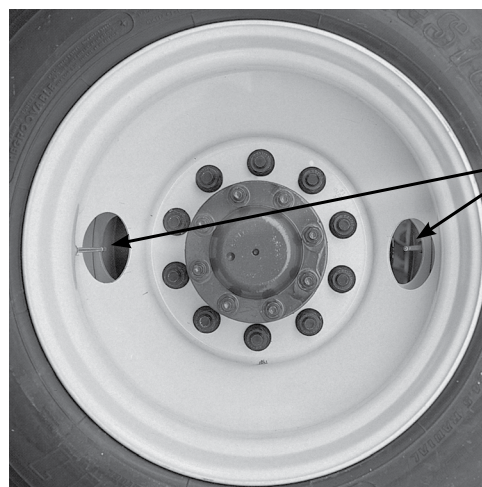
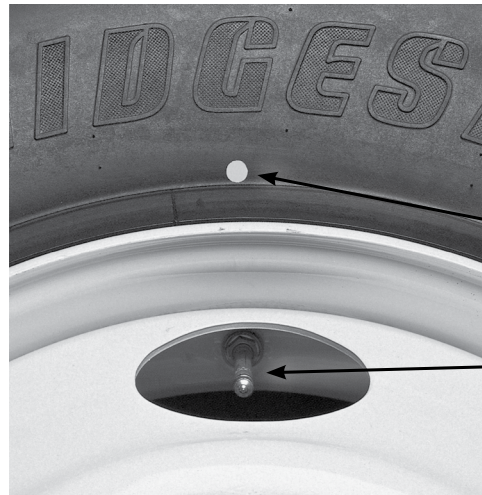

## Mounting Radial Truck Tires to Help Reduce Vibration & Irregular Wear

Consistent, correct truck tire mounting is important for proper bead-to-wheel fit, and can help reduce vehicle vibration and irregular wear for better ride and longer original tread life.

Important steps:

1. Clean and paint used wheels.
2. Lubricate both tire beads and both wheel seats.
3. Check the assembly for even centering.

**Always follow all OSHA, RMA and manufacturer's tire mounting safety precautions!**

*(See Section on Mounting/Demounting Procedures in this data book.)*



1. Remove dirt, rust or corrosion that can interfere with proper seal or damage bead.



5. Inflate assembly to set bead and check for leaks around the wheel.



2. Protect bare metal with primer or anti-rust paint to prevent further corrosion. Allow to dry.

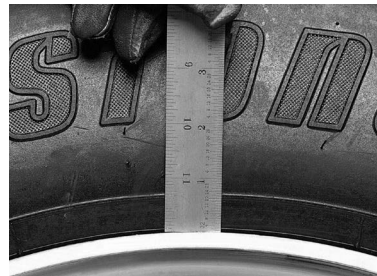

6. Measure distance from molded ring on tire to flange locations, 90 degrees apart.



3. Lubricate the wheel bead seat using vegetable oil-based lubricant approved for both tire and wheel.

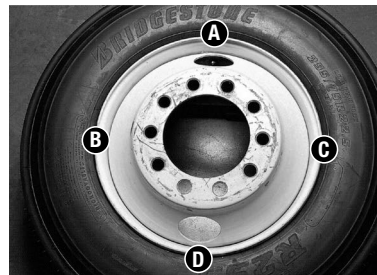

7. Distances A, B, C, and D should be within  $2/32$ ". If they are not, break down, re-lubricate and mount again.



4. Lubricate tire bead. Do not use petroleum or solvent-based products. They cause rubber to deteriorate.

## Storage

All tires should be stored in accordance with the following recommendations:

1. Avoid storing tires in direct sunlight.
2. Avoid storing tires near a heat source or in the path of a direct flow of forced air.
3. Keep tires away from electric motors and generators which produce ozone.
4. Do not store near petroleum products or chemicals (such as oil, grease, gasoline, solvent, etc.).
5. Limit vertical stacking to a maximum of 5 feet in height.
6. Store un-mounted tires indoors in a dry location. Steel radial tires may be severely damaged due to the

presence of moisture inside the tire at mounting. Upon pressurization, this moisture can permeate the casing of the tire and cause severe deterioration of the steel cords.

7. Prior to mounting, inspect the inside surfaces of the tire and remove all foreign material and moisture.
8. Keep compressed air sources for tire inflation free of moisture.

**Failure to follow the above recommendations could result in sudden tire failure, property damage and personal injury.**

## Tire Inspection

Prior to operating a vehicle, an inspection should be made of each tire, including the spare. Examine tires for cuts, bruises, cracks, bulges and penetrations. If any damage is found, have the tire examined by a Bridgestone dealer. Repair of tire damage must be made as soon as possible in order to avoid further deterioration of the tire structure.

Federal law requires that front axle truck tires on vehicles over 10,000 lbs. gross vehicle weight must have at least 4/32" tread depth. Tread wear indicators are contained in the tread of Bridgestone truck tires and become visible when the tread depth reaches 2/32" in two adjacent major grooves.

Drive and trailer tires should be replaced when the tread depth reaches 2/32" or the wear bars appear since 2/32" is the minimum permissible legal tread depth on all axles except the front.

Tires should also be inspected prior to mounting on a rim. Bridgestone steel radial tube-type truck tires are shipped with the flap in the tire. It is essential that the tire be disassembled and inspected thoroughly prior to mounting to insure the inside surfaces are completely dry and clean.

Water in casings of steel radial tires may cause tire failure. During normal operation, heat build-up inside the tire will turn water into vapor which may permeate the inner-liner and enter the steel casing cord, causing rust, deterioration, possible sudden tire failure, property damage and/or personal injury.

	DOT Legal Limits
Steering Axle	4/32"
Drive Axle	2/32"
Trailer Axle	2/32"

## Irregular Wear of Radial Truck Tire

There are many factors that may trigger the occurrence of irregular wear. Among those, mechanical malfunctions of vehicles such as misalignment and uniformity of the tire and wheel assembly are the major factors. If, after correction of these problems is made, objectionable irregular wear is still observed, Bridgestone recommends the following steps be taken:

**Steer-axle tires:** Check thrust angle & apply higher inflation pressure within permissible range (100–115 psi).

**Drive-axle tires:** An increase of 10-15 psi makes the tire less susceptible to irregular wear. Forward movement of the fifth wheel within permissible range greatly reduces irregular wear.

## Low Profile Tires

Low profile 75-series tubeless truck radial tires may offer several advantages over standard 90-series tubeless tires, such as:

1. Increased tread life
2. Positive handling
3. Lower vehicle height
4. Lighter weight

Care must be taken when converting to lower profile tires. Differences in overall diameter, static loaded radius and maximum load carrying capacity should be considered prior to mounting lower profile tires.

### CONVERSION TO LOW PROFILE TIRES

#### Change In Overall Diameter

(FD663 Example)

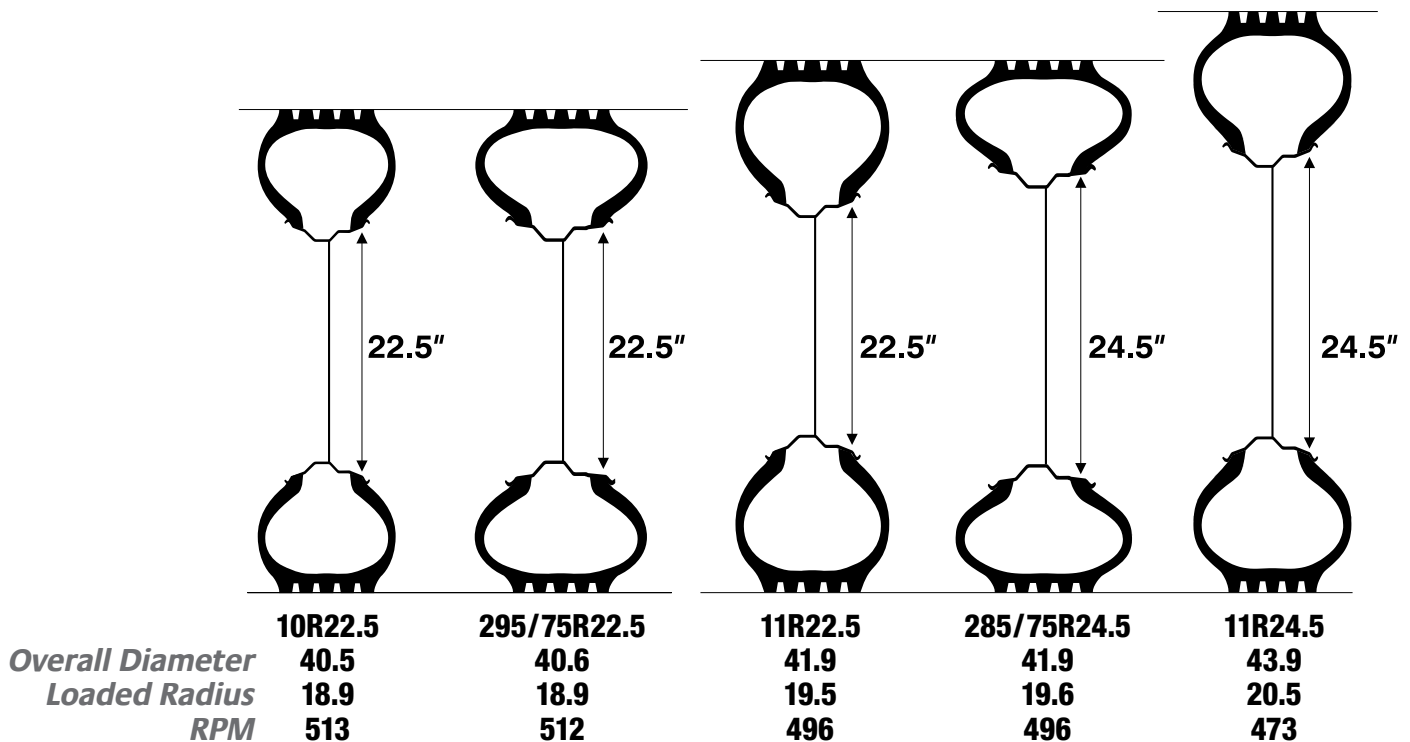

# Mounting/Demounting Procedures

Proper mounting procedures must be followed or sudden tire destruction, personal injury or death may result. Tire mounting must be done only by personnel trained, supervised and equipped according to Federal OSHA regulations.

## Demounting

Completely deflate tire by removing the valve core prior to removing the tire and wheel assembly from the truck.

Remove tire and wheel assembly from the vehicle and demount the tire from the wheel in the following manner:

### Tube-type

- Ensure that the tire is completely deflated before removing from the rim. Place the tire on the floor, side-ring side up.
- Pry the bead loose from the lock ring using the proper tools.
- Disassemble the rim parts carefully to avoid damage to the tire, tube, flap or rim parts.
- Turn the wheel over and unseat the second bead from the wheel.
- Remove the rim from the tire.

### Tubeless

- Ensure that the tire is completely deflated before removing from the rim.
- Break the beads loose on both sides of the tire using a bead-breaking tool.
- Lubricate both beads of the tire using a vegetable oil-based lubricant only.
- Place the tire and rim on the floor with the wide side of the rim down.
- Progressively work the tire off the rim using the proper tire irons.

### Prior to Mounting

Clean and prepare rim or wheel – inspect the rim or wheel for damage. Cracked, broken, bent, or otherwise damaged rim components and wheels must not be reworked, welded, brazed or otherwise heated. Never weld a rim with a tire mounted on it or any other time.

Proper size tube and flaps (if applicable) must be installed in the tire. New Bridgestone tubes and flaps must be used when mounting new Bridgestone tube type tires. Never use undersized, oversized, or used tubes or flaps. Ensure that rim components are properly matched and that the proper size rim is being used (size, bead taper, etc.).

New valves, cores, caps, and O-rings should be installed with new tires. Never mount a damaged tire.

## Mounting

### Tube-type

- Remove the tube and flap from the tire (if installed). Clean and dry the inside of the tire to ensure that all moisture, dirt and foreign material is removed prior to mounting.
- Install the proper size tube and flap. Always install new Bridgestone radial tubes and radial flaps in new Bridgestone radial tires. Be sure tubes marked “radial” are used in radial tires. Place the tube inside the tire and install the flap, ensuring that the flap is centered. Slightly inflate the tube enough to shape it out.
- Lubricate the beads, rim side of the flap and the tube base with a vegetable-based lubricant. Do not over-lubricate (inside of tire must stay dry).
- Mount the tire, tube and flap assembly on the rim.
- Assemble the rim parts making sure proper components are used and a proper fit is established.
- When inflating, always place the tire in an approved safety cage or equivalent restraining device and use an extension hose and clip-on chuck.
- Never stand over a tire while inflating. Do not attempt to seat rim components by tapping with a mallet when tire is inflated.

### Tubeless

- Clean and prepare rim or wheel.
- Replace valve seals and stem.
- Lubricate both beads and both rim flanges.
- Work the tire over the rim flanges using proper tubeless tire tools.
- Mount the tire over the valve side.
- Inflate tire in safety cage to seat beads.
- Do not exceed the maximum inflation pressures shown on tire sidewall/rim.

**WARNING:** When mounting truck tires, never use pressures above 40 psi to seat tire beads. If beads have not seated by the time pressure reaches 40 psi, deflate the assembly, reposition the tire on the rim, re-lubricate tire beads, rim humps, bead seat, and re-inflate.

### Cautions

- Always inflate tire/rim assembly in an approved safety cage or equivalent restraining device, use remote controlled clip-on air hose, and inflate to pressure recommended by vehicle manufacturer.



- Always ensure that rim components fit properly before inflating.
- Never tap component parts with a mallet while the tire is inflated.
- Never attempt to disassemble multi-piece rims while inflated.
- Do not exceed the maximum inflation pressure on the sidewall of the tire. If beads do not seat at 40 psi, deflate, re-lubricate and re-inflate.

**WARNING:** Never pour or spray any flammable substance into or onto a tire or wheel for any purpose whatsoever. The residue left by the substance could result in a fire or explosion, which could cause an accident.

**WARNING:** Never pour or spray a flammable substance such as gasoline or ethyl ether into a tire and light with a match so that the resulting explosion seats the beads of a tubeless tire. This practice is extremely dangerous and can result in a severe explosion or undetected damage to the tire or rim which can cause severe injury or death.

**WARNING:** Always replace a tire on a rim with another tire of exactly the same bead diameter as the diameter of the rim on which it will be mounted.

## Correct Rim Selection

Bridgestone tires are designed to be used on wheels and rims that conform to the dimensions and contours shown in the Tire and Rim Association Yearbook for the year in which the tire is manufactured and that are designed as approved wheels and rims for each particular tire size and type.

Usage of other wheels and rims must be expressly approved by Bridgestone Firestone North American Tire, LLC for the particular application involved.

The load and cold inflation pressure must not exceed the rim and wheel manufacturer's recommendations even though the tire may be approved for a higher load or inflation.

Rims and wheels may be identified (stamped) with a maximum load and maximum cold inflation rating. For rims and wheels not so identified or for service conditions exceeding the rated capacities, consult the rim and wheel manufacturer to determine rim and wheel capacities for the intended service.

### Tire & Rim Matching Importance

Remember the importance of proper matching of tires and rims. In particular, special care must also be used in the mounting of any 16" diameter tire sizes, as well as the 15.5" and 17.5" sizes. The 16" size tire must be mounted only on the approved 16" rims and not the 15.5" or 16.5" rims. In addition, any 15" size tire must be mounted only on approved 15" rims, not a 15.5" rim and any 17" size tire must be mounted only on approved 17" rims, not on a 17.5" rim.

**WARNING:** There is a danger in installing a tire of one rim diameter on a rim of a different rim diameter. If attempts are made to mount and inflate a 15" diameter tire on a 15.5" rim, a 16" tire on a 16.5" rim, or a 17" tire on a 17.5" rim, serious injury or death may result.

Rims of different diameters and tapers cannot be interchanged. The following diagram illustrates the difference between rims of two different tapers and diameters:

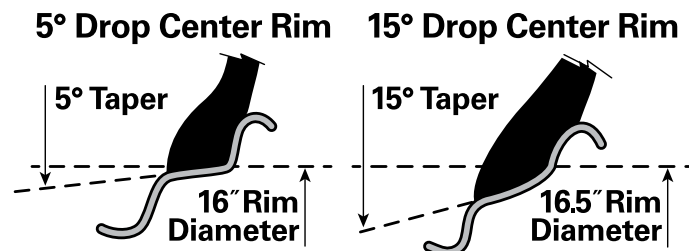

The following diagram shows how the beads of a 16" tire will not seat on a 16.5" rim. The beads should not be forced out against the rim flanges by using more air pressure, because this will break the beads and the tire will explode. Never exceed 40 psi when seating the beads on the rims.



## Use of Lubricants In Mounting & Demounting of Truck/Bus Tires

Bridgestone does not recommend the use of petroleum products as a lubricant in tire mounting or demounting operations.

Only a vegetable oil-based lubricant should be used. Do not use solvents or petroleum products as lubricants for tire mounting or demounting.

In cases where a tire submitted for adjustment consideration for bead-related damages shows evidence of having been contaminated by petroleum lubricants or other non-recommended material, the adjustment will be disallowed by Bridgestone. The use of non-recommended (products or materials may result in deterioration of rubber and eventual failure of the tire.)

Acceptable lubricants such as Murphy's, Ru-Glyde, Sliptac, etc. are recommended for (mounting and demounting passenger and truck/bus tires.)

## Tire Vibration

**SAFETY WARNING:** Serious injury or death may result from a tire failure. Many tire failures are preceded by vibration, bumps, bulges or other anomalies. If an unusual vibration occurs while driving your vehicle or you notice a bump, bulge, or an anomaly not associated with normal tire performance, have your tires and vehicle evaluated by a qualified service person.

## Repair & Retreading

Improperly repaired or retreaded truck tires may cause sudden tire destruction.

Bridgestone truck tires should only be retreaded and repaired by trained personnel.

An inspection of each tire should be done before operating the vehicle. Damaged tires should be inspected by an authorized Bridgestone tire dealer.

A puncture left unrepaired may result in further internal casing damage and eventual tire destruction.

Never use plug-only repairs on Bridgestone truck tires. An interior patch with plug or other approved material is required. Nail hole repairs should be made only after demounting and inspecting the interior of the tire.

Never use a tube as a substitute for a proper tire repair.

### **Belt Removal**

1. The removal of the fourth (outer) belt is permissible. This belt may be omitted when retreading.
2. The removal of the third belt is more involved. If it is essential that the third belt be removed, then it must be replaced before retreading.
3. A nail hole repair of 3/8" or less in diameter may be made in the crown area of either radial or bias tires. A section repair in a radial is required to repair any injury larger than a 3/8" nail hole.
4. Bias section repairs are made when the injury is either larger than 1-1/4" in diameter, is not perfectly round or perpendicular to the liner surface, or when the injury is larger than 3/8" in diameter and combination patch plugs are not used.

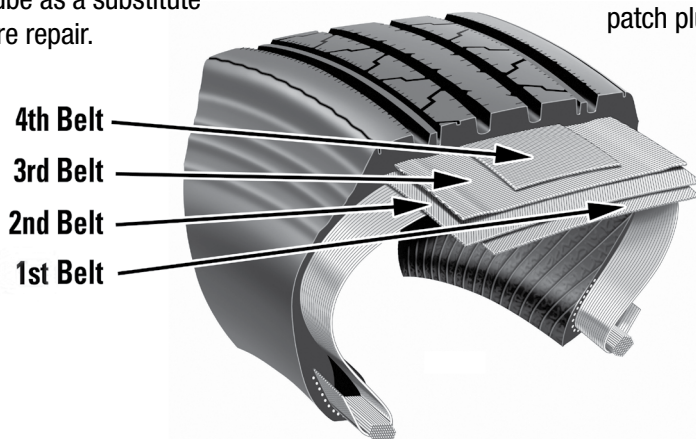

# Large Truck Fuel Economy

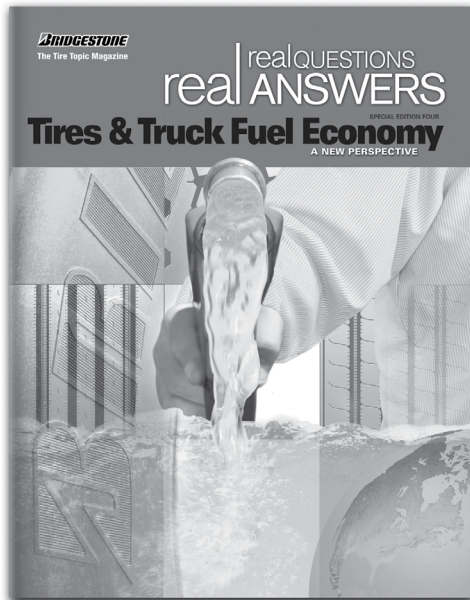

## A NEW PERSPECTIVE

**Anything you do to save fuel will improve your profitability – if it doesn't cost more than it saves.**

Bridgestone Commercial Solutions (BCS) has been studying the relationship of tires to fuel economy for over a quarter of a century. What follows summarizes that research.

For a detailed look at truck tire fuel economy, ask your BCS representative for a copy of **Tires & Truck Fuel Economy**, a Real Answers magazine "Special Edition." You may also view this publication online or order copies by visiting [commercial.firestone.com](http://commercial.firestone.com).

Today's trucks have an estimated engine efficiency of approximately 40 percent. Therefore, only about 40 percent of the energy converted from diesel fuel reaches the axles. Some things influence use of this 40 percent of available energy more than others. We'll take them in order, starting with some of the largest.

## What affects "real world" fuel economy?

Just as trucking is "a business of pennies," so is truck fuel economy. Tires are just one of many components affecting fuel economy, but one of the easiest to change and test.

Remember though, because of the difficulty of controlling variables in the real world, test results can vary considerably from what you find in day-to-day operations.

### Factors Affecting Fuel Economy in the Real World

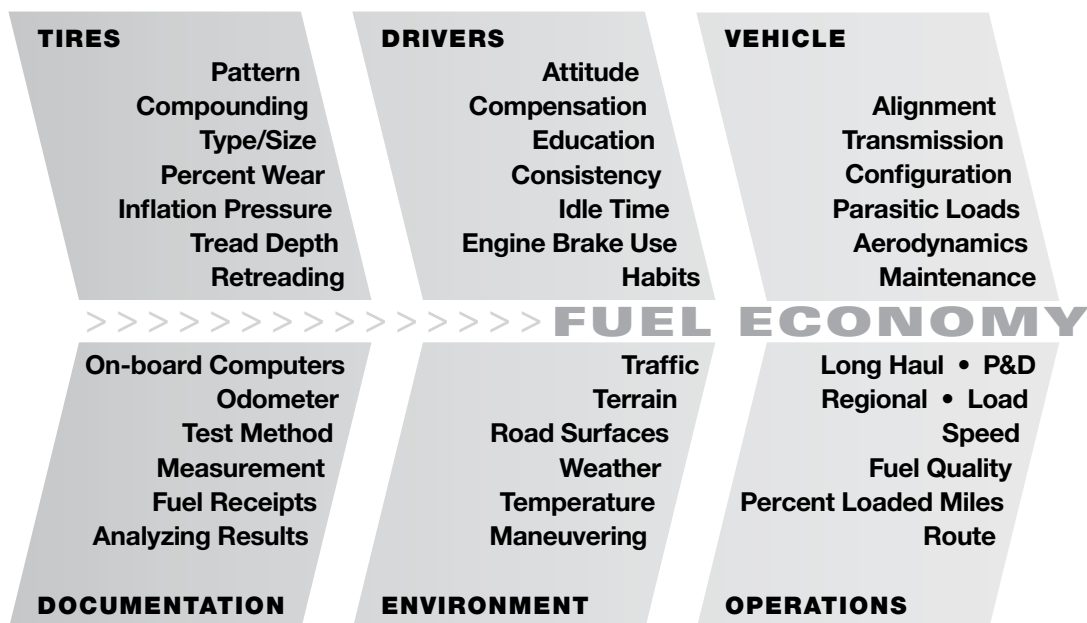

## How much benefit can we get?

A fleet with average fuel economy of 5.0 miles per gallon that achieves a given percentage of fuel savings will save more fuel than a fleet with an average fuel economy of 7.0 miles per gallon.

Fleet size and annual miles also have an effect. The more fuel you use, the more you have to gain from any improvement.

SAMPLE FUEL ECONOMY CALCULATIONS							
MILES PER YEAR	100,000	100,000	100,000	100,000	100,000	100,000	100,000
MILES PER GALLON	5.0	5.5	6.0	6.5	7.0	7.5	8.0
GALLONS PER YEAR	20,000	18,182	16,667	15,385	14,286	13,333	12,500
<b>1% Fuel Savings</b>	<b>200</b>	182	167	154	<b>143</b>	133	125
<b>2% Fuel Savings</b>	400	364	333	308	286	267	250
<b>5% Fuel Savings</b>	1,000	909	833	769	714	667	625
<b>7% Fuel Savings</b>	1,400	1,273	1,167	1,077	1,000	933	875
<b>10% Fuel Savings</b>	2,000	1,818	1,667	1,538	1,429	1,333	1,250

## How do we know how much we're saving?

First, you have to know what your fuel economy is right now. Because it changes constantly, with weather, loads, roads, equipment and drivers, that may not be as simple as it sounds.

Scientific testing controls variables, but you may not have that kind of control in the real world.

And, in-truck on-board computers may not be your best guide. According to TMC, these displays can be in error plus or minus five percent.

**According to TMC, on-board computer displays of fuel economy can be off by ±5%**

One method that's real world is to take your fuel receipts and corresponding odometer readings, then divide miles by gallons. The more data you have, the more representative your "average" is going to be.

And remember, consider the cost of any fuel economy tactic. If it costs more than it saves, it's a bad investment.

## Advanced computer methods

Your BCS representative has an innovative computer program that accurately compares the fuel economy of different tires, tires from different manufacturers, even retreads.

This program, **Tire Life Cycle Cost (TLCC)**, makes a true comparison by compensating for the fact that tire fuel economy changes constantly throughout tread life, and by accounting for differences in tire prices, casing values, installation costs and tread life.

TLCC will show you not only what the costs are, but what portion are for tread wear and what portion are for fuel consumed by the tires.

It's the most accurate "What if?"-way to select tires that will perform best. And only BCS has TLCC. Ask your representative to show you how much you can save.

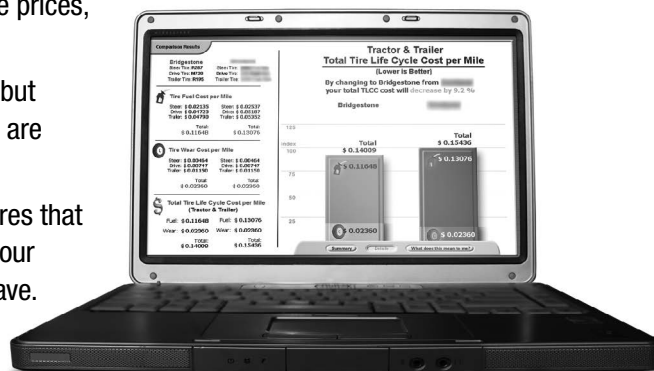

# What consumes fuel?

## SPEED

Every bit of energy produced or used by a truck comes from the fuel in the tank.

To move a truck, you must first run the engine to get power to the tires. With 40 percent engine efficiency, 60 percent of fuel is consumed through engine losses, the remaining 40 percent of fuel is consumed by tire rolling resistance, air resistance and all other mechanical losses. At 55 mph or below tire rolling resistance, air resistance and mechanical losses each account for about 33 percent of the 40 percent of fuel from the engine efficiency.

For example, increasing speed from 55 mph to 75 mph can take 39 percent more fuel, and much of that results from air resistance.

### Speed affects other things too

In tests, vehicles went from 5.1 miles per gallon at 75 mph to 7.1 miles per gallon at 55 mph.

Speed also affects travel time, and therefore, the number of miles a driver can log each day. If you can meet delivery schedules without running out of hours of service, cutting speed can be an effective way to save fuel.

### Fuel Economy at Different Speeds

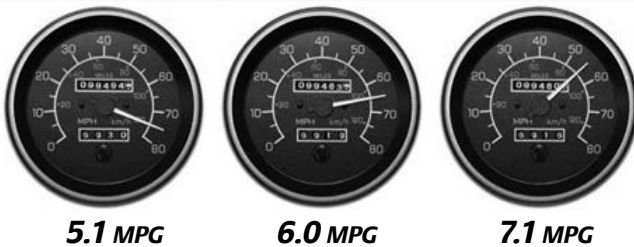

### Fuel Economy & Travel Time at Different Speeds

Running at higher speeds can also have effects: Tire fuel efficiency, even with fuel-efficient tires, is severely cut.

And, engine manufacturers estimate maintenance costs may be 10-15 percent higher, while tire wear can be shortened by 10 to 30 percent.

SPEED	MILES PER GALLON	INCREASE IN MILES PER GALLON	PERCENT FUEL SAVED	TIME FOR 500 MILES OF TRAVEL	INCREASE IN TRAVEL TIME
75	5.1	—	—	6 hr. 40 min.	—
65	6.0	18%	15%	7 hr. 42 min.	15.5%
55	7.1	39%	28.2%	9 hr. 5 min.	36.2%

## Effect of Speed on Fuel Efficiency Factors

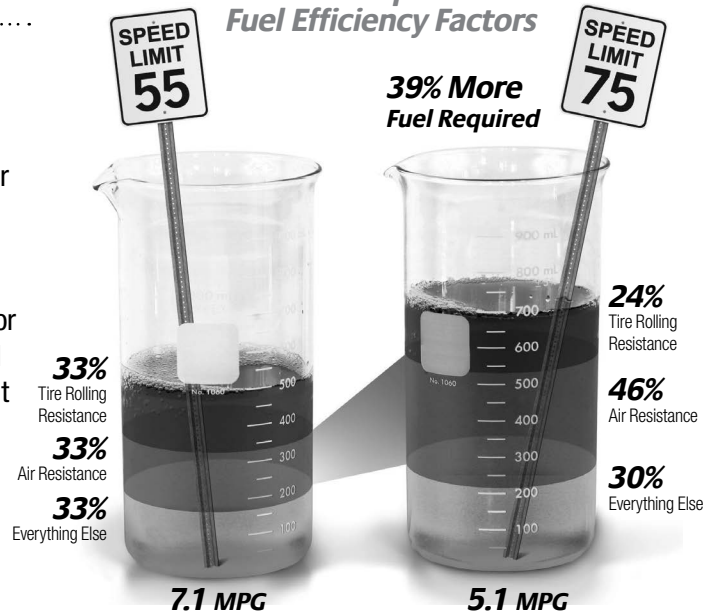

## LOAD

No one would reduce payload as a way to save fuel, but there are ways to increase payload – by decreasing non-paying load.

Wide base tires weigh significantly less than dual pairs. With some cargoes, this can allow increased payload, and more revenue.

If the tires they replace were not fuel-efficient, wide base tires may also contribute to fuel economy.



**WIDE BASE**  
181 lb per TIRE

**LOW PROFILE**  
250 lb per PAIR

Wide base tires can allow weight savings to be converted into revenue-producing payload and may be more fuel-efficient than ordinary dual assemblies.

### Tire Contributions to the Fuel Bill

Of the fuel used in moving the vehicle, about 1/4 to 1/3 of it is used to overcome rolling resistance. So if rolling resistance decreases by 10 percent the result is about (1/4 x 10% =) 2.5% to (1/3 x 10% =) 3% decrease in fuel consumption.

**What consumes fuel?**

continued

**ROLLING RESISTANCE**

The tread contributes about 35-50 percent of the tire's overall rolling resistance, while the casing contributes about 50 to 65 percent.

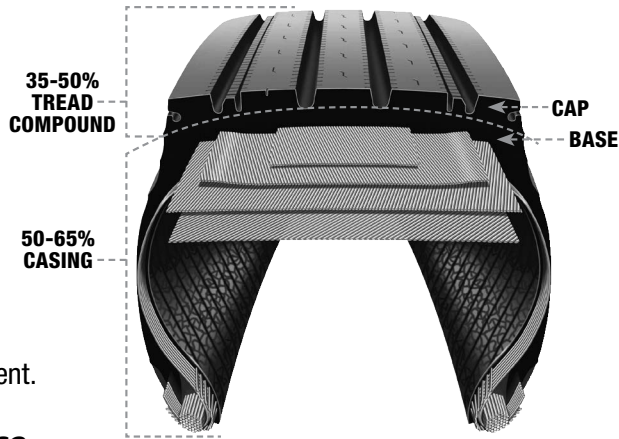

**Wear effect on rolling resistance**

Since the contribution of the tread is large, as the tread wears away, rolling resistance decreases.

As they approach wear-out, many tires become very similar in rolling resistance, even if they started out quite different.

That's one reason the BCS TLCC program uses true average rolling resistance – not new-tire rolling resistance – to calculate tire fuel consumption.



**Tread design**

Tread design also affects rolling resistance. In general, rib-type designs are more fuel-efficient than block- or lug-types. And, a tire with a shallower tread tends to be more fuel-efficient.

With drive tires, designs incorporating continuous shoulder ribs are so resistant to irregular wear that designers can use very fuel-efficient tread compounds.

Computer analysis, like that of the BCS TLCC program, can help you decide which tires deliver the best fuel efficiency.

**Fuel economy with retreads**

If only the tread is modified to produce fuel economy, the fuel efficiency of the tire may end when it is retreaded, unless it's retreaded with a fuel-efficient tread.

Fortunately, there are a number of fuel-efficient retread materials available offering fuel economy comparable to that of the best new tires, but at a fraction of their cost.

In addition, many BCS casings are specially constructed for fuel efficiency, and when retreaded – especially when capped with a fuel-efficient tread – may help to improve fuel economy.

**Inflation pressure effects**

Inflation pressure effects are relatively small, but you can expect about a 2 percent improvement in fuel efficiency over a range of 20 PSI below to 20 PSI above recommended pressure.

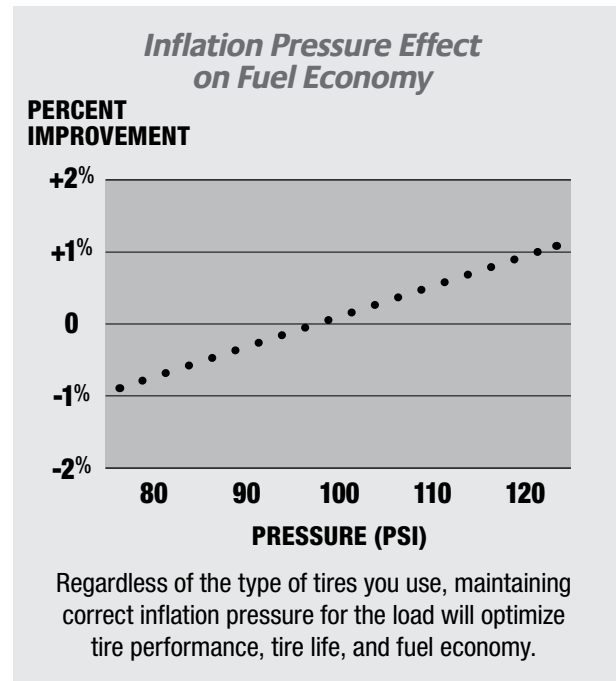

### Position contribution to fuel economy

In general, the contribution of the tires on any given axle to overall vehicle fuel efficiency is roughly determined by the amount of load on that axle.

In general, trailer tires make the largest contribution.

If you are evaluating tires, you should probably try fuel-efficient trailer tires first. If that doesn't work, changing drive and steer tires probably won't either.

### Axle Weight Distribution & Position Contribution to Fuel Economy

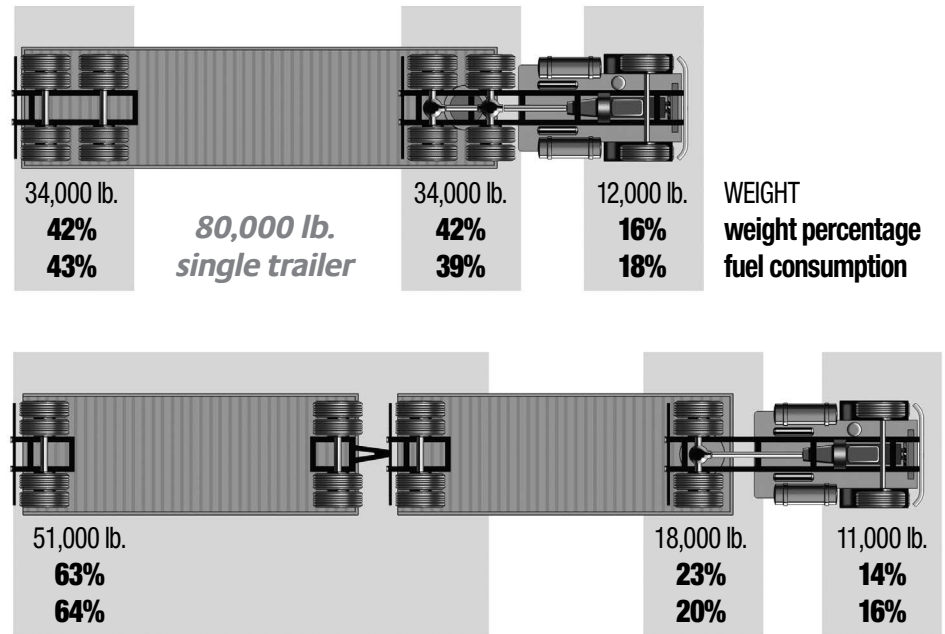

### What effect can fuel-efficient tires have?

Generally you will only see about half of the scientific test results in the real world. Much of this is because of interference by other factors outside the controlled variables of testing.

So, any fuel economy method that does not produce at least a 2-percent improvement in controlled testing will probably not produce a measurable real-world effect.

### Taking action

BCS recommends you conduct your own tests to determine whether your investment will achieve a satisfactory return.

Comparing fuel receipts with odometer readings is something you can do yourself, on an ongoing basis, to see if your fuel economy program is working.

### Try TLCC































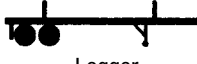



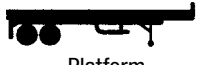



Remember, only BCS has the **Tire Life Cycle Cost (TLCC)** program, to help you make informed tire choices. Your BCS representative will help you analyze your current tires (even if they are from BCS competitors), and recommend tires that will produce the lowest overall tire and fuel cost over their useful life.

Here are some steps to take:

### Recommendations

- 1 Test things yourself:** If you can't convince yourself and your accountant, what you're saving may be too small to stand out from the "noise."
- 2 Limit your investment:** Try trailer tires first, or better still, try fuel-efficient trailer retreads first.
- 3 Consider all the variables:** Fuel-efficient duals may save just as much fuel as wide base tires, without forcing you to buy new wheels. If you can't benefit from the weight savings, why spend the money?
- 4 Try other methods:** Driver behavior has a big effect on fuel economy. Driver training or incentives may be a better investment than new equipment.
- 5 Examine your priorities:** Make sure everyone is on board. If one department is trying to save fuel and another is trying to cut tire costs, they may be working against each other.
- 6 Call for help:** Your tire supplier can help you with advice and in conducting tests. Call BCS for assistance at 1-800-847-3272.

# Truck Type by Weight Class

<p>CLASS 1 6,000 lb &amp; less</p>	 Utility Van  Pick-up	 Compact Van  Multi-purpose	 Van
<p>CLASS 2 6,001-10,000 lb</p>	 Utility Van  Pick-up	 Compact Van  Walk-in	 Doubles
<p>CLASS 3 10,001-14,000 lb</p>	 Milk Bread  Compact Van	 Walk-in	 Liquid Tanker
<p>CLASS 4 14,001-16,000 lb</p>	 Conventional Van  Large Walk-in		 Dry Bulk
<p>CLASS 5 16,001-19,500 lb</p>	 Rack  Large Walk-in	 Tree Specialist	 Logger
<p>CLASS 6 19,501-26,000 lb</p>	 Furniture  Coe Van	 School  Single Axle Van	 Platform
<p>CLASS 7 26,001-33,000 lb</p>	 Home Fuel  Trash	 Transit  Medium Conventional	 Drop Frame
<p>CLASS 8 33,001 lb &amp; over</p>	 Dump  Cement	 Extra Heavy Tandem Conventional  Coe Sleeper	 Dump
			 Reefer
			 Deep Drop
			 Auto Trans

Note: Trailer weight not listed.



## Load & Inflation Tables

<b>Medium Truck Tires</b> .....	74 - 76
<i>Radial Ply Metric Tires on 15° Drop Center Rims</i> .....	74 - 75
<i>Radial Ply Metric Wide Base Tires as Singles</i> .....	75
<i>Radial Ply Tires on 15° Drop Center Rims</i> .....	76
<b>Commercial Light Truck Tires</b> .....	77 - 79
<i>Radial Ply Metric Tires on 5° Drop Center Rims</i> .....	77
<i>Radial Ply Tires on 5° Drop Center Rims</i> .....	78
<i>Diagonal Bias Ply Tires on 5° Drop Center Rims</i> .....	79

# Medium Truck Tires

Radial Ply **METRIC** Tires for Trucks, Buses & Trailers Used in Normal Highway Service

## TIRES MOUNTED ON 15° DROP CENTER RIMS

TIRE SIZE DESIGNATION	USAGE	Tire Load Limits (kg./lb.) at various Cold Inflation Pressures (Pressure Listed is the Minimum for the Load)												
		kPa	480	520	550	590	620	660	690	720	760	790	830	860
		psi	70	75	80	85	90	95	100	105	110	115	120	125
215/75R17.5 <b>FS560 PLUS ONLY</b>	DUAL	kg.			1450	1520	1590	1650	1720	1790	1860	1910	1990	2060(H) <sup>133</sup>
		lb.			3195	3350	3500	3645	3795	3945	4095	4220	4390	4540(H)
	SINGLE	kg.			1530	1610	1680	1750	1820	1900	1960	2040	2110	2180(H) <sup>135</sup>
		lb.			3375	3540	3695	3860	4010	4180	4330	4495	4650	4805(H)
225/70R19.5	DUAL	kg.	1230	1300	<b>1360(E)<sup>119</sup></b>	1410	1470	<b>1550(F)<sup>123</sup></b>	1580	1640	<b>1700(G)<sup>126</sup></b>			
		lb.	2720	2860	<b>3000(E)<sup>119</sup></b>	3115	3245	<b>3415(F)<sup>123</sup></b>	3490	3615	<b>3750(G)<sup>126</sup></b>			
	SINGLE	kg.	1310	1380	<b>1450(E)<sup>121</sup></b>	1500	1570	<b>1650(F)<sup>125</sup></b>	1690	1740	<b>1800(G)<sup>128</sup></b>			
		lb.	2895	3040	<b>3195(E)<sup>121</sup></b>	3315	3450	<b>3640(F)<sup>125</sup></b>	3715	3845	<b>3970(G)<sup>128</sup></b>			
245/70R19.5 <b>FS561</b>	DUAL	kg.			1550	1590	1660	<b>1750(F)<sup>127</sup></b>	1790	1850	<b>1950(G)<sup>131</sup></b>			
		lb.			3415	3515	3655	<b>3860(F)<sup>127</sup></b>	3940	4075	<b>4300(G)<sup>131</sup></b>			
	SINGLE	kg.			1600	1700	1770	<b>1850(F)<sup>129</sup></b>	1900	1970	<b>2060(G)<sup>133</sup></b>			
		lb.			3640	3740	3890	<b>4080(F)<sup>129</sup></b>	4190	4335	<b>4540(G)<sup>133</sup></b>			
245/70R19.5 <b>FS561</b>	DUAL	kg.				1590	1660	1750	1790	1850	<b>1985(G)<sup>131</sup></b>			
		lb.				3515	3655	3860	3940	4075	<b>4375(G)<sup>131</sup></b>			
	SINGLE	kg.				1700	1770	1850	1900	1970	<b>2060(G)<sup>133</sup></b>			
		lb.				3740	3890	4080	4190	4335	<b>4545(G)<sup>133</sup></b>			

		kPa	480	520	550	590	620	660	690	720	760	790	830
		psi	70	75	80	85	90	95	100	105	110	115	120
255/70R22.5	DUAL	kg.			1800	1860	1940	2000	2020	2090	<b>2120(G)<sup>134</sup></b>	2230	<b>2300(H)<sup>137</sup></b>
		lb.			3970	4110	4275	4410	4455	4610	<b>4675(G)<sup>134</sup></b>	4915	<b>5070(H)<sup>137</sup></b>
	SINGLE	kg.			1900	1980	2060	2120	2220	2300	<b>2360(G)<sup>138</sup></b>	2450	<b>2500(H)<sup>140</sup></b>
		lb.			4190	4370	4550	4675	4895	5065	<b>5205(G)<sup>138</sup></b>	5400	<b>5510(H)<sup>140</sup></b>
275/70R22.5	DUAL	kg.				2180	2300	2430	2500	2575	2725	2800	<b>2900(H)<sup>145</sup></b>
		lb.				4805	5070	5355	5510	5675	6005	6175	<b>6395(H)<sup>145</sup></b>
	SINGLE	kg.				2430	2500	2650	2725	2900	3000	3075	<b>3175(H)<sup>146</sup></b>
		lb.				5355	5510	5840	6005	6395	6610	6940	<b>7000(H)<sup>146</sup></b>
295/75R22.5	DUAL	kg.	1860	1950	2060	2130	2220	<b>2300(F)<sup>137</sup></b>	2390	2470	<b>2575(G)<sup>141</sup></b>	2630	<b>2725(H)<sup>143</sup></b>
		lb.	4095	4300	4540	4690	4885	<b>5070(F)<sup>137</sup></b>	5260	5440	<b>5675(G)<sup>141</sup></b>	5795	<b>6005(H)<sup>143</sup></b>
	SINGLE	kg.	2040	2140	2240	2340	2440	<b>2500(F)<sup>140</sup></b>	2620	2710	<b>2800(G)<sup>144</sup></b>	2890	<b>3000(H)<sup>148</sup></b>
		lb.	4500	4725	4940	5155	5370	<b>5510(F)<sup>140</sup></b>	5780	5980	<b>6175(G)<sup>144</sup></b>	6370	<b>6610(H)<sup>148</sup></b>
295/75R22.5 <b>FS591 ONLY</b>	DUAL	kg.	1860	1950	2060	2130	2220	<b>2300(F)<sup>137</sup></b>	2390	2470	<b>2575(G)<sup>141</sup></b>	2870	<b>3000(H)<sup>148</sup></b>
		lb.	4095	4300	4540	4690	4885	<b>5070(F)<sup>137</sup></b>	5260	5440	<b>5675(G)<sup>141</sup></b>	6330	<b>6610(H)<sup>148</sup></b>
	SINGLE	kg.	2040	2140	2240	2340	2440	<b>2500(F)<sup>140</sup></b>	2620	2710	<b>2800(G)<sup>144</sup></b>	3150	<b>3250(H)<sup>149</sup></b>
		lb.	4500	4725	4940	5155	5370	<b>5510(F)<sup>140</sup></b>	5780	5980	<b>6175(G)<sup>144</sup></b>	6950	<b>7160(H)<sup>149</sup></b>

		kPa	550	590	620	660	690	720	760	790	830	860	900
		psi	80	85	90	95	100	105	110	115	120	125	130
275/70R22.5 <b>FS561 PLUS Load Range "J" Only</b>	DUAL	kg.		2235	2334	2417	2483	2545	2625	2685	2765	2825	<b>2900(J)<sup>140</sup></b>
		lb.		4925	5145	5327	5470	5610	5785	5915	6095	6225	<b>6395(J)<sup>140</sup></b>
	SINGLE	kg.		2425	2533	2627	2696	2764	2852	2918	3005	3067	<b>3150(J)<sup>140</sup></b>
		lb.		5345	5580	5790	5940	6090	6285	6430	6620	6760	<b>6940(J)<sup>140</sup></b>

NOTES: Letters in parentheses denote Load Range for which boldface loads and inflations are maximum. International Load Index numbers are shown after Load Range.

IMPORTANT — Always use approved tire and rim combinations for diameter and contours.

# Medium Truck Tires

Radial Ply **METRIC** Tires for Trucks, Buses & Trailers Used in Normal Highway Service

## TIRES MOUNTED ON 15° DROP CENTER RIMS

TIRE SIZE DESIGNATION	USAGE	Tire Load Limits (kg./lb.) at various Cold Inflation Pressures (Pressure Listed is the Minimum for the Load)											
		kPa	550	590	620	660	690	720	760	790	830	860	900
		psi	80	85	90	95	100	105	110	115	120	125	130
305/70R22.5	Dual	kg.	4805	5070	5355	5510	5840	6005	6395	6610	<b>6780</b>	6940	<b>7390</b>
		lb.											
	Single	kg.	5510	5675	6005	6395	6610	6780	7160	7390	<b>7610</b>	7830	<b>8050</b>
		lb.											
315/80R22.5	Dual	kg.	2575	2650	2750	2900	2970	3070	3150	3270	<b>3450(J)<sup>151</sup></b>	3590	<b>3750(L)<sup>154</sup></b>
		lb.											
	Single	kg.	2800	2910	3030	3150	3260	3370	3450	3590	<b>3750(J)<sup>154</sup></b>	3940	<b>4125(L)<sup>157</sup></b>
		lb.											
315/80R22.5 <b>FS400</b>	Dual	kg.	2575	2650	2750	2900	2970	3070	3150	3270	<b>3450(J)<sup>151</sup></b>	3725	<b>4000(L)<sup>156</sup></b>
		lb.											
	Single	kg.	2800	2910	3030	3150	3260	3370	3450	3590	<b>3750(J)<sup>154</sup></b>	4000	<b>4250(L)<sup>158</sup></b>
		lb.											

TIRE SIZE DESIGNATION	USAGE	kPa	480	520	550	590	620	660	690	720	760	790	830
		psi	70	75	80	85	90	95	100	105	110	115	120
		285/75R24.5	DUAL	kg.	1870	1970	2060	2150	2240	<b>2360(F)<sup>138</sup></b>	2410	2490	<b>2575(G)<sup>141</sup></b>
lb.	4135			4340									
SINGLE			kg.		2060	2160	2240	2360	2460	<b>2575(F)<sup>141</sup></b>	2650	2740	<b>2800(G)<sup>144</sup></b>
	lb.		4545	4770									

## METRIC WIDE BASE Radial Tires for Trucks, Buses & Trailers Used in Normal Highway Service

### TIRES ARE USED AS SINGLES

TIRE SIZE DESIGNATION	Tire Load Limits (kg./lb.) at various Cold Inflation Pressures (Pressure Listed is the Minimum for the Load)											
	kPa	480	520	550	590	620	660	690	720	760	790	830
	psi	70	75	80	85	90	95	100	105	110	115	120
385/65R22.5	kg.	2880	3060	3150	3350	3470	3650	3740	3850	4000	4100	<b>4250(J)<sup>158</sup></b>
	lb.											
425/65R22.5	kg.	3430	3640	3750	3980	4130	4250	4440	4580	<b>4750(J)<sup>162</sup></b>	4880	<b>5150(L)<sup>165</sup></b>
	lb.											
445/65R22.5	kg.	3720	3950	4125	4320	4470	4625	4820	4960	5150	5290	<b>5600(L)<sup>168</sup></b>
	lb.											

NOTES: Letters in parentheses denote Load Range for which boldface loads and inflations are maximum.

International Load Index numbers are shown after Load Range.

IMPORTANT — Always use approved tire and rim combinations for diameter and contours.

# Medium Truck Tires

Radial Ply Tires for Trucks, Buses & Trailers Used in Normal Highway Service

## TIRES MOUNTED ON 15° DROP CENTER RIMS

TIRE SIZE DESIGNATION	USAGE	Tire Load Limits (kg./lb.) at various Cold Inflation Pressures (Pressure Listed is the Minimum for the Load)											
		kPa	480	520	550	590	620	660	690	720	760	790	830
		psi	70	75	80	85	90	95	100	105	110	115	120
9R22.5	DUAL	kg.	1480	1550	1610	1670	<b>1750(E)<sup>127</sup></b>	1820	1890	<b>1950(F)<sup>131</sup></b>	2010	2070	<b>2120(G)<sup>134</sup></b>
		lb.	3270	3410	3550	3690	<b>3860(E)</b>	4005	4150	<b>4300(F)</b>	4425	4550	<b>4675(G)<sup>134</sup></b>
	SINGLE	kg.	1530	1610	1690	1760	<b>1850(E)<sup>128</sup></b>	1920	1990	<b>2060(F)<sup>133</sup></b>	2120	2180	<b>2240(G)<sup>136</sup></b>
		lb.	3370	3560	3730	3890	<b>4080(E)</b>	4235	4390	<b>4540(F)</b>	4675	4810	<b>4940(G)</b>
10R22.5	DUAL	kg.	1750	1830	1910	<b>2000(E)<sup>132</sup></b>	2080	2160	<b>2240(F)<sup>138</sup></b>	2300	2360	<b>2430(G)<sup>138</sup></b>	
		lb.	3860	4045	4230	<b>4410(E)</b>	4585	4760	<b>4940(F)</b>	5075	5210	<b>5355(G)</b>	
	SINGLE	kg.	1850	1940	2030	<b>2120(E)<sup>134</sup></b>	2200	2280	<b>2360(F)<sup>138</sup></b>	2430	2500	<b>2575(G)<sup>141</sup></b>	
		lb.	4080	4280	4480	<b>4675(E)</b>	4850	5025	<b>5205(F)</b>	5360	5515	<b>5675(G)</b>	
11R22.5	DUAL	kg.	1990	2080	2160	2250	<b>2360(F)<sup>138</sup></b>	2460	2560	<b>2650(G)<sup>142</sup></b>	2680	2710	<b>2725(H)<sup>143</sup></b>
		lb.	4380	4580	4760	4950	<b>5205(F)</b>	5415	5625	<b>5840(G)</b>	5895	5950	<b>6005(H)</b>
	SINGLE	kg.	2050	2160	2260	2370	<b>2500(F)<sup>140</sup></b>	2600	2700	<b>2800(G)<sup>144</sup></b>	2870	2940	<b>3000(H)<sup>146</sup></b>
		lb.	4560	4770	4990	5220	<b>5510(F)</b>	5730	5950	<b>6175(G)</b>	6320	6465	<b>6610(H)</b>
11R24.5	DUAL	kg.	2110	2210	2300	2390	<b>2500(F)<sup>140</sup></b>	2580	2660	<b>2725(G)<sup>143</sup></b>	2820	2910	<b>3000(H)<sup>146</sup></b>
		lb.	4660	4870	5070	5260	<b>5510(F)</b>	5675	5840	<b>6005(G)</b>	6205	6405	<b>6610(H)</b>
	SINGLE	kg.	2190	2300	2410	2520	<b>2650(F)<sup>142</sup></b>	2770	2890	<b>3000(G)<sup>146</sup></b>	3080	3160	<b>3250(H)<sup>149</sup></b>
		lb.	4820	5070	5310	5550	<b>5840(F)</b>	6095	6350	<b>6610(G)</b>	6790	6970	<b>7160(H)</b>
12R22.5	DUAL	kg.	2170	2260	2350	2440	<b>2575(F)<sup>141</sup></b>	2630	2680	<b>2725(G)<sup>143</sup></b>	2840	2960	<b>3075(H)<sup>147</sup></b>
		lb.	4780	4990	5190	5390	<b>5675(F)</b>	5785	5895	<b>6005(G)</b>	6265	6525	<b>6780(H)</b>
	SINGLE	kg.	2240	2360	2470	2580	<b>2725(F)<sup>143</sup></b>	2820	2910	<b>3000(G)<sup>146</sup></b>	3120	3240	<b>3350(H)<sup>150</sup></b>
		lb.	4940	5000	5450	5690	<b>6005(F)</b>	6205	6405	<b>6610(G)</b>	6870	7130	<b>7390(H)</b>
12R24.5	DUAL	kg.	2300	2400	2500	2600	<b>2650(F)<sup>142</sup></b>	2770	2890	<b>3000(G)<sup>146</sup></b>	3080	3160	<b>3250(H)<sup>149</sup></b>
		lb.	5080	5300	5520	5730	<b>5840(F)</b>	6095	6350	<b>6610(G)</b>	6790	6970	<b>7160(H)</b>
	SINGLE	kg.	2380	2500	2630	2740	<b>2900(F)<sup>145</sup></b>	3020	3140	<b>3250(G)<sup>152</sup></b>	3350	2450	<b>3550(H)<sup>152</sup></b>
		lb.	5240	5520	5790	6040	<b>6395(F)</b>	6650	6910	<b>7160(G)</b>	7380	7600	<b>7830(H)</b>

NOTES: Letters in parentheses denote Load Range for which boldface loads and inflations are maximum.

International Load Index numbers are shown after Load Range.

IMPORTANT — Always use approved tire and rim combinations for diameter and contours.

# Commercial Light Truck Tires

Light Truck **METRIC** Radial Ply Tires for Trucks, Buses, Trailers & Multipurpose Passenger Vehicles Used in Normal Highway Service

TIRES MOUNTED ON 5° DROP CENTER RIMS												
TIRE SIZE DESIGNATION	USAGE	Tire Load Limits (lb.) at various Cold Inflation Pressures										
		kPa	250	275	300	350	380	400	450	480	500	550
		psi	35	40	45	50	55	60	65	70	75	80
LT285/60R20	DUAL	kg.	865	916	975	1060	1145	1190	1285	1356	1390	<b>1500(E)<sub>122</sub></b>
		lb.	1840	2020	2195	2335	2525	2685	2835	2990	3135	<b>3305(E)</b>
	SINGLE	kg.	950	1007	1070	1180	1259	1310	1400	1490	1530	<b>1650(E)<sub>125</sub></b>
		lb.	2020	2220	2410	2600	2775	2950	3085	3285	3445	<b>3640(E)</b>
LT275/65R18	DUAL	kg.	820	880	930	<b>1060(C)<sub>110</sub></b>	1095	1140	<b>1250(D)<sub>116</sub></b>	1300	1130	<b>1400(E)<sub>120</sub></b>
		lb.	1765	1940	2100	<b>2335(C)</b>	2420	2570	<b>2755(D)</b>	2865	3010	<b>3085(E)</b>
	SINGLE	kg.	900	965	1020	<b>1150(C)<sub>113</sub></b>	1205	1250	<b>1360(D)<sub>119</sub></b>	1425	1450	<b>1550(E)<sub>123</sub></b>
		lb.	1940	2130	2310	<b>2535(C)</b>	2660	2825	<b>3000(D)</b>	3150	3305	<b>3415(E)</b>
LT245/70R17	DUAL	kg.	715	765	810	<b>900(C)<sub>104</sub></b>	955	990	<b>1060(D)<sub>110</sub></b>	1130	1160	<b>1250(E)<sub>116</sub></b>
		lb.	1540	1690	1830	<b>1985(C)</b>	2105	2240	<b>2335(D)</b>	2495	2615	<b>2755(E)</b>
	SINGLE	kg.	785	840	890	<b>1000(C)<sub>108</sub></b>	1050	1090	<b>1180(D)<sub>114</sub></b>	1240	1270	<b>1360(E)<sub>119</sub></b>
		lb.	1690	1855	2010	<b>2205(C)</b>	2315	2460	<b>2600(D)</b>	2740	2875	<b>3000(E)</b>
LT265/70R17	DUAL	kg.	800	855	910	<b>1030(C)<sub>109</sub></b>	1070	1110	<b>1060(D)<sub>110</sub></b>	1240	1260	<b>1320(E)<sub>118</sub></b>
		lb.	1720	1890	2050	<b>2270(C)</b>	2360	2510	<b>2680(D)</b>	2735	2820	<b>2910(E)</b>
	SINGLE	kg.	880	920	1000	<b>1120(C)<sub>112</sub></b>	1175	1220	<b>1215(D)<sub>114</sub></b>	1360	1390	<b>1450(E)<sub>121</sub></b>
		lb.	1890	2075	2255	<b>2470(C)</b>	2595	2760	<b>2910(D)</b>	3005	3100	<b>3195(E)</b>
LT265/70R18	DUAL	kg.	830	889	945	1060	1111	1160	1285	1315	1350	<b>1450(E)<sub>121</sub></b>
		lb.	1785	1960	2130	2335	2450	2605	2835	2900	3045	<b>3195(E)</b>
	SINGLE	kg.	910	977	1040	1150	1220	1270	1400	1444	1480	<b>1600(E)<sub>124</sub></b>
		lb.	1960	2155	2340	2535	2690	2860	3085	3185	3345	<b>3525(E)</b>
LT275/70R18	DUAL	kg.	875	935	990	<b>1120(C)<sub>112</sub></b>	1175	1220	<b>1320(D)<sub>118</sub></b>	1390	1420	<b>1500(E)<sub>122</sub></b>
		lb.	1885	2065	2250	<b>2470(C)</b>	2585	2750	<b>2910(D)</b>	3060	3210	<b>3305(E)</b>
	SINGLE	kg.	960	1030	1090	<b>1215(C)<sub>115</sub></b>	1290	1340	<b>1450(D)<sub>121</sub></b>	1525	1560	<b>1650(E)<sub>125</sub></b>
		lb.	2070	2270	2470	<b>2680(C)</b>	2840	3020	<b>3195(D)</b>	3360	3530	<b>3640(E)</b>
LT215/75R15	DUAL	kg.	570	608	645	<b>730(C)<sub>97</sub></b>	762	790	<b>875(D)<sub>103</sub></b>			
		lb.	1255	1340	1460	<b>1610(C)</b>	1680	1785	<b>1930(D)</b>			
	SINGLE	kg.	625	669	710	<b>800(C)<sub>100</sub></b>	837	870	<b>950(D)<sub>106</sub></b>			
		lb.	1345	1475	1605	<b>1765(C)</b>	1845	1960	<b>2095(D)</b>			
LT235/75R15	DUAL	kg.	645	694	735	<b>825(C)<sub>101</sub></b>	866	900	<b>975(D)<sub>107</sub></b>	1027	1060	<b>1150(E)<sub>113</sub></b>
		lb.	1390	1530	1660	<b>1820(C)</b>	1910	2035	<b>2150(D)</b>	2265	2375	<b>2535(E)</b>
	SINGLE	kg.	710	762	810	<b>900(C)<sub>104</sub></b>	952	990	<b>1060(D)<sub>110</sub></b>	1129	1160	<b>1250(E)<sub>116</sub></b>
		lb.	1530	1680	1825	<b>1985(C)</b>	2100	2235	<b>2335(D)</b>	2490	2610	<b>2755(E)</b>

NOTES: Letters in parentheses denote Load Range for which boldface loads and inflations are maximum. International Load Index numbers are shown after Load Range.

IMPORTANT — Always use approved tire and rim combinations for diameter and contours.

# Commercial Light Truck Tires

Light Truck **METRIC** Radial Ply Tires for Trucks, Buses, Trailers & Multipurpose Passenger Vehicles Used in Normal Highway Service

## TIRES MOUNTED ON 5° DROP CENTER RIMS

TIRE SIZE DESIGNATION	USAGE	Tire Load Limits (lb.) at various Cold Inflation Pressures										
		kPa	250	275	300	350	380	400	450	480	500	550
		psi	35	40	45	50	55	60	65	70	75	80
LT225/75R16	DUAL	kg.	635	675	725	<b>800(C)</b> <sub>100</sub>	945	885	<b>975(D)</b> <sub>107</sub>	1000	1040	<b>1120(E)</b> <sub>112</sub>
		lb.	1365	1500	1630	<b>1765(C)</b>	1875	1995	<b>2150(D)</b>	2220	2330	<b>2470(E)</b>
	SINGLE	kg.	700	745	795	<b>880(C)</b> <sub>103</sub>	930	970	<b>1060(D)</b> <sub>110</sub>	1100	1140	<b>1215(E)</b> <sub>115</sub>
		lb.	1500	1650	1790	<b>1940(C)</b>	2060	2190	<b>2335(D)</b>	2440	2560	<b>2680(E)</b>
LT245/75R16	DUAL	kg.	720	770	820	<b>910(C)</b> <sub>104</sub>	960	1000	<b>1080(D)</b> <sub>111</sub>	1135	1170	<b>1260(E)</b> <sub>116</sub>
		lb.	1545	1700	1845	<b>2006(C)</b>	2125	2255	<b>2381(D)</b>	2515	2640	<b>2778(E)</b>
	SINGLE	kg.	790	850	900	<b>1000(C)</b> <sub>108</sub>	1055	1100	<b>1190(D)</b> <sub>114</sub>	1250	1290	<b>1380(E)</b> <sub>120</sub>
		lb.	1700	1870	2030	<b>2205(C)</b>	2335	2480	<b>2623(D)</b>	2765	2900	<b>3042(E)</b>
LT265/75R16	DUAL	kg.	810	860	920	<b>1030(C)</b> <sub>109</sub>	1080	1130	<b>1250(D)</b> <sub>116</sub>	1275	1310	<b>1400(E)</b> <sub>120</sub>
		lb.	1740	1910	2075	<b>2270(C)</b>	2390	2540	<b>2755(D)</b>	2825	2965	<b>3085(E)</b>
	SINGLE	kg.	890	950	1010	<b>1120(C)</b> <sub>112</sub>	1185	1240	<b>1360(D)</b> <sub>119</sub>	1400	1440	<b>1550(E)</b> <sub>123</sub>
		lb.	1910	2100	2280	<b>2470(C)</b>	2625	2790	<b>3000(D)</b>	3105	3260	<b>3415(E)</b>
LT225/75R17	DUAL	kg.	665	710	750	<b>850(C)</b> <sub>102</sub>	885	920	<b>1000(D)</b> <sub>108</sub>	1050	1070	<b>1150(E)</b> <sub>113</sub>
		lb.	1425	1565	1695	<b>1875(C)</b>	1950	2075	<b>2205(D)</b>	2310	2430	<b>2535(E)</b>
	SINGLE	kg.	730	780	825	<b>925(C)</b> <sub>105</sub>	970	1010	<b>1090(D)</b> <sub>111</sub>	1155	1180	<b>1250(E)</b> <sub>116</sub>
		lb.	1565	1720	1865	<b>2040(C)</b>	2145	2280	<b>2405(D)</b>	2540	2670	<b>2755(E)</b>
LT215/80R15	DUAL	kg.	590	645	675	750	810	825	<b>875(D)</b> <sub>103</sub>			
		lb.	1275	1395	1515	1655	1745	1855	<b>1930(D)</b>			
	SINGLE	kg.	650	710	740	825	890	905	<b>975(D)</b> <sub>107</sub>			
		lb.	1400	1535	1665	1820	1920	2040	<b>2150(D)</b>			
LT235/80R17	DUAL	kg.	730	800	830	925	1015	1010	1120	1090	1180	<b>1285(E)</b> <sub>117</sub>
		lb.	1570	1725	1870	2040	2190	2315	2470	2560	2685	<b>2835(E)</b>
	SINGLE	kg.	800	880	910	1030	1075	1140	1215	1272	1333	<b>1400(E)</b> <sub>120</sub>
		lb.	1725	1895	2055	2270	2370	2515	2680	2805	2940	<b>3085(E)</b>
LT215/85R16	DUAL	kg.	630	690	720	<b>800(C)</b> <sub>100</sub>	865	870	<b>975(D)</b> <sub>107</sub>	1025	1030	<b>1120(E)</b> <sub>112</sub>
		lb.	1360	1490	1625	<b>1765(C)</b>	1865	1985	<b>2150(D)</b>	2210	2320	<b>2470(E)</b>
	SINGLE	kg.	695	760	790	<b>880(C)</b> <sub>103</sub>	950	965	<b>1060(D)</b> <sub>110</sub>	1130	1130	<b>1215(E)</b> <sub>115</sub>
		lb.	1495	1640	1785	<b>1940(C)</b>	2050	2180	<b>2335(D)</b>	2430	2550	<b>2680(E)</b>
LT235/85R16	DUAL	kg.	720	790	820	<b>910(C)</b> <sub>104</sub>	985	1000	<b>1080(D)</b> <sub>111</sub>	1165	1170	<b>1260(E)</b> <sub>116</sub>
		lb.	1545	1700	1845	<b>2006(C)</b>	2125	2260	<b>2381(D)</b>	2515	2645	<b>2778(E)</b>
	SINGLE	kg.	790	965	900	<b>1000(C)</b> <sub>108</sub>	1100	1155	<b>1190(D)</b> <sub>114</sub>	1285	1290	<b>1380(E)</b> <sub>120</sub>
		lb.	1700	1870	2030	<b>2205(C)</b>	2335	2485	<b>2623(D)</b>	2765	2905	<b>3042(E)</b>
LT255/85R16	DUAL	kg.	815	890	930	<b>1030(C)</b> <sub>109</sub>	1115	1130	<b>1250(D)</b> <sub>116</sub>	1320	1320	<b>1400(E)</b> <sub>120</sub>
		lb.	1745	1920	2085	<b>2270(C)</b>	2400	2550	<b>2755(D)</b>	2840	2980	<b>3085(E)</b>
	SINGLE	kg.	895	980	1020	<b>1120(C)</b> <sub>112</sub>	1225	1240	<b>1360(D)</b> <sub>119</sub>	1450	1450	<b>1550(E)</b> <sub>123</sub>
		lb.	1920	2110	2290	<b>2470(C)</b>	2635	2800	<b>3000(D)</b>	3120	3275	<b>3415(E)</b>

		kPa	250	275	300	325	350	375	400	425	450	475	500	525	550	575
		psi	35	40	45	47	50	54	60	62	65	69	75	76	80	83
205/65R15C	DUAL	kg.	578	624	669	713	757	<b>800(C)</b> <sub>100</sub>								
		lb.	1275	1376	1475	1573	1669	<b>1764(C)</b>								
	SINGLE	kg.	615	663	711	758	804	<b>850(C)</b> <sub>102</sub>								
		lb.	1355	1462	1568	1671	1773	<b>1874(C)</b>								
195/75R16C	DUAL	kg.	554	597	640	683	725	766	806	846	886	<b>925(D)</b> <sub>105</sub>				
		lb.	1220	1317	1412	1505	1597	1688	1777	1866	1953	<b>2039(D)</b>				
	SINGLE	kg.	583	630	675	720	764	807	850	892	934	<b>975(D)</b> <sub>107</sub>				
		lb.	1286	1388	1488	1587	1684	1779	1873	1966	2058	<b>2149(D)</b>				
235/65R16C	DUAL	kg.	698	745	808	862	914	966	1017	1068	1118	1167	1216	1265	1312	<b>1360(E)</b> <sub>119</sub>
		lb.	1540	1662	1782	1899	2016	2130	2243	2354	2464	2573	2681	2788	2893	<b>2998(E)</b>
		kg.	745	804	862	919	975	1030	1085	1139	1192	1244	1297	1348	1399	<b>1450(E)</b> <sub>121</sub>
		lb.	1642	1772	1900	2025	2149	2271	2391	2510	2627	2744	2858	2972	3085	<b>3197(E)</b>

NOTES: Letters in parentheses denote Load Range for which boldface loads and inflations are maximum.

International Load Index numbers are shown after Load Range.

IMPORTANT — Always use approved tire and rim combinations for diameter and contours.

# Commercial Light Truck Tires

Light Truck **RADIAL & BIAS Ply Tires** for Trucks, Buses, Trailers & Multipurpose Passenger Vehicles Used in Normal Highway Service

## TIRES MOUNTED ON 5° DROP CENTER RIMS

TIRE SIZE DESIGNATION	USAGE	Tire Load Limits (kg./lb.) at various Cold Inflation Pressures													
		RADIAL PLY													
		kPa	250	280	310	350	380	410	450	480	520	550	590	620	660
		psi	35	40	45	50	55	60	65	70	75	80	85	90	95
		DIAGONAL (BIAS) PLY													
kPa	210	250	280	310	350	380	410	450	480	520	550	590	620		
psi	30	240	40	45	50	55	60	65	70	75	80	85	90		
8.00R16.5LT 8.00*16.5LT	DUAL	kg.	540	595	640	<b>690(C)<sub>95</sub></b>	735	775	<b>825(D)<sub>101</sub></b>	855	895	<b>925(E)<sub>105</sub></b>	965	1000	<b>1030(F)<sub>109</sub></b>
		lb.	1195	1310	1415	<b>1520(C)</b>	1620	1710	<b>1820(D)</b>	1885	1970	<b>2040(E)</b>	2130	2200	<b>2270(F)</b>
8.75R16.5LT 8.75*16.5LT	SINGLE	kg.	615	675	730	<b>800(C)<sub>100</sub></b>	835	880	<b>925(D)<sub>105</sub></b>	975	1020	<b>1060(E)<sub>110</sub></b>	1100	1130	<b>1180(F)<sub>114</sub></b>
		lb.	1360	1490	1610	<b>1765(C)</b>	1840	1945	<b>2040(D)</b>	2145	2240	<b>2335(E)</b>	2420	2500	<b>2600(F)</b>
8.75R16.5LT 8.75*16.5LT	DUAL	kg.	625	685	740	<b>800(C)<sub>100</sub></b>	840	895	<b>950(D)<sub>105</sub></b>	985	1030	<b>1090(E)<sub>111</sub></b>	1110	1150	<b>1215(F)<sub>115</sub></b>
		lb.	1380	1515	1630	<b>1765(C)</b>	1855	1970	<b>2095(D)</b>	2175	2260	<b>2405(E)</b>	2450	2540	<b>2680(F)</b>
9.50R16.5LT 9.50*16.5LT	SINGLE	kg.	710	780	840	<b>900(C)<sub>104</sub></b>	955	1020	<b>1090(D)<sub>111</sub></b>	1120	1170	<b>1215(E)<sub>115</sub></b>	1260	1310	<b>1360(F)<sub>119</sub></b>
		lb.	1570	1720	1850	<b>1985(C)</b>	2110	2240	<b>2405(D)</b>	2470	2570	<b>2680(E)</b>	2780	2880	<b>3000(F)</b>
9.50R16.5LT 9.50*16.5LT	DUAL	kg.	740	810	875	<b>950(C)<sub>106</sub></b>	1000	1060	<b>1120(D)<sub>112</sub></b>	1170	1220	<b>1285(E)<sub>117</sub></b>			
		lb.	1635	1785	1925	<b>2095(C)</b>	2200	2330	<b>2470(D)</b>	2570	2685	<b>2835(E)</b>			
9.50R16.5LT 9.50*16.5LT	SINGLE	kg.	845	920	995	<b>1090(C)<sub>111</sub></b>	1130	1200	<b>1285(D)<sub>117</sub></b>	1320	1380	<b>1450(E)<sub>121</sub></b>			
		lb.	1860	2030	2190	<b>2405(C)</b>	2500	2650	<b>2835(D)</b>	2920	3050	<b>3195(E)</b>			

NOTES: Letters in parentheses denote Load Range for which boldface loads and inflations are maximum.

International Load Index numbers are shown after Load Range.

IMPORTANT — Always use approved tire and rim combinations for diameter and contours.





# Technical Bulletins

## Title

*Reference Number • Date*

**Factors that Contribute to Heat Buildup in Tires** ..... 82 - 83

*B-08-01 • July 2022*

**DOT Tire ID Number Formats** ..... 84

*P-18-01 • August 2018*

**Truck/Bus Tire Tread Rubber Worn Color Appearance** .... 85

*T-16-10 • June 2016*

**TBR Sidewall Repair & Identification** ..... 86

*T9106TD • April 1996*

**Extra-Deep-Tread Tires' Lateral Stiffness Effects** ..... 87

*T9502TI • October 1995*

**Bridgestone Firestone Chassis Dynamometer Test Guides for Truck/Bus Tires** ..... 88

*T9501X • October 1995*

**Aftermarket Tire Products & Additives in Truck/Bus Tires** ..... 89

*TB-2008-001 • January 2008*

**Aerosol Tire Sealer/Inflators** ..... 90 - 91

*G-008-X • October 1991*

**Innertube Storage** ..... 92

*G-004-X • June 1991*

**Mismatching Tire Bead & Rim Diameters** ..... 93 - 95

*T9106PD • August 1991*

**Mounting Tubeless Truck Tires** ..... 96

*T9101TD • December 1990*

**Steam Cleaning Tires** ..... 97

*T8701GD • October 1987*

### DRIVER INFLUENCED

#### High Speed Driving

Operating tires beyond their maximum speed rating causes excessive heat buildup in the tire which may lead to premature tire removal or possible tire failure.



#### Proper Tire Load

Overloading, which may be caused by the tire being underinflated, causes excessive heat buildup in the tire which may lead to premature tire removal or possible tire failure.

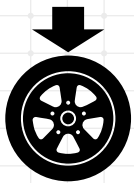

#### Proper Tire Inflation

Under inflation causes excessive heat buildup in the tire which may lead to premature tire removal or possible tire failure.



*Other controllable factors affecting tire heat include repeated hard braking or mechanical issues such as out-of-balance or dragging brakes.*

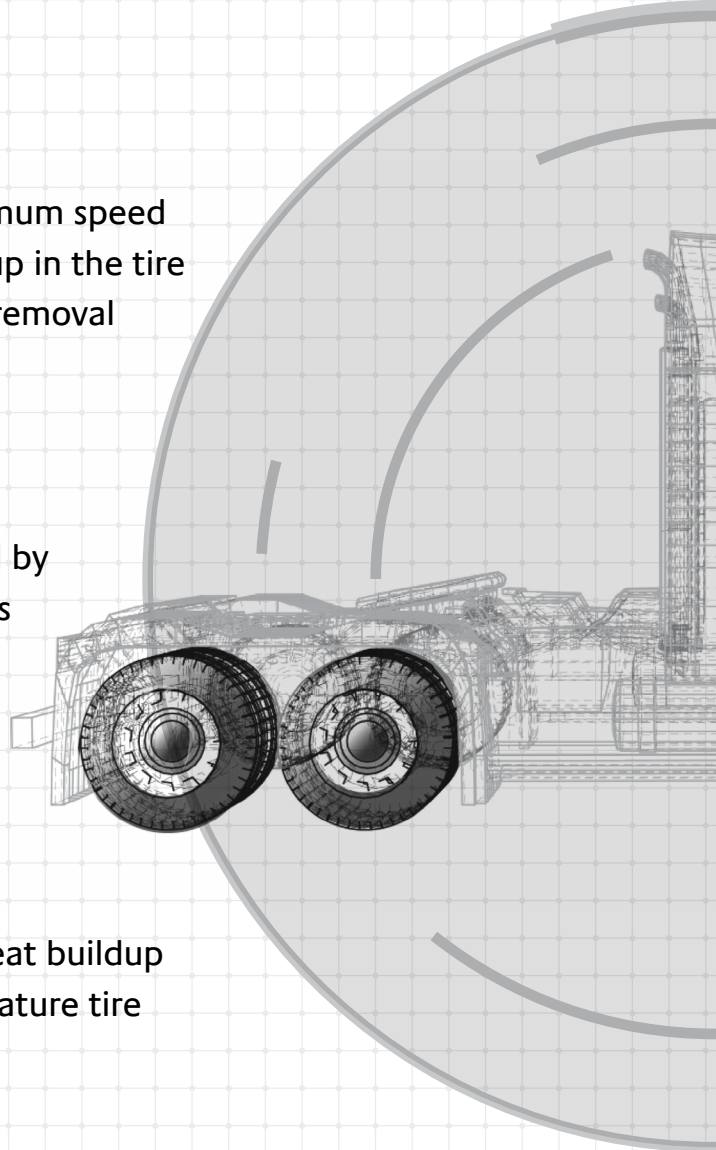

VIEW ADDITIONAL  
TIRE CARE AND  
SERVICE TIPS.

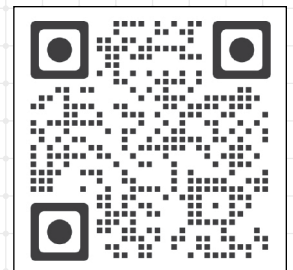

# FACTORS THAT CONTRIBUTE TO HEAT BUILDUP IN TIRES

## VEHICLE INFLUENCED

### Air Flow Restrictive Aerodynamics

Recent evolutions in vehicle aerodynamics, to improve fuel economy, may lead to additional heat buildup in tires due to the lack of cooling pass-by air flow.

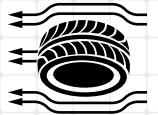

### Engine Emission Control Equipment

Recent evolutions in engine and emission control equipment can elevate temperatures in and around the steer tire fender wells.



## ENVIRONMENTAL INFLUENCED

### Elevated Ambient Temperatures

Ambient temperature is an uncontrollable heat source that has a direct and significant impact on tire heat, especially during the summer in southern states.



*Understanding factors that affect heat in tires is important to maximize tire performance in your operation. Heat damage to tires is cumulative and irreversible. It is critically important to closely monitor and manage tire heat-contributing factors that are within an operator's control. The use of a tire pressure and temperatures monitoring system (TPMS) is highly recommended.*

## DOT Tire ID Number Formats

The U.S. Department of Transportation revised requirements for the tire identification number (TIN) format that tire manufacturers must comply with by April 13, 2025. Prior to that time, the previous format may be used. It is expected that tire manufacturers will be phasing-in use of the latest format. Therefore, tire distributors and retailers will see a mixture of DOT TIN formats used on the variety of tires they sell/service before the latest regulation takes full effect.

The DOT TIN is commonly known as the “DOT number” and is marked in full on at least one sidewall near the bead. Please refer to the infographic below.

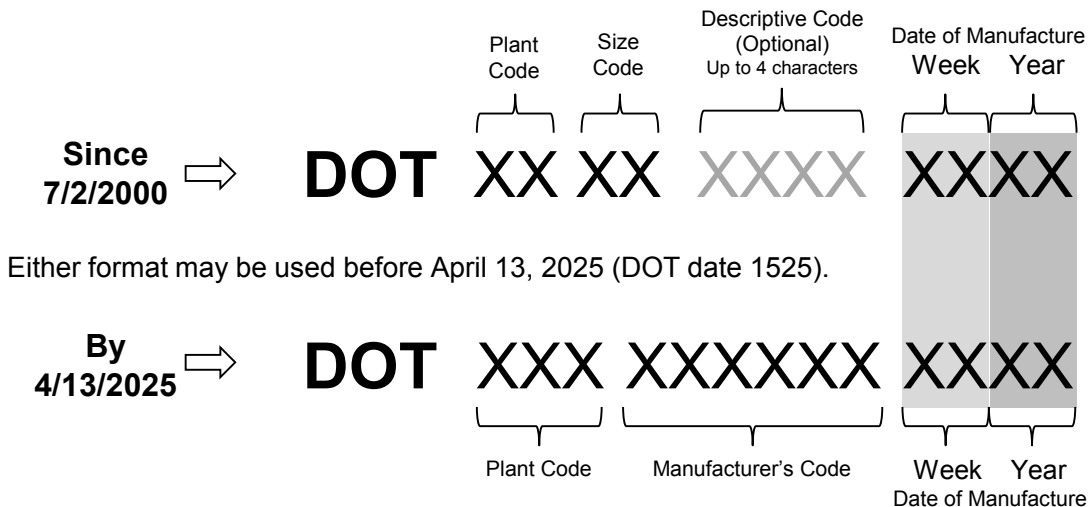

Note that the last portion of the TIN is unchanged—identifying the tire manufacture date using the same format for week and year. (For tires made before 7/2000, there is one digit for the year.)

<i>Date of Manufacture Examples</i>	}	025	=	2 <sup>nd</sup> week of 1995 (possibly 1985 or 1975)
		2608	=	26 <sup>th</sup> week of 2008
		3314	=	33 <sup>rd</sup> week of 2014
		1525	=	15 <sup>th</sup> week of 2025

## Truck/Bus Tire Tread Rubber Worn Color Appearance

The tread rubbers of Bridgestone, Firestone, and Dayton brand truck/bus tires incorporate various technologies to optimize traction, wear, and other tire performance criteria.

For those tires engineered with dual tread compounds, once the outer tread rubber (commonly referred to as cap compound) has worn away, the base tread rubber will become exposed and may be apparent (see examples below). Depending on the design, the base rubber may have a lighter or darker appearance than the outer tread rubber. This color difference is a cosmetic condition as long as the tire is not damaged, has adequate tread depth, and there is no condition that requires further evaluation with a tire service professional or would make it necessary to remove it from service.

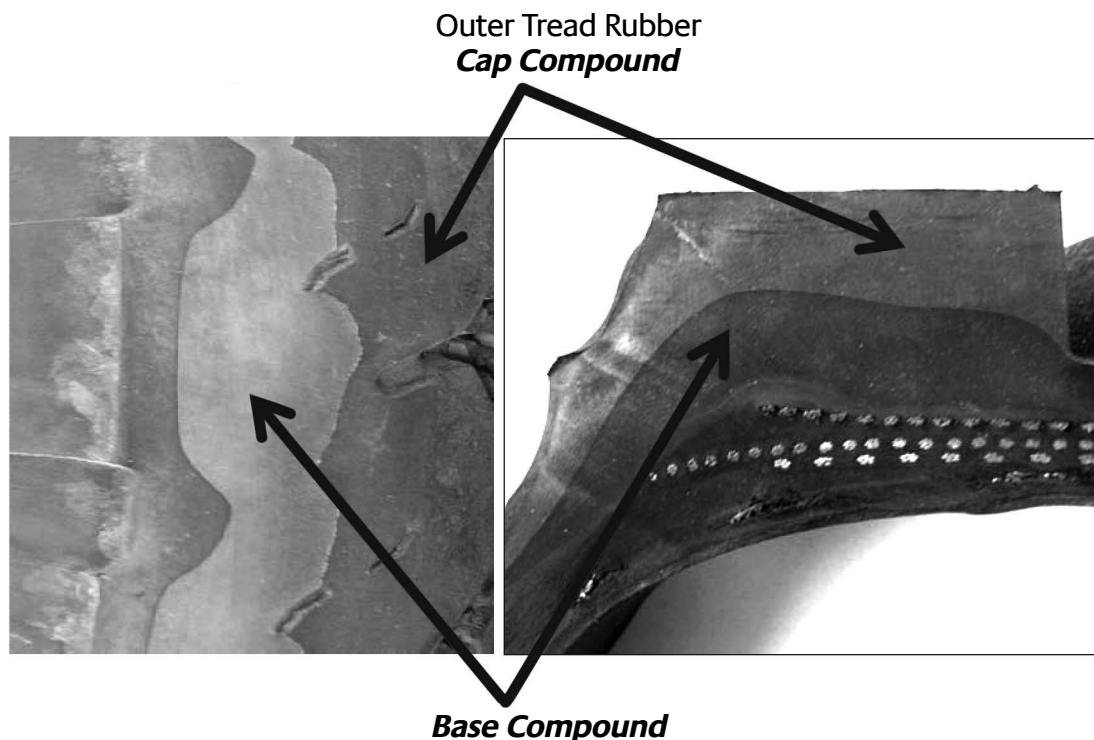

## TBR Sidewall Repair & Identification

### *Background*

Radial truck tires can successfully be repaired in the sidewall area. When damaged body cord is removed and a reinforcing unit is used in the repair process, a radial sidewall bulge may be visible. In 1984, the Rubber Manufacturers Association (RMA) issued a bulletin stating that bulges up to  $\frac{3}{8}$ " in height are permitted when associated with these repairs.

### *Issue*

The Commercial Vehicle Safety Alliance (CVSA) is responsible for inspecting commercial vehicles for safety defects and placing vehicles out of service if defects such as tire separations or exposed cord/fabric are found. The inspectors, in the past have had difficulty distinguishing between sidewall bulges due to repairs (allowed) and tire separations.

### *Action*

In October 1990, the CVSA agreed to accept the use of a blue triangular identification adjacent to a sidewall repair bulge. A vehicle will not be placed out of service if a tire repair bulge is  $\frac{3}{8}$ " or less in height and is identified with an adjacent blue triangle. The retread and repair industry will be incorporating these identification patches into their sidewall repair procedures.

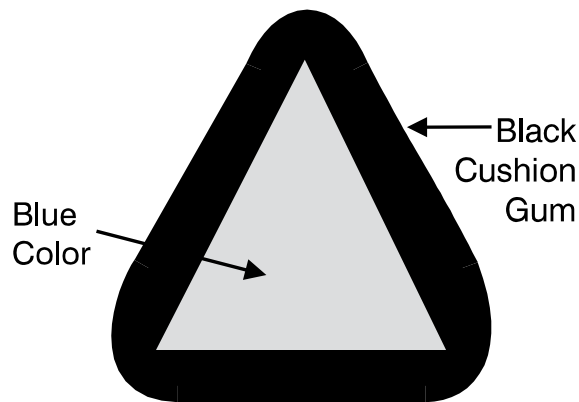

Sample Triangular Identification Patch

Note: Actual Size

## Extra-Deep-Tread Tires' Lateral Stiffness Effects

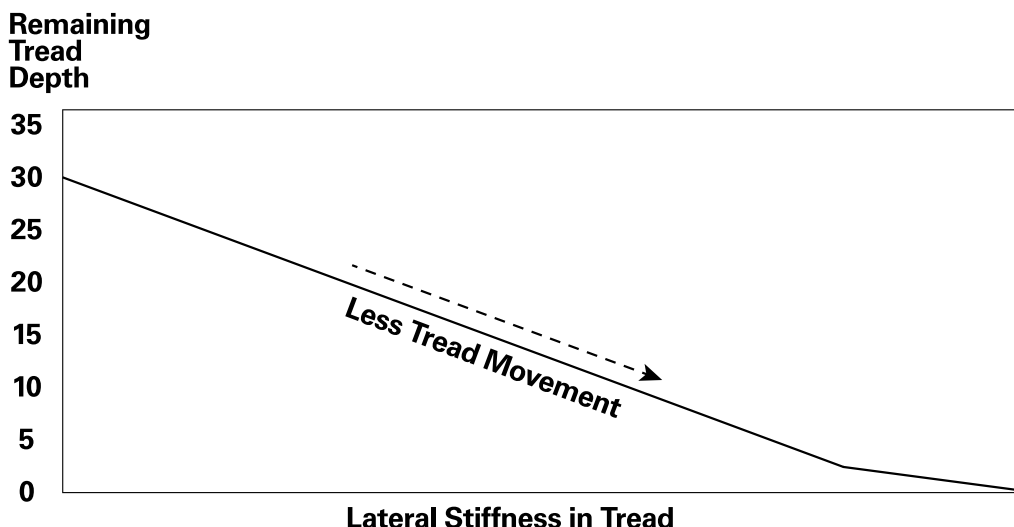

**M**any drivers are aware of the feel of the trucks used on a daily basis in fleets, and are sometimes sensitive to the ride dynamics of fitment changes of new tire designs on the vehicle.

One of the sensations drivers notice is a side-to-side motion. This motion is the byproduct of what is commonly referred to as lateral stiffness.

The lateral stiffness of a tire is due in large part to inflation pressure, as well as the tire's tread depth. Both of these factors vary over time. Reduced inflation pressure and deeper tread depth results in lower lateral stiffness.

Therefore, some users may comment on experiencing a slight swaying with newly installed extra-deep-tread drive tires, especially under full load or after replacing worn drive tires.

The sensation the driver feels is the lateral stiffness effect of the extra-deep-tread drive tire compared to the worn tire being replaced and does not affect traction or warrant any concerns.

The lateral stiffness improves quickly as the tread wears and a driver will become accustomed to the initial difference in sensation.

## Bridgestone Firestone Chassis Dynamometer Test Guidelines for Truck/Bus Tires

### *I. Background*

Vehicle manufacturers and many maintenance facilities conduct in-place vehicle testing on twin-roll chassis dynamometers. Testing is usually conducted over a short period of time on empty vehicles. If the following procedure is not adhered to, irreversible damage may occur to the tire.

### *II. Procedure*

To prevent excessive head buildup in the center of the tire tread, follow the recommended time period based on roller diameter as listed below:

Maximum Allowable Time by Roller Diameter	
8-5/8" Roller	18" Roller
3.5 minutes	6 minutes

Maximum Allowable Speed is 55 mph.

**Load:** These time restrictions apply regardless of the actual load and are, in fact, more critical when the vehicle is tested without a load.

### *III. Precautions*

To avoid the possibility of irreversible tire damage and/or failure during testing, it is important that the following precautions be taken:

- Do not exceed the time and speed restrictions listed in part II.
- Allow at least one hour cool down between tests.
- When it is anticipated that a test will exceed the time/test value established, a worn or "slave" tire should be used in place of the new tire for testing purposes.

Questions regarding test procedures, loads, etc. should be directed to your Regional Field Engineering Office.



Example of Dyno Damage



## **Aftermarket Tire Products & Additives in Truck/Bus Tires**

Bridgestone Firestone does not endorse or prohibit the use of aftermarket tire products. The use of internally applied additives for balance, sealing, cooling, or any other alleged tire performance enhancement in Bridgestone or Firestone brand truck/bus tires will not void the Limited Warranty unless an inspection of the tires reveals damage related to the use of the additive.

## Aerosol Tire Sealer/Inflators

Aerosol tire sealer/inflators have been used by large numbers of motorists each year and an undetermined number of tires now on the road, which have been filled with these devices, may have combustible gases in their air chambers.

Please read carefully and make sure all your employees read the attached publications that have been approved and distributed by the Rubber Manufacturers Association and the National Highway Safety Administration.

### TIRE OR RIM REPAIR SAFETY BULLETIN

#### FACTS YOU SHOULD KNOW...



It is difficult to determine whether a tire has been inflated with a flammable aerosol type tire sealer/inflator. Therefore, if your establishment repairs or works on rims or on pressurized, rim-mounted tires, you should handle all of them as if they contain a flammable tire sealer-inflator.

The gases in the sealer/inflator, which can be poisonous, are combustible inside the tire. An explosion can occur if ANY ignition source is present. Even the insertion of a plug into a steel-belted tire could cause an explosion!



Proper safety precautions to avoid ignition of flammable gases **MUST** be followed during the repair or maintenance of ALL tires or rims.

Failure to follow these precautions and procedures may result in serious or even fatal injury.

#### PRECAUTIONS YOU SHOULD TAKE...



All tires should be handled as if a flammable tire sealer has been used. Do not rely upon the customer, even if he advises you that one has not been used. Customers may neglect to tell you or even may have forgotten they used a sealer/inflator.



Always make sure that the repair area is well-ventilated so that any gases that are present will not accumulate.



Never weld or use a cutting torch on a wheel or rim without first completely removing the tire from the rim. Otherwise, explosions resulting in possible serious or fatal injury can occur, even in the absence of flammable sealer/inflator.



Do not use a tire rasp, plug or any object which could cause sparks on a tire or rim without first completely removing the tire from the rim. These ignition sources could lead to an explosion.



Do not permit smoking or any flame, spark or other ignition source in the area where tires or rims are being kept.



Never add air to a tire treated with a flammable sealer/inflator without completely removing the flammable gas. Air added to a tire containing flammable gas may make it more explosive.

#### **BEFORE BEGINNING REPAIRS OR SERVICE ON ANY RIM OR TIRE, YOU SHOULD ALWAYS FOLLOW THESE SAFETY PROCEDURES:**

Remove the valve stem completely to release the tire pressure in a well-ventilated area, away from sparks or other ignition sources.

After the pressure has been released and before making any repairs, remove the tire from the wheel rim.



If you believe a sealer/inflator has been used, wash the inside of the tire with a detergent/water solution and rinse thoroughly. Allow the tire to dry before repairs are made.



U.S. Department of  
Transportation

# News:

Office of the Assistant Secretary for Public Affairs  
Washington, D.C. 20590

**FOR IMMEDIATE RELEASE**  
Tuesday, September 24, 1991

**CONSUMER ADVISORY**

NHTSA 49-91  
Contact: Skipp Calvert  
Barry McCahill  
Tel. No.: (202) 366-9550

## **NHTSA WARNS ABOUT HAZARDS OF FIXING TIRES FILLED WITH AEROSOL INFLATORS**

The National Highway Traffic Safety Administration (NHTSA) today cautioned motorists and urged workers at service stations and auto and tire repair shops to be careful while fixing tires that have been filled with aerosol inflators.

According to NHTSA Administrator Jerry Ralph Curry, many of the aerosol inflators contain a flammable propellant that can cause an explosion under certain circumstances. "People in the tire repair business especially should be aware of the hazard and take precautions to reduce the risk of an explosion," he said.

Aerosol inflators, marketed under various brand names, are widely sold to the public for temporarily fixing tires that have gone flat because of slow leaks and small punctures, Curry said.

He said that despite flammability warnings on the cans and instructions for safe use, many consumers may be unaware of the potential danger. "Aerosol flat tire fixes should be considered as emergency, temporary repairs and used with caution. It is always preferable to have the tire repaired professionally or replaced.

"After filling a tire with an aerosol inflator, don't expose the tire to extreme heat, flames, sparks or other ignition sources. Be careful using metal tools like tire irons, metal reamers and hammers because they could cause sparks while being used to repair a tire," Curry said.

He noted that because aerosol inflators are used so commonly, consumers and service personnel should assume a tire may have been repaired previously with an aerosol product. "Before starting to fix a tire, remove the valve core and completely deflate the tire to eliminate as much of the aerosol propellant as possible. Then, inflate and deflate the tire a few times to completely remove all traces of the potentially explosive propellant. Once this is done, you may repair the tire without risk of explosion," Curry said.

###

## **Innertube Storage**

Innertubes should always be stored in a sealed enclosure. If the seal is damaged or broken, reseal the enclosure or repackage the affected tubes to prevent premature ozone crack damage on tubes. Exposure to weather, open doors, sunlight, electric motors and fans can cause premature aging of the rubber compound, especially when folded. In addition, tubes stored in tires can be similarly affected if unprotected by a flap or rim.

**Tubes with ozone crack damage should be replaced.  
Do not place these in service.**

## Mismatching Tire Bead & Rim Diameters

**T**here is danger in installing a tire of one rim diameter on a rim of a different rim diameter.

Always replace a tire on a rim with another tire of exactly the same rim diameter designation and suffix letter.

For example a 16" tire goes with a 16" rim. **Never mount a 16" size diameter tire on a 16.5" rim.** While it is possible to pass a 16" diameter tire over the lip or flange of a 16.5" size rim diameter, it cannot be inflated enough to position itself against the rim flange. If an attempt is made to seat the tire bead by inflation, the tire bead will break with explosive force and could cause serious injury or death.

Various materials have been published on the importance of properly matching tire bead and rim diameters prior to attempting to mount the assembly. Listed below is a sampling of that material.

### **Bridgestone:**

#### **1. Technical Bulletin #T9104TD**

##### **Sec. V Tire and Rim Matching Importance**

Remember the importance of proper matching of tires and rims. In particular, special care must also be used in the mounting of any 16" diameter tire sizes, as well as the 15.5" and 17.5" sizes. The 16" size tire must be mounted only

on the approved 16" rims and not the 15.5" or 16.5" rims. In addition, any 15" size tire must be mounted only on approved 15" rims not on the 15.5" rim and any 17" size tire must be mounted only on approved 17" rims not on the 17.5" rim.

If mounting of a 15" diameter tire is attempted on a 15.5" rim, or a 16" tire is attempted to be mounted on a 16.5" rim, or a 17" tire is attempted to be mounted on a 17.5" rim, serious injury or death may result.

#### **2. Tire Label Safety Warning**

##### **Safety Warning**

- Serious injury or death may result from an explosion of tire/rim assembly due to the use of excessive pressure during mounting.
- Never exceed 40 psi (275 kpa) to seat beads. After beads are seated, adjust inflation to pressure recommended by vehicle manufacturer.
- During tire inflation, always have assembly secured, stand clear, and use remote controlled clip on air hose.
- Only specially trained persons should mount tires.
- Mount only on 16 inch\* diameter rims.

*\*Warning: Varies by tire size.*

### 3. Molded Sidewall Safety Warning

#### Safety Warning: Serious Injury may result from:

- Tire failure due to inflation/overloading — follow owner's manual or tire placard in vehicle.
- Explosion of tire/rim assembly due to improper mounting — never exceed 40 psi (275 kpa) to seat beads — mount only 16 inch diameter rims\* — only specially trained persons should mount tires.

\*Warning: Varies by tire size.

### Rubber Manufacturer Association (RMA)

#### 1. Care and Service of Automobile and Light Truck Tires \*

\* Copies from the RMA material can be ordered from:  
Rubber Manufacturers Association  
1400 K Street N.W.  
Washington, D.C. 20005

### WARNING

There is danger in installing a tire of one rim diameter on a rim of a different diameter.

Always replace a tire on a rim with another tire of exactly the same rim diameter designation and suffix letter.

For example a 16" tire goes with a 16" rim. Never mount a 16" size diameter tire on a 16.5" rim. While it is possible to pass a 16" diameter tire over the lip or flange of a 16.5" size rim diameter, it cannot be inflated enough to position itself against the rim flange. If an attempt is made to seat the tire bead by inflation, the tire bead will break with explosive force and could cause serious injury or death.

Rims of a different diameter and tapers cannot be interchanged. The following diagram illustrates the difference between rims of two different tapers and diameters:

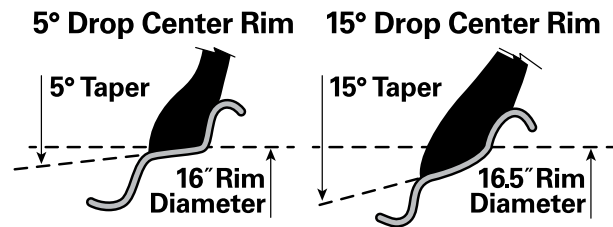

The following diagram shows how the beads of a 16" tire will not seat on a 16.5" rim. The beads cannot be forced out against the rim flanges by using more air pressure, because this will break the beads and the tire will explode.



Mismatching Tire Bead & Rim Diameters **2/3** continues >>>

**WARNING**

**Never inflate beyond 40 pounds pressure to seat beads.**

**Never stand, lean or reach over the assembly during inflation.**

Inspect both sides of the tire to be sure that the beads are evenly seated. If tire mounted on a machine that does not have a positive lock-down devices to hold the wheel, inflation should be done in a safety cage. If both beads are not properly seated when pressure reaches 40 pounds, completely deflate the assembly, reposition the tire and/or tube on the rim, relubricate and reinflate. Inflating beyond 40 pounds air pressure when trying to seat the bead is a DANGEROUS PRACTICE that may break a tire bead (or even the rim) with explosive force, possibly resulting in serious injury or death. After the beads are fully seated, pressure may be increased above 40 psi to operating pressures, not to exceed the maximum labeled on the tire sidewall.

**WARNING**

**Serious Injury May Result From:**

- **Tire failure due to underinflation/overloading – follow owner’s manual or tire placard in vehicle;**
- **Explosion of tire/rim assembly due to improper mounting – only specially trained persons should mount tires.**

**WARNING**

**Tire changing can be dangerous and should be done by trained personnel using proper tools and procedures. Always read and understand any manufacturer’s warning contained in their customer’s literature or molded into the tire sidewall.**

Failure to comply with these procedures may result in faulty positioning of the tire and/or rim parts, and cause the assembly to burst with explosive force, sufficient to cause serious physical injury or death. Never mount or use damaged tires or rims.

**2. “Demounting and Mounting Procedures for Automobile Tires” (Wallchart)\***

**3. “Tire Replacement Guide for Light Trucks” (Wallchart)\***

**Consumer Inquires:**

If questioned by a consumer on this matter, it is recommended that you stress the following areas:

1. Bridgestone tires are designed with adequate strength to withstand mounting and demounting stresses when correctly matched to rims of the correct diameter.
2. All Bridgestone 16” and 16.5” tires carry a safely warning permanently molded into the tire sidewall which directs trained personnel to mount only the approved matching rim (example: “Mount only on 16 inch diameter rims.”)\*

*\*Warning: Varies by tire size.*

## Mounting Tubeless Truck Tires

Proper mounting practices are mandatory to help ensure uniform tire/wheel assemblies for application to heavy duty trucks which use 22.5 and 24.5 bead diameter tubeless truck tires. Failure to follow the industry recommendations for mounting uniformity may result in improper tire bead/wheel fit and can lead to vehicle vibration and irregular tire wear.

Bridgestone recently conducted a tire mounting study involving tubeless tires of different brands, aspect ratios and bead diameters on new and used steel and aluminum wheels. Bridgestone tires included in this study were R299, R194-LP, R293 and R194 designs.

Results of the evaluation showed that regardless of the item combination checked, uniform assemblies were obtained when the following three practices were performed:

1. Clean the wheel or rim
2. Lubricate the tire and beads  
AND WHEEL/RIM BEAD SEAT
3. Check the assembly for concentricity

1. A used wheel/rim should be cleaned by wire brushing to remove rust, scale and build-up. Painting the cleaned metal with primer or anti-rust paint is recommended.
2. Before assembling tire and wheel/rim, lubricate tire beads and wheel/rim seat with a vegetable oil-based lubricant formulated for tire and wheel/rim use. Do not use petroleum- or solvent-based products, as they cause rubber deterioration.

Failure to lubricate the wheel/rim as well as the tire can lead to a non-uniform assembly.

The best initial balance is obtained by matching the tire's light spot (marked by a yellow dot or circle) at the wheel/rim valve.

3. To check the assembly for concentricity of a tire and wheel/rim, measure the distance between the tire-flange interface and the circumferential ring molded into the

tire sidewall at four locations (90 degrees apart) around the tire-flange circumference. Distances measured should be within a  $2/32"$  (1.5 mm) range for acceptable uniformity. If the ranges in distance within the same side of the tire are greater than this, break down assembly, re-lubricate and remount the tire.

Following these practices will reduce vehicle vibration and irregular wear occurrences. The first step in investigating these types of complaints should be the measurement of tire and wheel/rim concentricity to determine if non-uniform mounting is present, and the probable cause. If so, break down assembly, re-lubricate tire and wheel and remount tire.

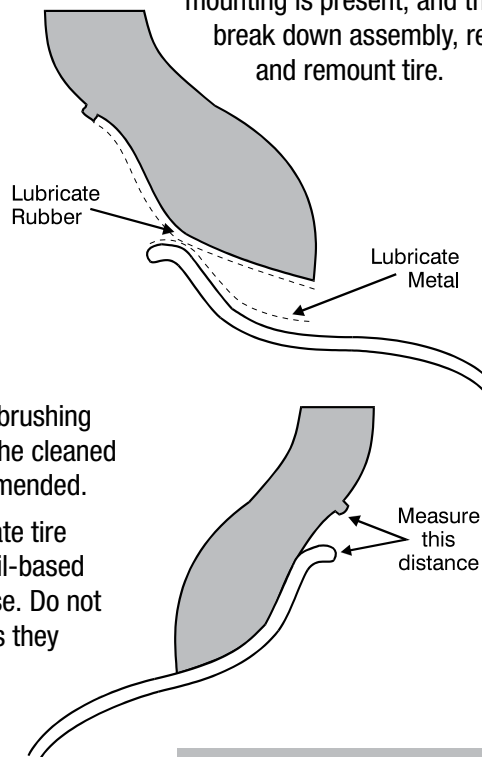

**REMEMBER:  
CLEAN! LUBRICATE! CHECK!  
AND ALWAYS FOLLOW ALL  
OSHA, RMA, AND MANUFACTURER  
MOUNTING SAFETY PRECAUTIONS!**



## **Steam Cleaning Tires**

**CAUTION:** Steam cleaning can damage a tire and render it unserviceable.

At many businesses throughout the United States, it is common practice to use “steam cleaning equipment” to wash trucks and tires.

Nozzle temperature on steam cleaning equipment typically reaches 280°F.

When a steam cleaning nozzle is held too close to the sidewall of a tire for as short a time as 45 seconds, a small spongy blister may appear on the sidewall. When this blister is cut open, one will observe reverted rubber resulting from the excessive localized heat.

Steam cleaning of tires can be harmful to tires when the nozzle is concentrated in one spot for a period of time.

# 2023 MEDIUM TRUCK TIRE COMPARISON GUIDE



## **FS591** ..... pg 9 *Fuel-Efficient Steer Tire*

Long & regional haul all-position steer featuring a proprietary shoulder design with the Equalizer Rib™ and Defense Groove™ designs to combat the initiation and spread of irregular wear.

EPA SmartWay® verified and CARB compliant.

**Replaces:**

- Goodyear **Marathon LHS**
- Continental **EcoPlus HS3+, EcoPlus HS3**
- Yokohama **101ZL** Hankook **AL21, AL11**

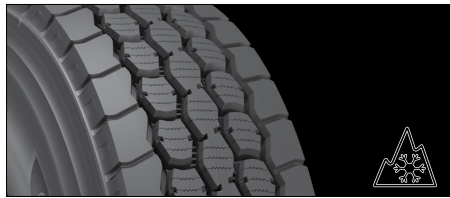

## **FD692** ..... pg 10 *Fuel Efficient Drive Tire*

A SmartWay Verified and CARB compliant drive tire designed to reliably reduce fuel-costs without compromising on all-weather dependability and traction.

EPA SmartWay® verified and CARB compliant.

**Replaces:**

- Goodyear **Marathon LHD**
- Yokohama **709ZL**
- Continental **HDL2**
- Hankook **DL12, DL11**



## **FD694** ..... pg 11 *Drive Tire*

Firestone's deepest on-highway drive tire designed to deliver longevity and ensured traction performance across a robust range of applications.

**Replaces:**

- Goodyear **Marathon RSD**
- Continental **HDL2 DL, HDL2 DL+**
- Yokohama **TY517mc2, TY527**
- Hankook **DL21, DL12**



## **FT492** ..... pg 12 *Fuel-Efficient Trailer Tire*

Trailer radial tire recommended for single- and tandem-axle trailer. Defense Groove™ structure helps create uniform pressure at the shoulder to minimize edge wear for long tread life.

EPA SmartWay® verified and CARB compliant.

**Replaces:**

- Goodyear **Marathon LHT**
- Continental **EcoPlus HT3**
- Yokohama **109L** Hankook **TL21**



## **FS400** ..... pg 13 *All-Position Tire*

Ideal for on-highway intercity bus service requiring very heavy load capacity, and ultra-quiet ride.

**Replaces:**

- Goodyear **Marathon LHS II HL**
- Continental **Coach HA3**



## **FD600** ..... pg 14 *Drive Tire*

Ideal for on-highway drive-axle intercity bus service. Features an open-shoulder lug pattern and tread design to help provide aggressive traction on wet and dry conditions.

**Replaces:**

- Goodyear **Endurance TSD**
- Continental **HDR2**



## **FS561A** ..... pg 15 *All-Position Tire*

Excellent for steer position in pickup & delivery service and regional haul applications. Enhanced features for long, even wear and casing durability. Innovative sidewall design to improve fuel efficiency, and protective ribs for curbing and impacts.

EPA SmartWay® verified and CARB compliant.

**Replaces:**

- Goodyear **Marathon RSA, Marathon RSS**
- Continental **HSR2/HSR3**
- Yokohama **108R, 104ZR**
- Hankook **AH24, AH37**



## **FS561** ..... pg 16 *All-Position Tire*

Excellent for steer position in pickup & delivery service and regional haul applications. Enhanced features for long, even wear and casing durability. Innovative sidewall design to improve fuel efficiency, and protective ribs for curbing and impacts.

**Replaces:**

- Goodyear **G647 RSS**
- Continental **HSR+**
- Yokohama **104ZR, 124R**
- Hankook **AH35**



## **Transforce AT<sup>2</sup> Commercial** ..... pg 17 *All-Position Tire*

Long & regional haul radial recommended for steer, tandem- and single-drive axle applications. Optimized tread design maximizes the balance of wear and traction performance in all weather conditions.

**Replaces:**

- Goodyear **G622 RSD**
- Continental **HSR+, HDR+**
- Yokohama **115R, 714R, 720R**
- Hankook **DH07, DH35**



**FD711** ..... pg 18  
*Drive Tire*

Drive radial specifically recommended for high-traction and high-scrub applications in long- and regional-haul service, light-to-moderate on-/off-highway service, and pickup-and-delivery service.

**Replaces:**

- Goodyear **Marathon RTD**
- Continental **HDR2, Hybrid HD3**
- Yokohama **715R**
- Hankook **DH06**



**FS860** ..... pg 19  
*All-Position Tire*

All-position radial tire engineered specifically for refuse, high-scrub, short-haul applications. Stone rejector platforms prevent trapped stones from pushing deeper into tread grooves and piercing belt layer, damaging belts and exposing them to rust.

**Replaces:**

- Goodyear **G289 WHA**
- Continental **HAU 3 WT**
- Yokohama **MY627W**
- Hankook **AM09**



**FS821** ..... pg 20  
*On/Off-Highway All-Position Tire*

A dependable, durable and long wear all position tire with traction to deliver excellent performance cost per mile in on/off highway application.

**Replaces:**

- Goodyear **G751 MSA, G731 MSA**
- Continental **HSC3, HSC1**
- Yokohama **MY507, 504C**
- Hankook **AM09**



**T819** ..... pg 21  
*On/Off-Highway All-Position Tire*

Rugged, four-rib on/off-highway all-position radial, featuring cut-resistant compounds for long tread life.

**Replaces:**

- Goodyear **Workhorse MSA**
- Continental **HSC3**
- Yokohama **MY507**
- Hankook **AM09**

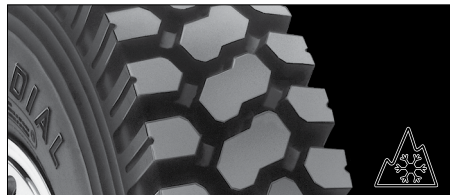

**T831** ..... pg 22  
*On/Off-Highway Drive Tire*

An on/off-highway drive tire with a deep and wide tread design to help provide excellent mileage, high traction and irregular wear resistance.

**Replaces:**

- Goodyear **Workhorse MSD**
- Continental **HDC1 HT**
- Yokohama **LY053**
- Hankook **DM04**



**FS818** ..... pg 23  
*On/Off-Highway All-Position Wide Base Tire*

A wide base design for higher payloads and special tread compounds to help resist cuts, chips, tearing and irregular wear.

**Replaces:**

- Goodyear **G296 MSA**
- Continental **HAC3**
- Yokohama **MY507A**
- Hankook **AM15**

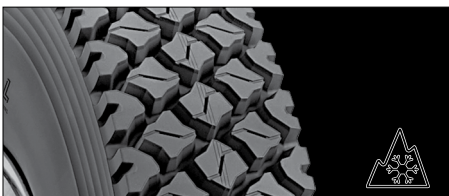

**FD835** ..... pg 24  
*On/Off-Highway Drive Tire*

An on/off-highway drive tire includes block design with angled siping helps to provide aggressive traction for both on and off highway use and a tough tread compound helps resist cuts, chips, chunks, and tears.

**Replaces:**

- Goodyear **G741 MSD**
- Continental **HDO**
- Hankook **DM09**

# 2023 MEDIUM TRUCK TIRE COMPARISON GUIDE

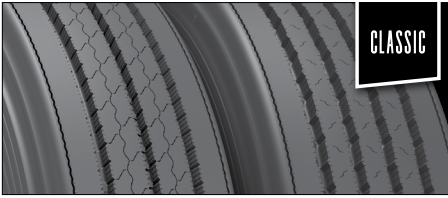

**FS509** ..... pg 26  
*Steer Tire*

A shoulder-wear protector, stress relief sipes, and a continuous shoulder rib work together to fight irregular wear and reduce rolling resistance. A wider casing increases the potential of multiple service lives.

EPA SmartWay® verified and CARB compliant.

**Replaces:**

- BF Goodrich **HW Control S**
- Toyo **M137, M177**
- General **HS**

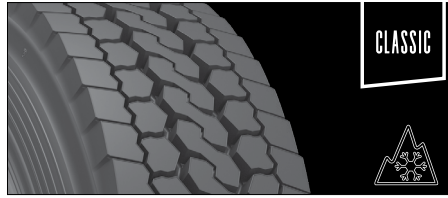

**FD609** ..... pg 27  
*Drive Tire*

Offers features such as aggressive center lugs with multiple biting edges to help promote traction in wet or dry conditions, and a wider casing to increase the potential of multiple service lives.

**Replaces:**

- BF Goodrich **DR44**
- Toyo **M647**
- General **HD**

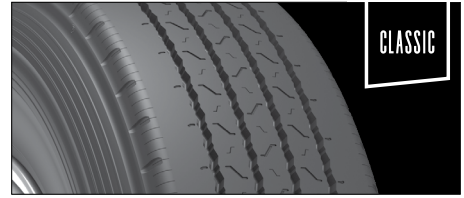

**FT409** ..... pg 28  
*Trailer Tire*

Leverages proven technologies to deliver unbeatable treadwear and mileage plus the additional benefits of casing durability and retreadability. A wider casing increases the potential of multiple service lives.

EPA SmartWay® verified and CARB compliant.

**Replaces:**

- BFGoodrich **HW Control T**
- Toyo **M157**
- General **HT**

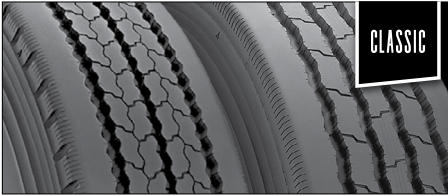

**FS560 PLUS** ..... pg 29  
*All-Position Tire*

All-position tire for use in urban, high-scrub service in pickup & delivery and regional haul applications.

**Replaces:**

- BFGoodrich **Route Control S**
- Toyo **M170, M122**
- General **RA**



**FD663** ..... pg 30  
*Drive Tire*

Drive radial with open-shoulder design to help provide sure traction and grip in mud and snow. Recommended for high traction and high scrub drive-axle applications.

**Replaces:**

- BF Goodrich **Route Control D**
- Toyo **M610**
- General **RD**

# 2023 LIGHT TRUCK TIRE COMPARISON GUIDE



## **Transforce HT<sup>2</sup>/CV** ... pg 37

Tread design provides great chip and tear resistance. Delivers solid traction in wet conditions. Optimized profile to help improve uneven wear, even with heavy loads.

**Replaces:**

- BF Goodrich **T/A All Season**
- Goodyear **Wrangler SR-A**



## **Transforce AT<sup>2</sup>** ..... pg 38

Built with a chip and tear resistant compound. Deeper tread features improve traction in rain, snow and dry conditions. Innovative tread-to-road contact footprint help performance for longer tire life.

**Replaces:**

- BF Goodrich **T/A Traction**
- Goodyear **Wrangler Silent Armour**

TIRE CARE & SERVICE TIPS  
FOR COMMERCIAL TRUCK TIRES

- » **Do not exceed your tire's maximum recommended speed which may be lower than posted speed limits**
- » **Select the right tire for the job considering the proper tire size, load carrying capacity, speed capability and service type**
- » **Set and maintain proper cold inflation pressures**
- » **Inspect your tires frequently for damage such as cuts, cracks, bulges and penetrations**



FIRESTONE TECHNICAL SERVICE

800.847.3272

• WEST

CENTRAL •

★ • EAST

★ HOME OFFICE ★

615.937.1000  
200 4th Avenue South  
Nashville, TN 37201

---

<b>WEST</b> 2500 South Doubleday Ontario, CA 91761	<b>CENTRAL</b> 2100 Internationale Pkwy Woodridge, IL 60517	<b>EAST</b> 201 Bridgestone Pkwy Lebanon, TN 37090
--	---	--

**Firestone**

[Commercial.Firestone.com](https://Commercial.Firestone.com)